



EMOS[®]

A brand of **legrand**[®]

Product Catalogue 2024/2025



GoSmart		Home security	Luminaires and light sources	Wiring and control	Measurement and control	Household and garden				
Batteries		GP				RAVER				EMOS
		Alkaline	Carbon zinc	Other	Rechargeable	Lithium	Alkaline	Rechargeable	Other	Lead acid batteries
Battery chargers, powerbanks, USB chargers		Battery chargers	Powerbanks	USB chargers	Universal adaptors	Car battery chargers, testers				
Portable lighting		GP	EMOS							
Lighting	Light sources	LED bulbs	Light bulbs for electrical appliances	ECO halogen	LED tubes, tubes					
	Luminaires	Highbays	Dustproofs	Street lights	Floodlights	Work lights	Linear luminaires	LED panels	Drivers	Surface luminaires
		Pendant luminaires	Recessed luminaires	Emergency luminaires	Orientation luminaires	Cabinet luminaires	Desk and floor lamps	Sensors	Decorations	
Weather stations, thermometers, scales, others		Weather stations	Thermometers	Spare sensors	Kitchen, hanging scales	Kitchen timers	Personal scales	Air quality GoSmart	Bathroom scales GoSmart	
TV and audio accessories		Multimedia players, radios	TV wall mounts	Universal remote controllers OFA						
Power supply extension cords, cable reels, plugs, accessories		Power supply extension cords and sockets	Surge protectors	Assembled cords	Cable reels	Sockets, plugs, adaptors, timers, others	Industrial plugs, 380 V sockets	Flexo, assembled cords		
Cables		Data cables UTP, FTP	Connectors, patch accessories	Twin-shielded cables CYH	Coaxial cables	Connection AV cables	Smartphone cables	Solid, flexible cables	Solar cables	
HF signal receiving components, antennas, small electronic, accessories		Antennas	TV signal receivers	Wall sockets	Accessories					
Videophones, doorbells		Home videophones, sets	Cameras, surveillance	Doorbells	Sensors GoSmart					
Multimeters, testers		Multimeters, measuring cables	Testers	Measuring instruments						
Thermostats, CO and smoke alarms		Thermostats	CO and smoke alarms	Valve closer GoSmart	Detectors GoSmart					
Installation material, tapes		Installation material	Tapes							



PERSON and PRODUCT

*„The product is a mirror of our needs
and our desire to make life easier.“*

EMOS®

A brand of  **legrand®**

Making life easy

Specialist in small household electronics! We enjoy developing, sourcing, and delivering electrical products that help our business partners succeed in today's highly competitive marketplace with their optimum price and quality.

For over 30 years, EMOS companies have offered small household electrical products that are part of everyone's life. Under the EMOS brand, there are mainly batteries, light sources, luminaires for domestic and industrial use, extension leads, flashlights, antennas and small electronic devices – multimeters, testers and bells. In five countries, there are over 450 people employed to ensure that our products are of the best quality and get delivered to you, our customers, as quickly as possible. Since 2022, we have become part of the prestigious multinational Legrand Group, providing us with further opportunities to innovate and improve our service to you.



Direct distributor for the Czech Republic, Slovakia, Hungary, Slovenia and Croatia.

www.emos.eu

EMOS basic philosophy



**OPTIMAL PRICE/
QUALITY RATIO
OF PRODUCTS**

Each product is subject to strict quality control by a team of inspection staff directly at the manufacturer's site and our laboratory. We carry out nearly 1,100 tests a year, supervised by 25 specialists.



**24-HOUR
STOCK
AVAILABILITY**

We offer excellent stock availability of our products and fast delivery to our customers. A total storage area of over 16,000 m² allows us to keep more than 95% of the items in our range in stock and in sufficient inventory.



**SPEED AND
EASE OF
COMMUNICATION**

Customers communicate with us in the way that suits them best - through sales representatives, online B2B and B2C portals or by phone. 90 EMOS Group sales representatives visit an average of 650 customers per day

About the multinational Legrand Group

Legrand is a global electrical and digital infrastructure specialist, offering high-value-added products and solutions that improve lives by transforming the spaces where people live, work, and meet. The Legrand Group employs more than 38,200 people in nearly 90 countries and works to improve buildings' electrical and digital infrastructures, helping to digitize them and reduce their carbon footprint. Legrand has solutions for all building types - residential buildings, data centers, other non-residential buildings, industrial spaces, and infrastructures. The Group's technological expertise, leadership position, the breadth and diversity of its offerings, its international presence, and the strength of its brands combine to make Legrand a global leader.

[#LegrandImprovingLives](https://www.legrandgroup.com)

www.legrandgroup.com

[@legrand](https://twitter.com/legrand)

EMOS dealership

CZECH REPUBLIC

Headquarters and logistics centre

EMOS spol. s r.o.
Lipnická 2844
750 02 Přerov

ID No.: 19014104
tax ID No.: CZ19014104
bank account number: 296149831/0100
e-mail: emos@emos.cz

contact person: +420 581 261 111
customer centre B2B: +420 581 261 270
customer centre B2C: +420 581 261 233
sales fax: +420 581 701 332

warehouse: +420 581 261 160 / 290 / 293
complaints: +420 581 261 281
GPS: 49.467587°N, 17.448671°E

Office Prague

EMOS spol. s r.o.
PB Park, Průmyslová 1306/7
102 00 Praha 10 – Hostivař

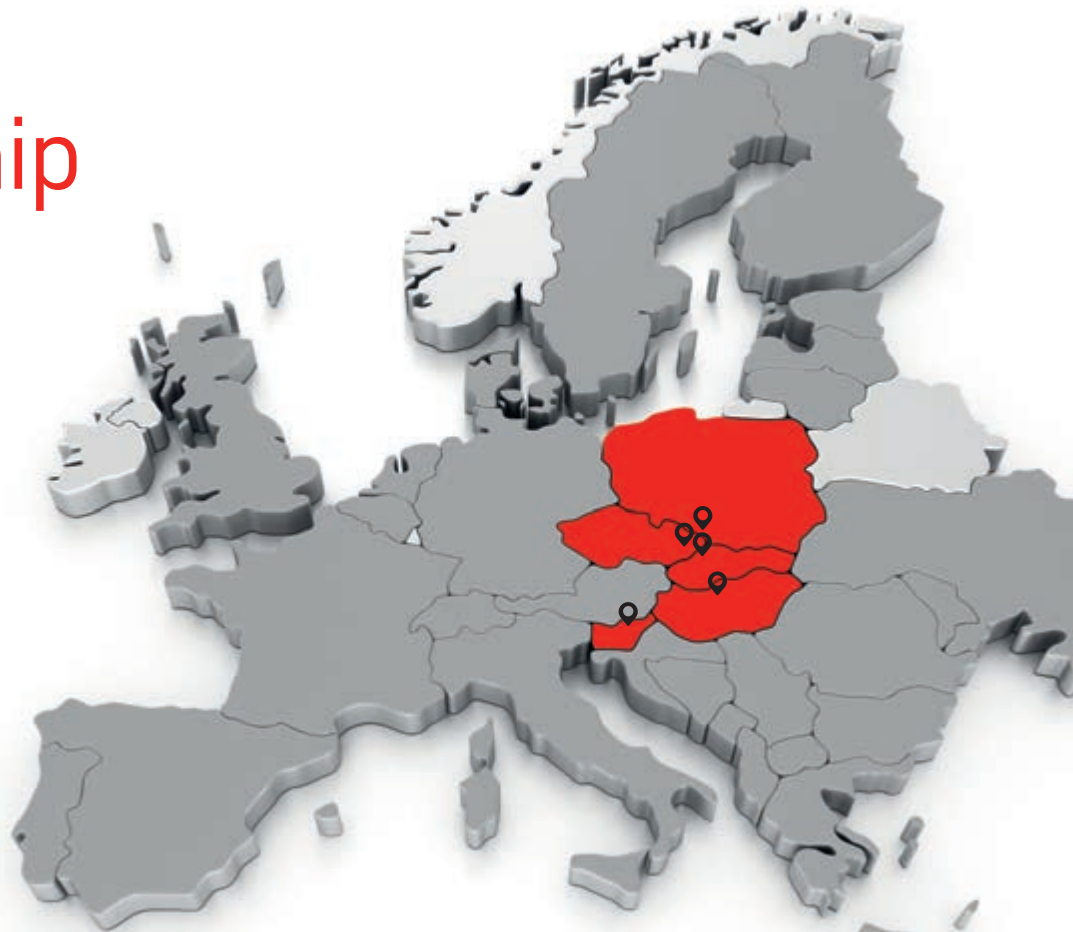

SLOVAK REPUBLIC

EMOS SK s.r.o.
Hlinická 409/22
014 01 Bytča

ID No.: 36392961
VAT No.: SK2020104834
e-mail: info@emos.sk

Sales department: +421 41 50 916 14
+421 902 96 69 96

Secretariat: +421 41 509 16 11

POLAND

EMOS PL Sp. z o.o.
ul. Gątczyńskiego 6
43-300 Bielsko-Biała

tel.: +48 33 816 92 42
e-mail: biuro@emos.pl

SLOVENIA

EMOS SI, d.o.o.
Rimska cesta 92
3311 Šempeter v Savinjski dolini

tel.: +386 8 205 17 20
e-mail: narocila@emos-si.si

Croatia | Bosnia and Herzegovina | Serbia | Montenegro | North Macedonia

Sašo Marinšek
Managing Director EMOS SI, d.o.o.
GSM: +386 31 517 364
e-mail: saso.marinsek@emos-si.si

HUNGARY

EMOS HU Kft.
Budaörs Office Park, A épület
2040 Budaörs, Szabadság út 117.

tel.: +36 70 398 5891
fax: +36 23 41 42 99
e-mail: info@emos.hu

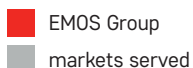

Albania | Belgium | Bosnia and Herzegovina | Bulgaria | Montenegro | Denmark | Estonia | Finland | France | Croatia | Italy | Latvia | Lithuania | Cyprus | Hungary | Moldova | Germany | Netherlands | Poland | Portugal | Austria | Romania | Greece | North Macedonia | Slovakia | Slovenia | Serbia | Spain | Sweden | Ukraine

EXPORT

Export departement + Germany | Austria | Sweden

Ladislav Novak
Export Manager
phone: +420 581 261 207
GSM: +420 724 597 640
e-mail: ladislav.novak@emos.cz

Latvia | Estonia | Lithuania | Finland

Raman Sinevich
Country Manager
Baltic countries
GSM: +371 295 901 79
e-mail: raman.sinevich@legrand-ext.com

Spain | Portugal | France | Greece | Netherlands | Italy | Denmark | Belgium

Jose Henriquez
Export Sales Manager
Phone: +420 581 261 127
GSM: +420 602 551 726
e-mail: jose-luis.henriquez@emos.cz

Romania | Bulgaria | Republic of Moldova | Albania

Cseh Szabolcs
Country Manager
Baltic countries
GSM: +40 745 536 783
e-mail: szabolcs.cseh@legrand-ext.com



The Eurologistics Centre of EMOS Holding, with an area of over 16,000 m², supports EMOS' strategy to offer its business partners excellent stock availability of products from its range.

EMOS GoSmart

Smart living is even more accessible

Create your own smart home with EMOS GoSmart and other TUYA-compatible smart devices. Connect individual products, set up automation for their activities and control them remotely with a fully localized and intuitive mobile app.



HOME SECURITY

- Indoor IP cameras
- Outdoor IP cameras
- Video door phones
- Video doorbells
- Sensors
- Access control systems



MEASUREMENT AND CONTROL

- Thermostats
- Weather stations and Thermometers
- Regulating Valves
- Air Quality



WIRING AND CONTROL

- Scenic switches
- Smart hubs
- Extension cords
- Sockets
- Modules



LUMINAIRES AND LIGHT SOURCES

- Bulbs
- Strips
- Luminaires
- Christmas lighting
- Floodlights
- Garden lighting
- Ambient lighting



HOME AND GARDEN

- Scales
- Feeders
- Irrigation Systems



EMOS GoSmart

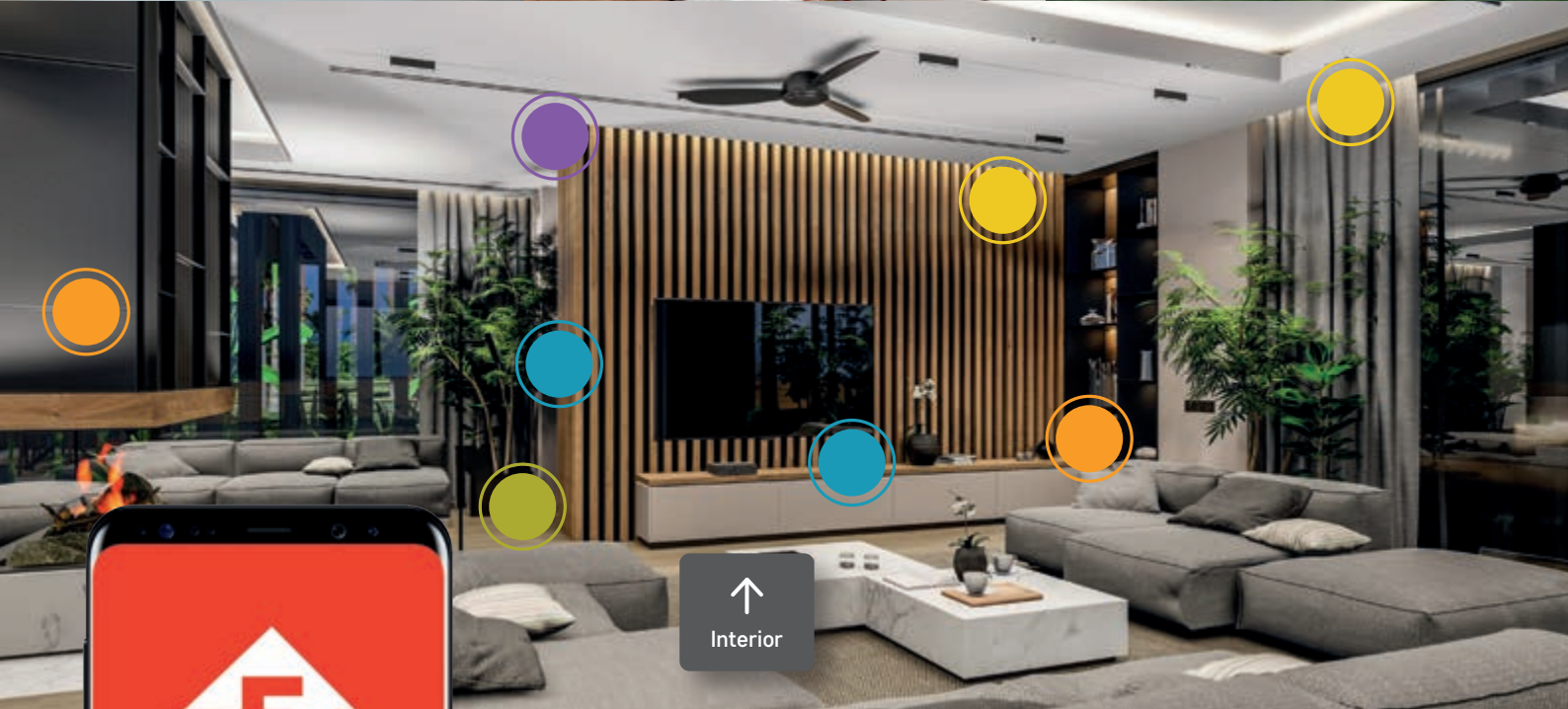

EMOS GoSmart is here to make your life more pleasant, safer, and comfortable.



www.emosgosmart.eu

EMOS GoSmart products

Optimal price/quality ratio

With the affordable prices and excellent quality of EMOS GoSmart products, the smart home system becomes accessible to everyone. You can easily create your smart home without complicated renovation and equipment installation.



WIDE RANGE OF PRODUCTS

Dozens of EMOS GoSmart products are developed by the world's leading manufacturers.



OPTIMAL PRICE AND QUALITY

EMOS GoSmart products are subject to quality control directly at the manufacturer's and in our laboratory.



THE ONLY MOBILE APP

The EMOS GoSmart app allows you to control your device via your mobile phone from anywhere.



TECHNICAL SUPPORT

We provide technical support and help to get EMOS GoSmart products up and running.



COMPATIBILITY AND EXPANDABILITY

Expand your smart home with EMOS GoSmart products and thousands of other TUYA compatible products.



Advanced technology

EMOS GoSmart products communicate via Wi-Fi network, Bluetooth, or ZigBee communication protocols. You can even use voice control thanks to their compatibility with Amazon Alexa and Google Assistant.



Powered by



Data security and compatibility

EMOS GoSmart priorities

The basis of the EMOS GoSmart system is the **global TUYA platform**. This platform meets the most demanding security requirements and, using encrypted communication, allows you to connect the devices in your smart home, keeping them compatible and easy to use.

Renowned brands that have chosen the **TUYA platform for their smart devices include HAMA, LIDL, LEDVANCE, PHILIPS, and many others.**

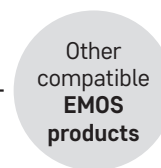

EMOS GoSmart app

Full localization and ease of use

The EMOS GoSmart app makes it easy to control all your smart home devices via your **Android** or **iOS** mobile phone or tablet. The perfect localization allows you to communicate with the app in your native language.



Smart
control
of your
home

Control
multiple
devices



Never
miss
a visit



Create and use
smart
scenarios



Connect
from
anywhere

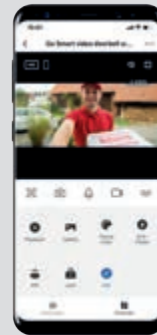

Share with
your family
with one tap



Without complicated settings, you can keep track of any activities in your home with the EMOS GoSmart app and control conveniently all your devices remotely.



FULL LOCALIZATION

Full localization allows you to communicate with the app in your native language.



EASY TO USE

You don't have to worry about complicated app controls. Anyone can handle it.



SMART SCENARIOS

Have your products work together using the smart scenarios.



DEVICE MANAGEMENT

All your smart home devices can be controlled from anywhere using the app.



SMART NOTIFICATIONS

The app sends you notifications about any activity in your home.

EMOS GoSmart is here to make your life more pleasant, safer, and comfortable.

GoSmart	4	Headlights	78
Home Security	4	GP Xplor	78
Indoor IP cameras	4	GP Discovery	79
Outdoor IP cameras	5	EMOS	81
Video door phones	6	LED Metal Flashlights	81
Video doorbells	7	ULTIBRIGHT Flashlights	81
Entry code keypads	8	EMOS Flashlights	82
Sensors	8	EMOS	84
Luminaires and Light Sources	10	LED Plastic Flashlights	84
Bulbs	10	LED Headlights	86
Luminaires	12	LED Work Lights	89
Christmas Lighting	13	LED Rechargeable Work Lights	89
Wiring and Control	14	LED Work Lights	92
Scenic switches	14	LED Work Lights – 230 V	93
Zigbee gateways	15	EMOS	94
Sockets	16	LED Rechargeable flashlights EXPERT	94
Modules	17	LED Bike Lights	95
Measurement and Control	20	LED Night Lights	96
Thermostats	20	LED Battery Night Lights	96
Weather stations and Thermometers	21	LED 230 V Night Lights	97
Air quality	22	EMOS	99
Control valves	22	LED Flashlights display box	99
Household and Garden	23	LED Keychains display box	102
Bathroom Scales	23	Insect killer	103
Batteries	24	Spare parts	103
GP Batteries	24	Lighting	104
GP Consumer batteries	24	Light sources	104
GP Alkaline	24	LED bulbs	104
GP Ultra Plus	24	Filament	104
GP Ultra	26	Classic	115
GP Super	29	Basic	133
GP Carbon Zinc	33	GoSmart Bulbs	138
GP Greencell	33	Light sources	140
GP Supercell	36	Light bulbs for electrical appliances	140
GP Other batteries	37	ECO halogen	141
GP Lithium cylindrical	37	LED tubes, tubes	142
GP Lithium button	39	PROFI PLUS	142
GP Special alkaline	45	BASIC	144
GP Alkaline button	47	Luminaires	145
GP Silver oxide	49	Highbays	145
GP Zinc air	51	PROFI PLUS	145
GP Rechargeable	52	ASTER	145
GP ReCyko Pro	52	PROFI	148
GP ReCyko	53	CORUS	148
Raver Batteries	57	Highbays	149
Raver Lithium cylindrical	57	Accessories	149
Raver Alkaline	58	Dustproofs	150
Raver Ultra	58	PROFI PLUS	150
Raver Batteries	59	MISTY	150
Raver Rechargeable	59	PROFI	152
Raver Other batteries	60	FESTY	152
Raver Lithium button	60	ESSENTIAL	153
Batteries EMOS, lead acid battery	61	DUSTY	153
Lead acid batteries	61	Street Lights	154
Battery chargers, powerbanks, USB chargers	64	PROFI	154
Battery chargers	64	SOLIS	154
Charge 10	64	Floodlights	155
GP Battery chargers	65	PROFI PLUS	155
EMOS Battery chargers	67	AVENO	155
Powerbanks	68	PROFI	158
GP Powerbanks	68	INOVO	158
EMOS Powerbanks	70	CLASSIC	161
USB chargers	71	ILJO	161
Universal adaptors	72	TAMBO	163
Car battery chargers, testers	73	ESSENTIAL	165
Portable Lighting	75	SIMPO	165
GP	75	Floodlights	167
Flashlights	75	Accessories	167
GP Discovery	75	Work Lights	168
GP Everyday	77	PROFI	168

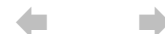

CANNO	168	AMAL	226
CLASSIC	169	DIRAL	227
ILIO	169	DIRBI	228
HOBBOY SLIM	170	Cabinet Luminaires	229
ACCO	170	CLASSIC	229
Linear Luminaires	171	TIGO	229
PROFI PLUS	171	Luminaires	230
ORTO	171	Desk and Floor Lamps	230
LED Panels	173	Sensors	236
PROFI PLUS	173	Decorations	238
PROXO	173	Smart chains	238
PIXO	175	Chains GoSmart	238
LEXO	175	Decorations	240
TROXO	176	Party	240
VEXO	177	Lantern	241
EXCLUSIVE	178	LED candles	241
RIVI	178	Weather stations, thermometers, scales, others	243
PROFI	179	Weather stations	243
MAXXO	179	Weather stations	243
REXXO	180	Thermometers	246
ESSENTIAL	181	Thermometers	246
DAXXO	181	Thermometers GoSmart	249
LED Panels	182	Spare sensors	249
Accessories	182	Kitchen, hanging scales	251
Luminaires	183	Kitchen timers	253
Drivers	183	Personal scales	254
Surface Luminaires	184	Air quality GoSmart	255
EXCLUSIVE	184	Bathroom scales GoSmart	255
RIVI	184	TV and audio accessories	256
ALVI	185	Multimedia players, radios	256
ILVI	186	TV wall mounts	256
LIVI	186	Universal remote controllers OFA	258
ILVI GoSmart	187	Power supply extension cords, cable reels, plugs, accessories	261
PROFI	188	Power supply extension cords and sockets	261
NEXXO	188	FRENCH	261
TIVI	194	Single socket extension cords	261
DIONI	195	Two-cores PVC	261
CLASSIC	197	SCHUKO	262
TORI	197	MOES Extension cords	262
CORI	199	1-phase 16A with rubber insulation	262
DORI	200	1-phase 16A with PVC insulation	263
ZURI	201	Single socket extension cords	269
QARI	202	1-phase 16A with rubber insulation	269
RORI	203	1-phase 16A with PVC weatherproof insulation	270
ESSENTIAL	204	1-phase 16A with PVC insulation	271
RUBIC	204	SCHUKO	272
FIONI	205	MOES	272
FLORI	206	Surge protectors	273
Surface Luminaires	208	Surge protectors EMOS SCHUKO	273
Others	208	Assembled cords	274
Pendant Luminaires	209	3-phase rubber	274
CLASSIC	209	Cable reels	275
Recessed Luminaires	210	SCHUKO	275
EXCLUSIVE	210	3-phase rubber	275
SIMMI	210	1-phase weatherproof PVC	276
PROFI	211	1-phase rubber	277
NEXXO	211	1-phase PVC	279
VIXXO	217	Sockets, plugs, adaptors, timers, others	281
GERI	219	Holders	281
ESSENTIAL	220	Plugs, sockets	282
RUBIC	220	Adaptors	283
Emergency Luminaires	222	Travel adaptors	284
PROFI	222	Timers	284
CESSI	222	Energy consumption meters	286
NESSI	223	GoSmart sockets	286
ORSU	224	Industrial plugs, 380 V sockets	287
Emergency Luminaires	225	Flexo, assembled cords	289
Emergency conversion kit	225	Rubber	289
Orientation Luminaires	226	Two-cores	289
CLASSIC	226	Three-cores	290

PVC	292	Installation material	379
Two-cores	292	Terminal blocks	379
Three-cores	293	Installation material others	380
Cables	296	Transformer solders, copper, rosin	381
Data cables UTP, FTP	296	Tapes	382
Data cables CAT 5E	296	Electroinsulating PVC tapes	382
Data cables CAT 6	299	Other tapes	386
Connectors, patch accessories	300		
Connection patch cables, accessories	300		
Connectors IEC, F, reductions	303		
Twin-shielded cables CYH	306		
Coaxial cables	311		
Coaxial cables 50 Ohm	311		
Coaxial cables 75 Ohm	311		
Connection AV cables	317		
AV cables blister	317		
AV cables polybag	318		
AV cables hanger	318		
AV cables paper blister	319		
Smartphone cables	322		
Solid, flexible cables	326		
Solid cables CYKY-J	326		
Flexible cables PVC CYSY	326		
Solar cables	327		
HF signal receiving components, antennas, small electronic, accessories ...	328		
Antennas	328		
CITY	328		
VILLAGE	330		
PROFI	331		
TV signal receivers	333		
TV signal receivers	333		
Accessories	333		
Wall sockets	334		
Accessories	336		
Combiners, splitters	336		
Amplifiers, preamplifiers, LTE filters	337		
Power supply units for antennas	339		
Holders for satellite, terrestrial antennas	340		
ZigBee GoSmart	341		
Videophones, doorbells	342		
Home videophones, sets	342		
Home videophones	342		
Videophones and video doorbells GoSmart	345		
Accessories for videophones	346		
Cameras, Surveillance	347		
GoSmart Cameras	347		
Doorbells	349		
Wireless doorbells	349		
Spare push buttons	353		
Wired doorbells	355		
Sensors GoSmart	356		
Multimeters, testers	357		
Multimeters, measuring cables	357		
Testers	360		
Measuring instruments	362		
Thermostats, CO and smoke alarms	363		
Thermostats	363		
Thermostats EMOS	363		
Thermostats GoSmart	367		
CO and smoke alarms	368		
Valve closer GoSmart	369		
Detectors GoSmart	370		
Installation material, tapes	371		
Installation material	371		
Sockets, switches	371		
EMOS	371		
IP20	371		
IP54/IP44	374		
Scene switches GoSmart	375		
Modules GoSmart	377		

GoSmart



Home Security

Indoor IP cameras



- For keeping people safe and protecting the interiors of homes
- Alerts of unusual activity sent to mobile devices
- Continuous tracking of moving person for better recording quality
- Two-way voice communication
- Automatic video and audio recording when motion is detected
- Connection to home network via WIFI protocol
- Compatibility with EMOS GoSmart products and TUYA devices
- Voice control with Google Assistant and Amazon Alexa



- automatic image saving
- setting the detection area
- night vision
- camera viewing angle: 100°
- IP rating: IP20
- camera resolution: 1 920 × 1 080
- motion detection
- sound detection
- compatibility: EMOS GoSmart, TUYA, LIDL, Smartlife
- protocol: Wi-Fi
- transmission frequency: 2.4 GHz WIFI
- voice communication: two-way
- motion tracking
- motorised rotation
- motion detection angle: 100°
- motion detection range: 10 meters



H4051 1/-/-12
30 24 040 510 IP-100 CUBE

- automatic image saving
- setting the detection area
- night vision
- camera viewing angle: 100°
- IP rating: IP20
- camera resolution: 2 304 × 1 296
- motion detection
- sound detection
- compatibility: EMOS GoSmart, TUYA, LIDL, Smartlife
- protocol: Wi-Fi
- transmission frequency: 2.4 GHz WIFI
- voice communication: two-way
- motion tracking
- motorised rotation
- motion detection angle: 100°
- motion detection range: 10 meters
- human body recognition



H4052 1/-/-6
30 24 040 520 IP-500 GUARD



www.emos.eu

Order Code
Item Number

Packaging
Type

- automatic image saving
- setting the detection area
- night vision
- camera viewing angle: 100°
- IP rating: IP20
- camera resolution: 2 304 × 1 296
- motion detection
- sound detection
- compatibility: EMOS GoSmart, TUYA, LIDL, Smartlife
- protocol: Wi-Fi
- transmission frequency: 2.4 GHz WIFI
- voice communication: two-way
- motion tracking
- motorised rotation
- motion detection angle: 100°
- motion detection range: 10 meters



H4061 1/-/-12
30 24 040 610 IP-110 CUBEV2

Outdoor IP cameras



- Surveillance of exteriors of commercial and private buildings
- Alerts of unusual activity sent to mobile devices
- High weather resistance - IP65
- Two-way voice communication to deter intruders
- Automatic video and audio recording when motion is detected
- Connection to home network via WIFI protocol
- Compatible with EMOS GoSmart products and TUYA devices
- Voice control with Google Assistant and Amazon Alexa



- automatic image saving
- night vision
- camera viewing angle: 110°
- IP rating: IP55
- camera resolution: 1 920 × 1 080
- motion detection
- compatibility: EMOS GoSmart, TUYA, LIDL, Smartlife
- protocol: Wi-Fi
- transmission frequency: 2.4 GHz WIFI
- voice communication: two-way
- motion detection angle: 120°
- motion detection range: 10 meters
- human body recognition



H4056 1/-/-5
30 24 040 560 IP-600 EYE

- automatic image saving
- setting the detection area
- night vision
- camera viewing angle: 110°
- IP rating: IP65
- camera resolution: 2 616 × 1 958
- motion detection
- sound detection
- compatibility: EMOS GoSmart, TUYA, LIDL, Smartlife
- protocol: Wi-Fi
- transmission frequency: 2.4 GHz WIFI
- voice communication: two-way
- motion tracking
- motorised rotation
- motion detection angle: 110°
- motion detection range: 10 meters
- human body recognition



H4057 1/-/-4
30 24 040 570 IP-800 WASP

- automatic image saving
- setting the detection area
- night vision: yes, 4× IR LED + white LED
- camera viewing angle: 105°
- IP rating: IP65
- camera resolution: 2 048 × 1 536
- motion detection
- compatibility: EMOS GoSmart, TUYA, LIDL, Smartlife
- protocol: 4G, LTE
- transmission frequency: LTE
- voice communication: two-way
- motorised rotation
- motion detection angle: 120°
- motion detection range: 10 meters
- human body recognition



H4058 1/-/-4
30 24 040 580 IP-6000 OWL



www.emos.eu

Order Code
Item Number

Packaging
Type

- automatic image saving
- setting the detection area
- night vision: yes, 9× IR LED 850 nm
- camera viewing angle: 130°
- IP rating: IP65
- camera resolution: 2 592 × 1 944
- motion detection
- compatibility: EMOS GoSmart, TUYA, LIDL, Smartlife
- protocol: Wi-Fi

- transmission frequency: 2.4 GHz WIFI
- voice communication: two-way
- motion detection angle: 120°
- motion detection range: 9 metres
- human body recognition



H4063 1/-/-14
30 24 040 630 IP-210 SNAPV2

- automatic image saving
- setting the detection area
- night vision: yes, 4× IR LED + white LED
- camera viewing angle: 130°
- IP rating: IP65
- camera resolution: 2 304 × 1 296
- motion detection
- compatibility: EMOS GoSmart, TUYA, LIDL, Smartlife
- protocol: Wi-Fi

- transmission frequency: 2.4 GHz WIFI
- voice communication: two-way
- motion tracking
- motorised rotation
- motion detection angle: 120°
- motion detection range: 10 meters



H4064 1/-/-4
30 24 040 640 IP-310 TORCHV2
WHITE

- automatic image saving
- setting the detection area
- night vision: yes, 4× IR LED + white LED
- camera viewing angle: 130°
- IP rating: IP65
- camera resolution: 2 304 × 1 296
- motion detection
- compatibility: EMOS GoSmart, TUYA, LIDL, Smartlife
- protocol: Wi-Fi

- transmission frequency: 2.4 GHz WIFI
- voice communication: two-way
- motion tracking
- motorised rotation
- motion detection angle: 120°
- motion detection range: 10 meters



H4065 1/-/-4
30 24 040 650 IP-310 TORCHV2
BLACK

Video door phones



- Perfect access control for commercial and private properties
- Unusual activity alerts sent to mobile devices
- Two-way communication with the visitor without opening the door
- Automatic video and audio recording when motion is detected
- Night vision for perfect images in all lighting conditions
- With accessories, the ability to secure multiple homes at once
- Compatible with EMOS GoSmart products and TUYA devices

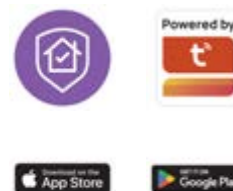

- product: doorphone set with WiFi
- screen size: 7"
- possibility to record
- lock control
- gate control
- intercom
- power supply for the screen: 12 V DC (included)
- optional connection of CCTV camera
- monitor size: 175 × 118 × 25 mm

- dimensions of the camera unit: 142 × 44 × 21 mm
- camera viewing angle: 160°
- packaging: 1 pc, box
- supported OS: Android, iOS
- compatibility: EMOS GoSmart, TUYA, LIDL, Smartlife,
- protocol: Wi-fi
- connectivity: 2.4 GHz WIFI
- voice communication: two-way



H4020 1/-/-4
30 10 040 200 IP-750A



www.emos.eu

Order Code
Item Number

Packaging
Type

- product: video phone
- screen size: 7
- lock and gate control
- intercom
- power supply for the monitor: 12 V DC (included)
- recommended camera unit: H3016, H3017, H3018,
- monitor size: 145 × 205 × 12 mm
- packaging: 1 pc, box



H4021 1/-/-6
30 10 040 210 IP-750B

Video doorbells



- Perfect access control for commercial and private properties
- Unusual activity alerts sent to mobile devices
- Two-way communication with the visitor without opening the door
- Automatic video and audio recording when motion is detected
- Night vision for perfect images in all lighting conditions
- Different power supply options for rooms w/o cable distribution
- Compatibility with EMOS GoSmart products and TUYA devices
- Voice control with Google Assistant and Amazon Alexa



- lock control
- additional indoor bell
- camera viewing angle: 110°
- camera resolution: 1 920 × 1 080
- motion detection
- IR CUT
- siren
- supported OS: Android, iOS
- compatibility: EMOS GoSmart, TUYA, LIDL, Smartlife

- protocol: Wi-Fi
- transmission frequency: 2.4 GHz WIFI
- SD card storage
- cloud storage
- anti-theft protection
- control by voice assistants
- voice communication: two-way
- notifications to the mobile app
- WebRTC function



H4030 1/-/-8
30 10 040 300 IP-09D DC

- lock control
- additional indoor bell
- camera viewing angle: 110°
- camera resolution: 1 920 × 1 080
- motion detection
- IR CUT
- siren
- supported OS: Android, iOS
- compatibility: EMOS GoSmart, TUYA, LIDL, Smartlife

- protocol: Wi-Fi
- transmission frequency: 2.4 GHz WIFI
- SD card storage
- cloud storage
- anti-theft protection
- control by voice assistants
- voice communication: two-way
- notifications to the mobile app
- WebRTC function



H4031 1/-/-12
30 10 040 310 IP-09C

- additional indoor bell
- camera viewing angle: 130°
- camera resolution: 1 920 × 1 080
- motion detection
- IR CUT
- supported OS: Android, iOS
- compatibility: EMOS GoSmart, TUYA, LIDL, Smartlife
- protocol: Wi-Fi
- transmission frequency: 2.4 GHz WIFI

- SD card storage
- cloud storage
- anti-theft protection
- control by voice assistants
- voice communication: two-way
- notifications to the mobile app
- WebRTC function



H4032 1/-/-10
30 10 040 320 IP-15S

Entry code keypads



- High quality and robust keyboard finish that prevents intentional damage and ensures long life.
- Remote unlocking via APP
- Input logging function for easy attendance management
- Individual member management (each member can have their own unique code or RFID chip)
- Compatibility with EMOS GoSmart products and TUYA devices
- Voice control with Google Assistant and Amazon Alexa

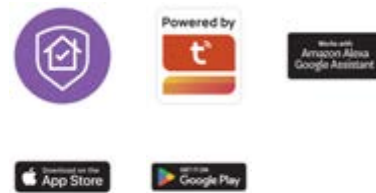

- product: keyboard RFID, TUYA
- number of switching relays: 1
- number of codes: up to 1 000
- power source: 12 V AC/DC (not included)
- dimensions: 23 × 78 × 115 mm
- packaging: 1 pc, box
- frequency: 125 kHz
- supported OS: Android, iOS
- compatibility: EMOS GoSmart, TUYA, LIDL, Smartlife
- protocol: Wi-Fi
- transmission frequency: 2.4 GHz Wi-Fi
- cloud storage



H5023 1/-/-18
 30 69 050 230 IP-006AX

Sensors



- Sensors to secure your home
- Immediate notification of an unusual situation via the app
- Optical and audible signalling
- Sensors that detect motion, water/gas leaks, fire, etc.
- Connect to your home network via Wi-Fi/ZigBee protocol
- Compatibility with EMOS GoSmart products and TUYA devices
- Voice control with Google Assistant and Amazon Alexa

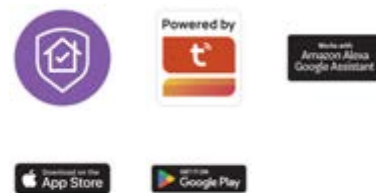

- detection type: smoke detector
- type of installation: possible to mount on the wall
- type of signaling: optical and audible
- transmission frequency: 2.4 GHz Wi-Fi
- operating temperature: 0 °C to 40 °C
- operating humidity: 0-93 %
- lifetime: 10 years
- IP rating: IP20
- power source: 2× 1.5 V AA, included
- packaging: 1 pc, small box
- supported OS: Android, iOS
- compatibility: EMOS GoSmart, TUYA, LIDL, Smartlife,
- protocol: Wi-Fi
- notifications to the mobile app
- application languages: EN, CZ, SK, PL, DE, HU, SI, FR,



P56500S 1/-/-16
 21 04 103 000 P56500S

- detection type: water leak detector
- type of installation: free-standing
- type of signaling: optical and audible
- memory of alarms
- transmission frequency: Zigbee 3.0
- operating temperature: 5 °C to 38 °C
- operating humidity: ≤80 % without condensation
- lifetime: 10 years
- IP rating: IP65
- power source: 1× 3 V CR2, included
- packaging: 1 pc, small box
- supported OS: Android, iOS
- compatibility: EMOS GoSmart, TUYA, LIDL, Smartlife,
- protocol: Zigbee 3.0
- notifications to the mobile app
- application languages: EN, CZ, SK, PL, DE, HU, SI, FR,



P56000S 1/-/-48
 21 04 104 000 P56000S



www.emos.eu

Order Code
Item Number

Packaging
Type

- detection type: detector CO
- type of installation: possible to mount on the wall or ceiling
- type of signaling: optical and audible
- memory of alarms
- transmission frequency: 2.4 GHz Wi-Fi
- operating temperature: -10 °C to 40 °C
- operating humidity: 15–93 %
- lifetime: 10 years
- IP rating: IP30
- power source: 2× 1.5 V AA, included
- packaging: 1 pc, small box
- supported OS: Android, iOS
- compatibility: EMOS GoSmart, TUYA, LIDL, Smartlife,
- protocol: Wi-Fi
- notifications to the mobile app
- application languages: EN, CZ, SK, PL, DE, HU, SI, FR,



P56400S

1/-/-/20

21 04 105 000

TCS0101W

- product: motion sensor
- detection angle: 90°
- detection distance: 8 m
- IP rating: IP20
- sensor type: PIR
- power source: 1× CR123A (3 V)
- packaging: 1 pc, small box
- supported OS: Android, iOS
- compatibility: EMOS GoSmart, TUYA, LIDL, Smartlife
- protocol: Zigbee 3.0
- transmission frequency: 2.4 GHz (2 405–2 480 MHz)
- notifications to the mobile app
- application languages: EN, CZ, SK, PL, DE, HU, SI, FR,



H5020

1/-/-/40

30 69 052 010

IP-2210Z

- product: door/window sensor
- IP rating: IP20
- sensor type: magnetic
- power source: 1× CR2032 (3 V)
- packaging: 1 pc, small box
- supported OS: Android, iOS
- compatibility: EMOS GoSmart, TUYA, LIDL, Smartlife
- protocol: Zigbee 3.0
- transmission frequency: 2.4 GHz (2 405–2 480 MHz)
- notifications to the mobile app
- application languages: EN, CZ, SK, PL, DE, HU, SI, FR,



H5021

1/-/-/100

30 69 052 020

IP-2211Z

Luminaires and Light Sources

Bulbs



- Remote light on/off
- Brightness, light colour and chromaticity temperature control
- Energy saving with automatic switch-off and dimming options
- Set unique lighting scenes for different activities
- Easy to install and create automations
- Connection to the home network via WIFI protocol
- Compatibility with EMOS GoSmart products and TUYA devices
- Voice control with Google Assistant and Amazon Alexa



- replacement of incandescent bulb: 60 W
- dimmable
- shape: A60
- luminous flux: 806 lm
- color temperature: 2 700-6 500 K
- power: 9 W
- luminous efficacy: 90 lm/W
- energy efficiency class: F
- beam angle: 200°

- color rendering index (CRI): Ra >80
- voltage: 230 V~/50 Hz
- dimensions: 60 × 60 × 120 mm
- packaging: 1 pc, small box
- supported OS: Android, iOS
- compatibility: EMOS GoSmart, TUYA, LIDL, Smartlife
- protocol: Wi-Fi
- control by voice assistants
- notifications to the mobile app



ZQW514R 1/-/10/40
15 20 503 500 ZQW514R

- replacement of incandescent bulb: 75 W
- dimmable
- shape: A60
- luminous flux: 1 050 lm
- color temperature: 2 700-6 500 K
- power: 11 W
- luminous efficacy: 95 lm/W
- energy efficiency class: F
- beam angle: 200°

- color rendering index (CRI): Ra >80
- voltage: 230 V~/50 Hz
- dimensions: 60 × 60 × 125 mm
- packaging: 1 pc, small box
- supported OS: Android, iOS
- compatibility: EMOS GoSmart, TUYA, LIDL, Smartlife
- protocol: Wi-Fi
- control by voice assistants
- notifications to the mobile app

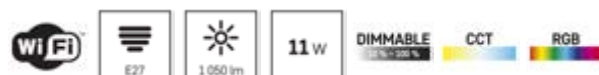

ZQW515R 1/-/10/40
15 20 503 501 ZQW515R

- replacement of incandescent bulb: 94 W
- dimmable
- shape: A65
- luminous flux: 1 400 lm
- color temperature: 2 700-6 500 K
- power: 14 W
- luminous efficacy: 100 lm/W
- energy efficiency class: F
- beam angle: 200°

- color rendering index (CRI): Ra >80
- voltage: 230 V~/50 Hz
- dimensions: 65 × 65 × 134 mm
- packaging: 1 pc, small box
- supported OS: Android, iOS
- compatibility: EMOS GoSmart, TUYA, LIDL, Smartlife
- protocol: Wi-Fi
- control by voice assistants
- notifications to the mobile app



ZQW516R 1/-/4/24
15 20 503 502 ZQW516R



www.emos.eu

Order Code
Item Number

Packaging
Type

- replacement of incandescent bulb: 40 W
- dimmable
- shape: Candle
- luminous flux: 470 lm
- color temperature: 2 700–6 500 K
- power: 4.8 W
- luminous efficacy: 98 lm/W
- energy efficiency class: F
- beam angle: 180°

- color rendering index (CRI): Ra >80
- voltage: 230 V~/50 Hz
- dimensions: 37 × 37 × 110 mm
- packaging: 1 pc, small box
- supported OS: Android, iOS
- compatibility: EMOS GoSmart, TUYA, LIDL, Smartlife
- protocol: Wi-Fi
- control by voice assistants
- notifications to the mobile app

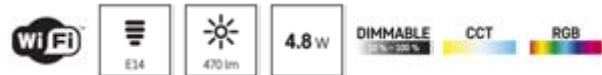

ZQW322R 1/-/10/60
15 25 501 500 ZQW322R

- replacement of incandescent bulb: 35 W
- dimmable
- shape: MR16
- luminous flux: 400 lm
- color temperature: 2 700–6 500 K
- power: 4.8 W
- luminous efficacy: 83 lm/W
- energy efficiency class: G
- beam angle: 120°

- color rendering index (CRI): Ra >80
- voltage: 230 V~/50 Hz
- dimensions: 50 × 50 × 56.5 mm
- packaging: 1 pc, small box
- supported OS: Android, iOS
- compatibility: EMOS GoSmart, TUYA, LIDL, Smartlife
- protocol: Wi-Fi
- control by voice assistants
- notifications to the mobile app



ZQW832R 1/-/4/72
15 25 500 500 ZQW832R

- replacement of incandescent bulb: 60 W
- dimmable
- shape: A60
- luminous flux: 806 lm
- color temperature: 2 700–6 500 K
- power: 9 W
- luminous efficacy: 90 lm/W
- energy efficiency class: F
- beam angle: 200°

- color rendering index (CRI): Ra >80
- voltage: 230 V~/50 Hz
- dimensions: 60 × 60 × 120 mm
- packaging: 1 pc, small box
- supported OS: Android, iOS
- compatibility: EMOS GoSmart, TUYA, LIDL, Smartlife
- protocol: Zigbee 3.0
- control by voice assistants
- notifications to the mobile app



ZQZ514R 1/-/10/40
15 25 753 500 ZQZ514R

- replacement of incandescent bulb: 75 W
- dimmable
- shape: A60
- luminous flux: 1 050 lm
- color temperature: 2 700–6 500 K
- power: 11 W
- luminous efficacy: 95 lm/W
- energy efficiency class: F
- beam angle: 200°

- color rendering index (CRI): Ra >80
- voltage: 230 V~/50 Hz
- dimensions: 60 × 60 × 125 mm
- packaging: 1 pc, small box
- supported OS: Android, iOS
- compatibility: EMOS GoSmart, TUYA, LIDL, Smartlife
- protocol: Zigbee 3.0
- control by voice assistants
- notifications to the mobile app

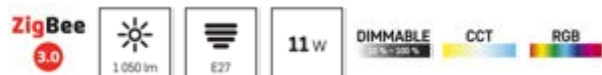

ZQZ515R 1/-/10/40
15 25 753 501 ZQZ515R

- replacement of incandescent bulb: 94 W
- dimmable
- shape: A65
- luminous flux: 1 400 lm
- color temperature: 2 700–6 500 K
- power: 14 W
- luminous efficacy: 100 lm/W
- energy efficiency class: F
- beam angle: 200°

- color rendering index (CRI): Ra >80
- voltage: 230 V~/50 Hz
- dimensions: 65 × 65 × 134 mm
- packaging: 1 pc, small box
- supported OS: Android, iOS
- compatibility: EMOS GoSmart, TUYA, LIDL, Smartlife
- protocol: Zigbee 3.0
- control by voice assistants
- notifications to the mobile app



ZQZ516R 1/-/10/40
15 25 753 502 ZQZ516R



www.emos.eu

Order Code
Item Number

Packaging
Type

- replacement of incandescent bulb: 40 W
- dimmable
- shape: Candle
- luminous flux: 470 lm
- color temperature: 2 700–6 500 K
- power: 4.8 W
- luminous efficacy: 98 lm/W
- energy efficiency class: F
- beam angle: 180°
- color rendering index (CRI): Ra >80
- voltage: 230 V~/50 Hz
- dimensions: 37 × 37 × 110 mm
- packaging: 1 pc, small box
- supported OS: Android, iOS
- compatibility: EMOS GoSmart, TUYA, LIDL, Smartlife
- protocol: Zigbee 3.0
- control by voice assistants
- notifications to the mobile app



ZQZ322R 1/-/10/60
15 25 751 500 ZQZ322R

- replacement of incandescent bulb: 35 W
- dimmable
- shape: MR16
- luminous flux: 400 lm
- color temperature: 2 700–6 500 K
- power: 4.8 W
- luminous efficacy: 83 lm/W
- energy efficiency class: G
- beam angle: 120°
- color rendering index (CRI): Ra >80
- voltage: 230 V~/50 Hz
- dimensions: 50 × 50 × 56.5 mm
- packaging: 1 pc, small box
- supported OS: Android, iOS
- compatibility: EMOS GoSmart, TUYA, LIDL, Smartlife
- protocol: Zigbee 3.0
- control by voice assistants
- notifications to the mobile app

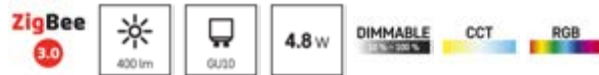

ZQZ832R 1/-/4/72
15 25 750 500 ZQZ832R

Luminaires



- Control via remote control or mobile app
- Adjustment of light intensity and colour
- Timer and night light function
- Connection to the home network via WIFI protocol
- Compatibility with EMOS GoSmart products and TUYA devices
- Voice control with Google Assistant and Amazon Alexa

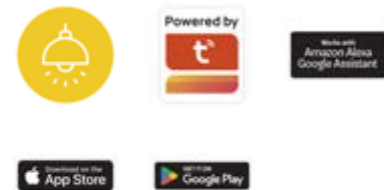

- power: 30 W
- replacement of incandescent bulb: 110 W
- luminous flux: 1 800 lm
- color temperature: 2 700–6 500 K
- body material: steel plate
- color rendering index (CRI): Ra > 80
- beam angle: 115°
- type of mounting: surface
- dimensions: 400 × 70 mm in diameter
- dimming function
- body colour: white
- line: GoSmart
- warranty period: 3 years
- supported OS: Android, iOS
- compatibility: EMOS GoSmart, TUYA, LIDL, Smartlife
- protocol: Wi-Fi
- transmission frequency: 2.4 GHz Wi-Fi
- control by voice assistants



ZM5191 1/-/-/5
15 39 087 300 ZM5191

- power: 45 W
- replacement of incandescent bulb: 160 W
- luminous flux: 2 700 lm
- color temperature: 2 700–6 500 K
- body material: steel plate
- color rendering index (CRI): Ra > 80
- beam angle: 115°
- type of mounting: surface
- dimensions: 500 × 70 mm in diameter
- dimming function
- body colour: white
- line: GoSmart
- warranty period: 3 years
- supported OS: Android, iOS
- compatibility: EMOS GoSmart, TUYA, LIDL, Smartlife
- protocol: Wi-Fi
- transmission frequency: 2.4 GHz Wi-Fi
- control by voice assistants



ZM5192 1/-/-/5
15 39 087 400 ZM5192

Christmas Lighting



- 64 lighting modes for a festive atmosphere
- Timer function for scheduled on/off
- Music synchronization for rhythmic blinking
- Various lengths 8–24 m, suitable for both indoor and outdoor use
- Connection to the home network via WIFI protocol
- Compatibility with EMOS GoSmart products and TUYA devices
- Voice control with Google Assistant and Amazon Alexa



- product: chain
- light color: RGB
- dimensions: 8 m
- area of use: both outdoor and indoor
- timer
- remote control: no
- number of LED: 80
- supply line length: 5 m
- power: 8.4 W

- IP rating: IP44
- lifetime: 10 000 hours
- supported OS: Android, iOS
- compatibility: EMOS GoSmart, TUYA, LIDL, Smartlife,
- protocol: Wi-Fi
- transmission frequency: 2,4 GHz Wi-Fi
- control by voice assistants
- notifications to the mobile app
- application languages: EN, CZ, SK, PL, DE, HU, SI, FR,



D4ZR01 1/-/-/30
15 50 044 028 D4ZR01

- product: chain
- light color: RGB
- dimensions: 12 m
- area of use: both outdoor and indoor
- timer
- remote control: no
- number of LED: 120
- supply line length: 5 m
- power: 8.4 W

- IP rating: IP44
- lifetime: 10 000 hours
- supported OS: Android, iOS
- compatibility: EMOS GoSmart, TUYA, LIDL, Smartlife,
- protocol: Wi-Fi
- transmission frequency: 2,4 GHz Wi-Fi
- control by voice assistants
- notifications to the mobile app
- application languages: EN, CZ, SK, PL, DE, HU, SI, FR,



D4ZR02 1/-/-/25
15 50 044 029 D4ZR02

- product: chain
- light color: RGB
- dimensions: 18 m
- area of use: both outdoor and indoor
- timer
- remote control: no
- number of LED: 180
- supply line length: 5 m
- power: 8.4 W

- IP rating: IP44
- lifetime: 10 000 hours
- supported OS: Android, iOS
- compatibility: EMOS GoSmart, TUYA, LIDL, Smartlife,
- protocol: Wi-Fi
- transmission frequency: 2,4 GHz Wi-Fi
- control by voice assistants
- notifications to the mobile app
- application languages: EN, CZ, SK, PL, DE, HU, SI, FR,



D4ZR03 1/-/-/20
15 50 044 030 D4ZR03

- product: chain
- light color: RGB
- dimensions: 24 m
- area of use: both outdoor and indoor
- timer
- remote control: no
- number of LED: 240
- supply line length: 5 m
- power: 8.4 W

- IP rating: IP44
- lifetime: 10 000 hours
- supported OS: Android, iOS
- compatibility: EMOS GoSmart, TUYA, LIDL, Smartlife,
- protocol: Wi-Fi
- transmission frequency: 2,4 GHz Wi-Fi
- control by voice assistants
- notifications to the mobile app
- application languages: EN, CZ, SK, PL, DE, HU, SI, FR,



D4ZR04 1/-/-/16
15 50 044 031 D4ZR04

Wiring and Control

Scenic switches



- Control multiple electrical devices or lights at once
- Define trigger events for individual buttons
- Long power supply battery life - up to 2 years
- Installation without pulling electrical cables
- Three-position buttons - press, double press, long press
- Communication via Zigbee protocol
- Compatible with EMOS GoSmart products and TUYA devices
- Voice control with Google Assistant and Amazon Alexa

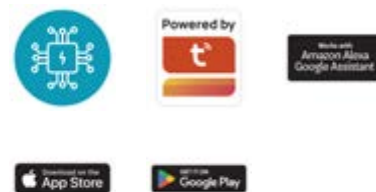

- product: IP Smart Scene Switcher
- connectivity: ZigBee 2.4 GHz
- compatibility: EMOS GoSmart, TUYA, LIDL, Smartlife
- protocol: Zigbee 3.0
- pairing: automatic, manual
- use: automation
- number of control buttons: 1
- power supply: CR 2430 3 V
- supported OS: Android, iOS



8 592920 121221 **H5011** 1/-/-/60
30 69 050 110 IP-2001ZW

- product: IP Smart Scene Switcher
- connectivity: ZigBee 2.4 GHz
- compatibility: EMOS GoSmart, TUYA, LIDL, Smartlife
- protocol: Zigbee 3.0
- pairing: automatic, manual
- use: automation
- number of control buttons: 2
- power supply: CR 2430 3 V
- supported OS: Android, iOS



8 592920 121474 **H5012** 1/-/-/60
30 69 050 120 IP-2002ZW

- product: IP Smart Scene Switcher
- connectivity: ZigBee 2.4 GHz
- compatibility: EMOS GoSmart, TUYA, LIDL, Smartlife
- protocol: Zigbee 3.0
- pairing: automatic, manual
- use: automation
- number of control buttons: 4
- power supply: CR 2430 3 V
- supported OS: Android, iOS



8 592920 121498 **H5013** 1/-/-/60
30 69 050 130 IP-2004ZW



- product: IP Smart Scene Switcher
- connectivity: ZigBee 2.4 GHz
- compatibility: EMOS GoSmart, TUYA, LIDL, Smartlife
- protocol: Zigbee 3.0
- pairing: automatic, manual
- use: automation
- number of control buttons: 1
- power supply: CR 2430 3 V
- supported OS: Android, iOS



H5014 1/-/-/60
30 69 050 140 IP-2001ZB

- product: IP Smart Scene Switcher
- connectivity: ZigBee 2.4 GHz
- compatibility: EMOS GoSmart, TUYA, LIDL, Smartlife
- protocol: Zigbee 3.0
- pairing: automatic, manual
- use: automation
- number of control buttons: 2
- power supply: CR 2430 3 V
- supported OS: Android, iOS



H5015 1/-/-/60
30 69 050 150 IP-2002ZB

- product: IP Smart Scene Switcher
- connectivity: ZigBee 2.4 GHz
- compatibility: EMOS GoSmart, TUYA, LIDL, Smartlife
- protocol: Zigbee 3.0
- pairing: automatic, manual
- use: automation
- number of control buttons: 4
- power supply: CR 2430 3 V
- supported OS: Android, iOS



H5016 1/-/-/60
30 69 050 160 IP-2004ZB

Zigbee gateways

- To expand the smart home with additional sensors and products
- Allows automation settings for added sensors and products
- Communication protocols Wi-Fi/Zigbee 3.0/BLE/SigMesh
- Compatibility with EMOS GoSmart products and TUYA devices



- product: IP gateway
- connectivity: 2.4 GHz WIFI
- maximum number of connected clients: 50
- compatibility: EMOS GoSmart, TUYA, LIDL, Smartlife
- protocol: Wi-Fi/Zigbee 3.0/BLE/SigMesh
- pairing: automatic, manual
- use: automation
- number of control buttons: 1
- power supply: 5 V DC/1.0 A
- supported OS: Android, iOS



H5001 1/-/-/120
30 69 050 010 IP-1000Z



- product: ZigBee repeater
- connectivity: 2.4 GHz WIFI
- compatibility: EMOS GoSmart, TUYA, LIDL, Smartlife
- protocol: Zigbee 3.0
- pairing: automatic, manual
- use: automation
- power supply: 5 V DC/1.0 A
- supported OS: Android, iOS



H5022
30 69 052 030

1/-/-/60
IP-2213Z

Sockets



- Remote on/off switching of connected appliances
- Overview of electricity consumption of connected appliances
- Schedule creation and automatic ON/OFF settings
- Setting up delayed shutdown of appliances
- Network connection via WIFI or Bluetooth protocols
- Compatibility with EMOS GoSmart products and TUYA devices
- Voice control with Google Assistant and Amazon Alexa

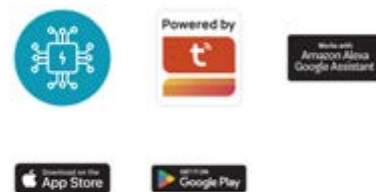

- product: Wi-Fi socket
- maximum load: 3 680 W
- voltage/current: 230 V~/16 A max.
- transmission frequency: 2.4 GHz WIFI
- children protection
- supported OS: Android, iOS
- compatibility: EMOS GoSmart, TUYA, LIDL, Smartlife
- protocol: Wi-Fi
- control by voice assistants
- notifications to the mobile app



P5531
19 36 055 310

1/-/-/32
IP-3002S

- product: Wi-Fi timer/wattmeter-outside
- maximum load: 3 680 W
- voltage/current: 230 V~/16 A max.
- transmission frequency: 2,4 GHz
- children protection
- supported OS: Android, iOS
- compatibility: EMOS GoSmart, TUYA, LIDL, Smartlife
- protocol: Wi-Fi
- control by voice assistants
- notifications to the mobile app



P5532
19 36 055 320

1/-/-/30
IP-3006S

- product: ZigBee socket
- maximum load: 3 680 W
- voltage/current: 230 V~/16 A max.
- transmission frequency: 2,4 GHz
- children protection
- supported OS: Android, iOS
- compatibility: EMOS GoSmart, TUYA, LIDL, Smartlife
- protocol: Zigbee 3.0
- control by voice assistants
- notifications to the mobile app



P5533
19 36 553 300

1/-/-/32
IP-3009S



- product: ZigBee socket
 - maximum load: 3 680 W
 - voltage/current: 230 V~/16 A max.
 - transmission frequency: 2,4 GHz
 - children protection
 - supported OS: Android, iOS
 - compatibility: EMOS GoSmart, TUYA, LIDL, Smartlife
 - protocol: Zigbee 3.0
 - control by voice assistants
- notifications to the mobile app



P5534
19 36 553 400

1/-/-/30
IP-3010S

Modules



- Remote control of connected devices
- Integration into home automation
- Variants for connection with or without the need for a neutral wire
- Easy installation under original switches
- Connection to the home network via WIFI/ZigBee protocol
- Compatibility with EMOS GoSmart products and TUYA devices
- Voice control with Google Assistant and Amazon Alexa

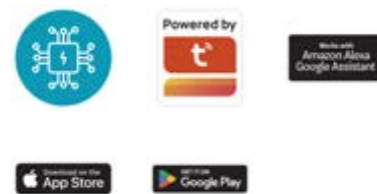

- product: IP switching module
 - connectivity: ZigBee 2.4 GHz
 - compatibility: EMOS GoSmart, TUYA, LIDL, Smartlife
 - control by voice assistants
 - protocol: Zigbee 3.0
 - pairing: automatic, manual
 - use: indoor
 - number of control buttons: 1
 - power supply: 230 V~/50 Hz, max. 0,3 W
- supported OS: Android, iOS



H5101
30 69 051 010

1/-/-/100
IP-2101SZ

- product: IP switching module
 - connectivity: ZigBee 2.4 GHz
 - compatibility: EMOS GoSmart, TUYA, LIDL, Smartlife
 - control by voice assistants
 - protocol: Zigbee 3.0
 - pairing: automatic, manual
 - use: indoor
 - number of control buttons: 1
 - power supply: 230 V~/50 Hz, max. 0,3 W
- supported OS: Android, iOS



H5102
30 69 051 020

1/-/-/100
IP-2102SZ

- product: IP switching module
 - connectivity: ZigBee 2.4 GHz
 - compatibility: EMOS GoSmart, TUYA, LIDL, Smartlife
 - control by voice assistants
 - protocol: Zigbee 3.0
 - pairing: automatic, manual
 - use: indoor
 - number of control buttons: 1
 - power supply: 230 V~/50 Hz, max. 0,3 W
- supported OS: Android, iOS



H5103
30 69 051 030

1/-/-/100
IP-2103SZ



- product: IP switching module
 - connectivity: ZigBee 2.4 GHz
 - compatibility: EMOS GoSmart, TUYA, LIDL, Smartlife
 - control by voice assistants
 - protocol: Zigbee 3.0
 - pairing: automatic, manual
 - use: indoor
 - number of control buttons: 1
 - power supply: 230 V~/50 Hz, max. 0,3 W
- = supported OS: Android, iOS



H5104
30 69 051 040

1/-/-/100
IP-2104SZ



- product: IP switching module
 - connectivity: 2.4 GHz WIFI
 - compatibility: EMOS GoSmart, TUYA, LIDL, Smartlife
 - control by voice assistants
 - protocol: Wi-Fi
 - pairing: automatic, manual
 - use: indoor
 - number of control buttons: 1
 - power supply: 230 V~/50 Hz, max. 0,3 W
- = supported OS: Android, iOS



H5105
30 69 051 050

1/-/-/100
IP-2101SW



- product: IP switching module
 - connectivity: 2.4 GHz WIFI
 - compatibility: EMOS GoSmart, TUYA, LIDL, Smartlife
 - control by voice assistants
 - protocol: Wi-Fi
 - pairing: automatic, manual
 - use: indoor
 - number of control buttons: 1
 - power supply: 230 V~/50 Hz, max. 0,3 W
- = supported OS: Android, iOS



H5106
30 69 051 060

1/-/-/100
IP-2102SW



- product: IP dimming module
 - connectivity: ZigBee 2.4 GHz
 - compatibility: EMOS GoSmart, TUYA, LIDL, Smartlife
 - control by voice assistants
 - protocol: Zigbee 3.0
 - pairing: automatic, manual
 - use: indoor
 - number of control buttons: 1
 - power supply: 230 V~/50 Hz, max. 0,3 W
- = supported OS: Android, iOS



H5107
30 69 051 070

1/-/-/100
IP-2111DZ



- product: IP dimming module
 - connectivity: ZigBee 2.4 GHz
 - compatibility: EMOS GoSmart, TUYA, LIDL, Smartlife
 - control by voice assistants
 - protocol: Zigbee 3.0
 - pairing: automatic, manual
 - use: indoor
 - number of control buttons: 1
 - power supply: 230 V~/50 Hz, max. 0,3 W
- = supported OS: Android, iOS



H5108
30 69 051 080

1/-/-/100
IP-2112DZ





- product: IP motor module
 - connectivity: ZigBee 2.4 GHz
 - compatibility: EMOS GoSmart, TUYA, LIDL, Smartlife
 - control by voice assistants
 - protocol: Zigbee 3.0
 - pairing: automatic, manual
 - use: indoor
 - number of control buttons: 1
 - power supply: 230 V~/50 Hz, max. 0,3 W
- supported OS: Android, iOS



H5109	1/-/-/100
30 69 051 090	IP-2121CZ

- product: IP motor module
 - connectivity: ZigBee 2.4 GHz
 - compatibility: EMOS GoSmart, TUYA, LIDL, Smartlife
 - control by voice assistants
 - protocol: Zigbee 3.0
 - pairing: automatic, manual
 - use: indoor
 - number of control buttons: 1
 - power supply: 230 V~/50 Hz, max. 0,3 W
- supported OS: Android, iOS



H5110	1/-/-/100
30 69 051 100	IP-2122CZ

- product: IP motor module
 - connectivity: 2.4 GHz WIFI
 - compatibility: EMOS GoSmart, TUYA, LIDL, Smartlife
 - control by voice assistants
 - protocol: Wi-Fi/BLE
 - pairing: automatic, manual
 - use: indoor
 - number of control buttons: 1
 - power supply: 230 V~/50 Hz, max. 0,3 W
- supported OS: Android, iOS



H5111	1/-/-/32
30 69 051 110	IP-2131SW

Measurement and Control

Thermostats



- Reduce heating/cooling costs for buildings
- Individual temperature settings for different rooms
- Set temperature scenarios for specific day and time
- Control all settings from anywhere using the app
- Heating or air conditioning control based on GPS location
- Connection via WIFI or Zigbee protocols
- Compatibility with EMOS GoSmart products and TUYA devices
- Voice control with Google Assistant and Amazon Alexa

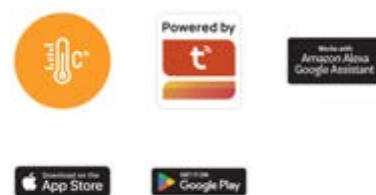

thermostat type: wire = type of control: programmable electronic room thermostat, option to control via mobile phone (iOS, Android) = backlight display = control mode: heating and cooling system = number of programs: customisable temperature (6× per day) = temperature adjustment type: 6 temperature changes per day = temperature measurement: 0 °C to 40 °C, resolution 0.1 °C = temperature adjustment: from 5 °C up to 35 °C, after 0.5 °C = anti-frost protection = ON/OFF function = holiday mode = switching: voltage 230 V AC, 50 Hz = switching load: 6 A resistive, 2 A inductive = power source: 230 V AC = dimensions: 138 × 88 × 33 mm



P56201 1/-/-12
21 01 900 000 P56201

thermostat type: wireless = type of control: programmable electronic room thermostat, option to control via mobile phone (iOS, Android) = backlight display = control mode: heating and cooling system = number of programs: customisable temperature (6× per day) = temperature adjustment type: 6 temperature changes per day = temperature measurement: 0 °C to 40 °C, resolution 0.1 °C = temperature adjustment: from 5 °C up to 35 °C, after 0.5 °C = anti-frost protection = ON/OFF function = holiday mode = switching: 230 V AC or potential-free = switching load: 16 A resistive, 4 A inductive = power of transmitter: 5 V USB adapter (included) = power of receiver: 230 V AC = receiver's dimension: 37 × 86 × 86 mm = transmitter's dimension: 40 × 138 × 96 mm



P56211 1/-/-9
21 01 900 001 P56211

thermostat type: wired for underfloor heating, concealed = type of control: programmable electronic room thermostat, option to control via mobile phone (iOS, Android) = backlight display = control mode: heating system = number of programs: customisable temperature (6× per day) = temperature adjustment type: 6 temperature changes per day = temperature measurement: 0 °C to 95 °C, resolution 0.5 °C = temperature adjustment: from 1 °C up to 70 °C, after 0.5 °C = anti-frost protection = ON/OFF function = holiday mode = switching: voltage 230 V AC, 50 Hz = switching load: 16 A resistive = power source: 230 V AC = dimensions: 86 × 86 × 43 mm = part of the package: thermostat, floor sensor 3 m, Ø 8 mm



P56201UF 1/-/-36
21 01 900 002 P56201UF

thermo shut-off valve: SMART, programmable = number of programs: 1 customisable programme or customisable temperature (6× per day) = temperature adjustment type: 6 temperature changes per day = temperature measurement: 0 °C to 70 °C, resolution 0.5 °C = temperature adjustment: 1 °C to 70 °C, resolution 0.5 °C = anti-frost protection = holiday mode = open window function = child lock = matrix: M30 × 1.5 mm = enclosed adaptors: Danfoss RA, RAV, RAVL = power source: 2× 1.5 V AA (included) = dimensions: 55 × 94 × 55 mm = packaging: 1 pc, small box



P5630S 1/-/-/24
21 01 900 003 P5630S

Weather stations and Thermometers



- For measuring indoor temperature and humidity
- Display temperature and humidity data history in the app
- Temperature and humidity alerts via alarm
- Small size and elegant design
- Battery powered
- Connection to home network via ZigBee protocol
- Compatibility with EMOS GoSmart products and TUYA devices
- Voice control with Google Assistant and Amazon Alexa



- thermometer design: wireless – smart
- indoor temperature: -20 °C to +60 °C, resolution 0.1
- indoor humidity: 0 % to 99 % RH, resolution 1 %
- temperature warning
- the possibility of hanging on the wall
- power of station: 1× 3 V CR2032 (included)
- main unit size: 26 × 13 × 52 mm



EGS0102 1/-/-/80
26 03 122 000 EGS0102

- thermometer design: wireless – smart
- clock: wifi
- LED backlight display
- date
- indoor temperature: -10 °C to +60 °C, resolution 0.1
- indoor humidity: 0 % to 99 % RH, resolution 1 %
- min. and max. temperature
- temperature warning
- the possibility of hanging on the wall
- power of station: 3× 1.5 V AAA (not included)
- main unit size: 56 × 23 × 56 mm
- screen size: 42 × 40 mm



EGS0101 1/-/-/80
26 03 123 000 EGS0101



Air quality



- Overview of the CO2 level in the monitored room
- Display of indoor temperature, humidity and hours
- LED display with permanent backlight
- Colour animation of air quality
- Built-in alarm for elevated CO2 concentration
- Connection to home network via WIFI protocol
- Compatibility with EMOS GoSmart products and TUYA devices

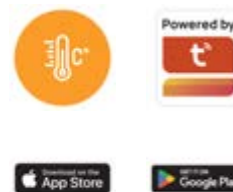

- option to set the temperature unit: °C/°F
- CO2 alert
- setting CO2 alert limits
- CO2 level indicator
- CO2 measurement range: 400 to 5 000 PPM
- indoor temperature: 0 °C to +50 °C, resolution 0.1°C
- indoor humidity: 20 % to 90 % RH, resolution 1 %
- supported OS: Android, iOS
- compatibility: EMOS GoSmart, TUYA, LIDL, Smartlife
- protocol: Wi-Fi
- transmission frequency: 2.4 GHz Wi-Fi
- notifications to the mobile app
- application languages: EN, CZ, SK, PL, DE, HU, SI, FR,



E30300 1/-/-/12
26 27 303 000 E30300

Control valves



- Manual and automatic control
- Timer function for setting a schedule
- High power and torque
- Immediate response to crash detection
- Connection to home network via ZIGBEE protocol
- Compatibility with EMOS GoSmart products and TUYA devices
- Voice control with Google Assistant and Amazon Alexa

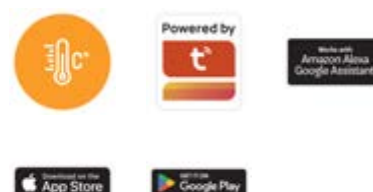

- product: valve controller
- pipe diameter: 1/2", 3/4", 1" a 1 1/4"
- torque: max. 5.88 Nm
- operating temperature: -10 °C to 55 °C
- operating humidity: <95 %
- IP rating: IP20
- power source: DC 12 V/1 000 mA, 1.4 m (included)
- supported OS: Android, iOS
- compatibility: EMOS GoSmart, TUYA, LIDL, Smartlife
- protocol: Zigbee 3.0
- transmission frequency: 2.4 GHz Wi-Fi
- notifications to the mobile app
- control by voice assistants
- application languages: EN, CZ, SK, PL, DE, HU, SI, FR,



P5640S 1/-/-/12
21 05 564 000 P5640S

Household and Garden

Bathroom Scales



- Wide range of measuring indicators
- Clear reports in graphical form
- Memory for several users
- Elegant design
- Weighing accuracy to 100 g, max. load capacity 180 kg
- Connection to home network via Bluetooth
- Compatibility with EMOS GoSmart products and TUYA devices



- backlight display
- scale surface: ITO tempered glass
- maximum load: 180 kg
- Bluetooth
- BMI – measurement of fat, water and muscle
- weight units: kg, lb
- memory: 10 persons max.
- power source: 3× 1.5 V AAA (included)
- dimensions: 26 × 300 × 300 mm
- supported OS: Android, iOS
- compatibility: EMOS GoSmart, TUYA, LIDL, Smartlife,
- protocol: Wi-Fi
- transmission frequency: 2.4 GHz Wi-Fi
- notifications to the mobile app
- application languages: EN, CZ, SK, PL, DE, HU, SI, FR,



EV112

1/-/-/3

8 592920 122129

26 17 010 902

EV112



Batteries

GP Batteries

GP Consumer batteries

GP Alkaline

GP Ultra Plus



- most powerful line of GP alkaline batteries
- for demanding devices requiring maximum performance
- up to 200 % more power than standard alkaline batteries
- long lasting performance
- operating temperature from -20 °C to +54 °C
- shelf life up to 10 years



- chemical constitution: alkaline
- type: LR03 (AAA battery)
- voltage: 1.5 V
- dimensions: 10.5 × 44.5 mm
- weight: 13 g
- operating temperature: -20 °C to +54 °C
- packaging: 2 pcs, small paper box



B03112 2/-/20/160
10 13 122 000 GP 24AUP

- chemical constitution: alkaline
- type: LR03 (AAA battery)
- voltage: 1.5 V
- dimensions: 10.5 × 44.5 mm
- weight: 13 g
- operating temperature: -20 °C to +54 °C
- packaging: 4 pcs, small paper box



B03114 4/-/40/320
10 13 124 000 GP 24AUP



www.emos.eu

Order Code
Item Number

Packaging
Type

- chemical constitution: alkaline
- type: LR03 (AAA battery)
- voltage: 1.5 V
- dimensions: 10.5 × 44.5 mm
- weight: 13 g
- operating temperature: -20 °C to +54 °C
- packaging: 10 pc, small paper box



B0314G 10/-/100/400
10 17 101 000 GPPCA24UP

- chemical constitution: alkaline
- type: LR6 (AA battery)
- voltage: 1.5 V
- dimensions: 14.5 × 50.5 mm
- weight: 24 g
- operating temperature: -20 °C to +54 °C
- packaging: 2 pcs, small paper box



B03212 2/-/20/160
10 13 222 000 GP 15AUP

- chemical constitution: alkaline
- type: LR6 (AA battery)
- voltage: 1.5 V
- dimensions: 14.5 × 50.5 mm
- weight: 24 g
- operating temperature: -20 °C to +54 °C
- packaging: 4 pcs, small paper box



B03214 4/-/40/320
10 13 224 000 GP 15AUP

- chemical constitution: alkaline
- type: LR6 (AA battery)
- voltage: 1.5 V
- dimensions: 14.5 × 50.5 mm
- weight: 28 g
- operating temperature: -20 °C to +54 °C
- packaging: 10 pc, small paper box



B0324G 10/-/100/400
10 17 201 000 GP15AUP

- chemical constitution: alkaline
- type: LR14 (C battery)
- voltage: 1.5 V
- dimensions: 26.2 × 50.0 mm
- weight: 70 g
- operating temperature: -18 °C to +50 °C
- packaging: 2 pcs, small paper box



B03312 2/-/20/160
10 13 322 000 GP 14AUP



www.emos.eu

Order Code
Item Number

Packaging
Type

- chemical constitution: alkaline
- type: LR20 (D battery)
- voltage: 1.5 V
- dimensions: 34.2 × 61.5 mm
- weight: 142 g
- operating temperature: -18 °C to +50 °C
- packaging: 2 pcs, small paper box



B03412 2/-/20/80
10 13 422 000 GP 13AUP

- chemical constitution: alkaline
- type: 6LR61 9 V
- voltage: 9 V
- dimensions: 26.5 × 17.5 × 48.5 mm
- weight: 47 g
- operating temperature: -18 °C to +50 °C
- packaging: 1 pc, small paper box



B03511 1/-/10/200
10 13 521 000 GP 1604AUP

GP Ultra



- suitable for devices with medium power consumption
- up to 80 % more power than standard alkaline batteries
- operating temperature from -20 °C to +54 °C
- shelf life up to 10 years



- chemical constitution: alkaline
- type: LR03 (AAA battery)
- voltage: 1.5 V
- dimensions: 10.5 × 44.5 mm
- weight: 11.5 g
- operating temperature: -18 °C to +50 °C
- packaging: 2 pcs, small paper box



B02112 2/-/20/160
10 14 122 000 GP 24A

- chemical constitution: alkaline
- type: LR03 (AAA battery)
- voltage: 1.5 V
- dimensions: 10.5 × 44.5 mm
- weight: 11.5 g
- operating temperature: -18 °C to +50 °C
- packaging: 4 pcs, small paper box



B02114 4/-/40/320
10 13 124 100 GP 24AU



www.emos.eu

Order Code
Item Number

Packaging
Type

- chemical constitution: alkaline
- type: LR03 (AAA battery)
- voltage: 1.5 V
- dimensions: 10.5 × 44.5 mm
- weight: 11.5 g
- operating temperature: -18 °C to +50 °C
- packaging: 6 pcs, small paper box



B0211V

6/-/72/864

10 13 126 000

GP 24AU

- chemical constitution: alkaline
- type: LR03 (AAA battery)
- voltage: 1.5 V
- dimensions: 10.5 × 44.5 mm
- weight: 11.5 g
- operating temperature: -18 °C to +50 °C
- packaging: 8 pcs, small paper box



B02118

8/-/96/768

10 13 128 100

GP 24AU

- chemical constitution: alkaline
- type: LR6 (AA battery)
- voltage: 1.5 V
- dimensions: 14.5 × 50.5 mm
- weight: 23 g
- operating temperature: -18 °C to +50 °C
- packaging: 2 pcs, small paper box



B02212

2/-/20/160

10 14 222 000

GP 15A

- chemical constitution: alkaline
- type: LR6 (AA battery)
- voltage: 1.5 V
- dimensions: 14.5 × 50.5 mm
- weight: 23 g
- operating temperature: -18 °C to +50 °C
- packaging: 4 pcs, small paper box



B02214

4/-/40/320

10 13 224 100

GP 15AU

- chemical constitution: alkaline
- type: LR6 (AA battery)
- voltage: 1.5 V
- dimensions: 14.5 × 50.5 mm
- weight: 23 g
- operating temperature: -18 °C to +50 °C
- packaging: 6 pcs, small paper box



B0221V

6/-/72/576

10 13 226 000

GP 15AU



www.emos.eu

Order Code
Item Number

Packaging
Type

- chemical constitution: alkaline
- type: LR6 (AA battery)
- voltage: 1.5 V
- dimensions: 14.5 × 50.5 mm
- weight: 23 g
- operating temperature: -18 °C to +50 °C
- packaging: 8 pcs, small paper box



B02218

8-/96/576

10 13 228 100

GP 15AU

- chemical constitution: alkaline
- type: LR14 (C battery)
- voltage: 1.5 V
- dimensions: 26.2 × 50.0 mm
- weight: 68 g
- operating temperature: -18 °C to +50 °C
- packaging: 2 pcs, small paper box



B02312

2-/20/160

10 13 322 100

GP 14AU

- chemical constitution: alkaline
- type: LR20 (D battery)
- voltage: 1.5 V
- dimensions: 34.2 × 61.5 mm
- weight: 140 g
- operating temperature: -18 °C to +50 °C
- packaging: 2 pcs, small paper box



B02412

2-/20/80

10 13 422 100

GP 13AU

- chemical constitution: alkaline
- type: 6LR61 9 V
- voltage: 9 V
- dimensions: 26.5 × 17.5 × 48.5 mm
- weight: 47 g
- operating temperature: -18 °C to +50 °C
- packaging: 1 pc, small paper box



B02511

1-/10/200

10 13 521 100

GP 1604AU

GP Super



- basic series of GP alkaline batteries
- for use in devices with low power consumption
- up to 7× more energy than standard zinc-carbon batteries
- operating temperature from -20 °C to +54 °C
- shelf life up to 10 years



- chemical constitution: alkaline
- type: LR03 (AAA battery)
- voltage: 1.5 V
- dimensions: 10.5 × 44.5 mm
- weight: 11.5 g
- operating temperature: -18 °C to +50 °C
- packaging: 2 pcs, shrink



B01102 2/40/200/1 000
10 13 102 002 GP24A

- chemical constitution: alkaline
- type: LR03 (AAA battery)
- voltage: 1.5 V
- dimensions: 10.5 × 44.5 mm
- weight: 11.5 g
- operating temperature: -18 °C to +50 °C
- packaging: 4 pcs, small paper box



B01114 4/-/40/320
10 13 124 200 GP 24A

- chemical constitution: alkaline
- type: LR03 (AAA battery)
- voltage: 1.5 V
- dimensions: 10.5 × 44.5 mm
- weight: 11.5 g
- operating temperature: -18 °C to +50 °C
- packaging: 8 pcs, small paper box



B01118 8/-/96/768
10 13 128 000 GP 24A

- chemical constitution: alkaline
- type: LR03 (AAA battery)
- voltage: 1.5 V
- dimensions: 10.5 × 44.5 mm
- weight: 11.5 g
- operating temperature: -18 °C to +50 °C
- packaging: 10 pc, small paper box



B0111G 10/-/60/480
10 13 121 001 GP 24A



www.emos.eu

Order Code
Item Number

Packaging
Type

- chemical constitution: alkaline
- type: LR03 (AAA battery)
- voltage: 1.5 V
- dimensions: 10.5 × 44.5 mm
- weight: 11.5 g
- operating temperature: -18 °C to +50 °C
- packaging: 20 pcs, shrink



B0110L 20/-/320/960
10 13 122 001 GP 24A

- chemical constitution: alkaline
- type: LR03 (AAA battery)
- voltage: 1.5 V
- dimensions: 10.5 × 44.5 mm
- weight: 11.5 g
- operating temperature: -18 °C to +50 °C
- packaging: 288 pcs, display box



B0114T 288/-/288/1 152
10 13 101 201 GP 24A

- chemical constitution: alkaline
- type: LR6 (AA battery)
- voltage: 1.5 V
- dimensions: 14.5 × 50.5 mm
- weight: 23 g
- operating temperature: -18 °C to +50 °C
- packaging: 2 pcs, shrink



B0120Z 2/40/200/600
10 13 202 002 GP 15A

- chemical constitution: alkaline
- type: LR6 (AA battery)
- voltage: 1.5 V
- dimensions: 14.5 × 50.5 mm
- weight: 23 g
- operating temperature: -18 °C to +50 °C
- packaging: 4 pcs, small paper box



B01214 4/-/40/320
10 13 224 200 GP 15A

- chemical constitution: alkaline
- type: LR6 (AA battery)
- voltage: 1.5 V
- dimensions: 14.5 × 50.5 mm
- weight: 23 g
- operating temperature: -18 °C to +50 °C
- packaging: 8 pcs, small paper box



B01218 8/-/96/576
10 13 228 000 GP 15A



www.emos.eu

Order Code
Item Number

Packaging
Type

- chemical constitution: alkaline
- type: LR6 (AA battery)
- voltage: 1.5 V
- dimensions: 14.5 × 50.5 mm
- weight: 23 g
- operating temperature: -18 °C to +50 °C
- packaging: 10 pc, small paper box



B0121G 10/-/60/480
10 13 221 001 GP 15A

- chemical constitution: alkaline
- type: LR6 (AA battery)
- voltage: 1.5 V
- dimensions: 14.5 × 50.5 mm
- weight: 23 g
- operating temperature: -18 °C to +50 °C
- packaging: 20 pcs, shrink



B0120L 20/-/240/480
10 13 222 001 GP 15A

- chemical constitution: alkaline
- type: LR6 (AA battery)
- voltage: 1.5 V
- dimensions: 14.5 × 50.5 mm
- weight: 23 g
- operating temperature: -18 °C to +50 °C
- packaging: 288 pcs, display box



B0124T 288/-/-/576
10 13 201 201 GP 15A

- chemical constitution: alkaline
- type: LR14 (C battery)
- voltage: 1.5 V
- dimensions: 26.2 × 50.0 mm
- weight: 68 g
- operating temperature: -18 °C to +50 °C
- packaging: 2 pcs, shrink



B01302 2/-/24/192
10 13 302 001 GP 14A

- chemical constitution: alkaline
- type: LR14 (C battery)
- voltage: 1.5 V
- dimensions: 26.2 × 50.0 mm
- weight: 68 g
- operating temperature: -18 °C to +50 °C
- packaging: 4 pcs, shrink



B01304 4/48/-/192
10 13 304 001 GP 14A



www.emos.eu

Order Code
Item Number

Packaging
Type

- chemical constitution: alkaline
- type: LR14 (C battery)
- voltage: 1.5 V
- dimensions: 26.2 × 50.0 mm
- weight: 68 g
- operating temperature: -18 °C to +50 °C
- packaging: 2 pcs, small paper box



B01312 2/-/20/160
10 13 322 200 GP 14A

- chemical constitution: alkaline
- type: LR20 (D battery)
- voltage: 1.5 V
- dimensions: 34.2 × 61.5 mm
- weight: 140 g
- operating temperature: -18 °C to +50 °C
- packaging: 2 pcs, shrink



B01402 2/-/20/80
10 13 402 001 GP 13A

- chemical constitution: alkaline
- type: LR20 (D battery)
- voltage: 1.5 V
- dimensions: 34.2 × 61.5 mm
- weight: 140 g
- operating temperature: -18 °C to +50 °C
- packaging: 4 pcs, shrink



B01404 4/48/-/96
10 13 404 001 GP 13A

- chemical constitution: alkaline
- type: LR20 (D battery)
- voltage: 1.5 V
- dimensions: 34.2 × 61.5 mm
- weight: 140 g
- operating temperature: -18 °C to +50 °C
- packaging: 2 pcs, small paper box



B01412 2/-/20/80
10 13 422 200 GP 13A

- chemical constitution: alkaline
- type: 6LR61 9 V
- voltage: 9 V
- dimensions: 26.5 × 17.5 × 48.5 mm
- weight: 47 g
- operating temperature: -18 °C to +50 °C
- packaging: 1 pc, shrink



B01501 1/10/50/300
10 13 501 001 GP 1604A

- chemical constitution: alkaline
- type: 6LR61 9 V
- voltage: 9 V
- dimensions: 26.5 × 17.5 × 48.5 mm
- weight: 47 g
- operating temperature: -18 °C to +50 °C
- packaging: 1 pc, small paper box



B01511

1/-/10/200

10 13 521 200

GP 1604A

- chemical constitution: alkaline
- type: LR6 (AA battery)/LR03 (AAA battery)
- voltage: 1.5 V
- weight: 23 g
- operating temperature: -18 °C to +50 °C
- packaging: 2 304 pcs (AA) + 1 728 pcs (AAA)



B0125T

1/-/-/1

10 13 800 000

GP 15A

GP Batteries

GP Consumer batteries

GP Carbon Zinc

GP Greencell



- advanced version of zinc-carbon batteries
- operating temperature from -20 °C to +40 °C
- shelf life up to 3 years



- chemical constitution: zinc-chloride
- type: R6 (AA battery)
- voltage: 1.5 V
- dimensions: 14.5 × 50.5 mm
- weight: 17.3 g
- operating temperature: 0 °C to +45 °C
- packaging: 4 pcs, shrink



B1220

4/40/200/1 000

10 12 204 000

GP 15G



- chemical constitution: zinc-chloride
- type: R6 (AA battery)
- voltage: 1.5 V
- dimensions: 14.5 × 50.5 mm
- weight: 17.3 g
- operating temperature: 0 °C to +45 °C
- packaging: 12 pcs, shrink



B1220F 12-/204/612
10 12 209 002 GP 15G

- chemical constitution: zinc-chloride
- type: R6 (AA battery)
- voltage: 1.5 V
- dimensions: 14.5 × 50.5 mm
- weight: 17.3 g
- operating temperature: 0 °C to +45 °C
- packaging: 4 pcs, blister



B1221 4-/172/288
10 12 214 000 GP 15G

- chemical constitution: zinc-chloride
- type: R03 (AAA battery)
- voltage: 1.5 V
- dimensions: 10.5 × 44.5 mm
- weight: 8.5 g
- operating temperature: 0 °C to +45 °C
- packaging: 4 pcs, shrink



B12104 4/40/200/1 000
10 12 104 000 GP 24G

- chemical constitution: zinc-chloride
- type: R03 (AAA battery)
- voltage: 1.5 V
- dimensions: 10.5 × 44.5 mm
- weight: 8.5 g
- operating temperature: 0 °C to +45 °C
- packaging: 12 pcs, shrink



B1210F 12-/204/612
10 12 109 002 GP 24G

- chemical constitution: zinc-chloride
- type: R03 (AAA battery)
- voltage: 1.5 V
- dimensions: 10.5 × 44.5 mm
- weight: 8.5 g
- operating temperature: 0 °C to +45 °C
- packaging: 4 pcs, blister



B1211 4-/40/480
10 12 114 000 GP 24G

- chemical constitution: zinc-chloride
- type: R14 (C battery)
- voltage: 1.5 V
- dimensions: 26.2 × 50.0 mm
- weight: 48 g
- operating temperature: 0 °C to +45 °C
- packaging: 2 pcs, shrink



B1230

2/-/24/240

10 12 302 000

GP 14G



- chemical constitution: zinc-chloride
- type: R14 (C battery)
- voltage: 1.5 V
- dimensions: 26.2 × 50.0 mm
- weight: 48 g
- operating temperature: 0 °C to +45 °C
- packaging: 2 pcs, blister



B1231

2/-/20/240

10 12 312 000

GP 14G



- chemical constitution: zinc-chloride
- type: R20 (D battery)
- voltage: 1.5 V
- dimensions: 34.2 × 61.5 mm
- weight: 97 g
- operating temperature: 0 °C to +45 °C
- packaging: 2 pcs, shrink



B1240

2/-/20/120

10 12 402 000

GP 13G



- chemical constitution: zinc-chloride
- type: R20 (D battery)
- voltage: 1.5 V
- dimensions: 34.2 × 61.5 mm
- weight: 97 g
- operating temperature: 0 °C to +45 °C
- packaging: 2 pcs, blister



B1241

2/-/20/120

10 12 412 000

GP 13G



- chemical constitution: zinc-chloride
- type: 6F22 9 V (1604)
- voltage: 9 V
- dimensions: 26.5 × 17.5 × 48.5 mm
- weight: 36 g
- operating temperature: 0 °C to +45 °C
- packaging: 1 pc, shrink



B1250

1/10/-/300

10 12 501 000

GP 1604GLF





- chemical constitution: zinc-chloride
- type: 6F22 9 V (1604)
- voltage: 9 V
- dimensions: 26.5 × 17.5 × 48.5 mm
- weight: 36 g
- operating temperature: 0 °C to +45 °C
- packaging: 1 pc, blister



B1251 1/-/10/200
10 12 511 000 GP 1604GLF

- chemical constitution: zinc-chloride
- type: 3R12 4.5 V (lantern battery)
- voltage: 4.5 V
- dimensions: 62 × 22 × 67 mm
- weight: 115 g
- operating temperature: 0 °C to +45 °C
- packaging: 1 pc, shrink



B1260 1/-/20/120
10 12 601 000 GP 312G

GP Supercell

- for devices with low power consumption
- operating temperature from -20 °C to +40 °C
- shelf life up to 3 years



- chemical constitution: zinc-carbon
- type: R6 (AA battery)
- voltage: 1.5 V
- dimensions: 14.5 × 50.5 mm
- weight: 14.6 g
- operating temperature: 0 °C to +45 °C
- packaging: 2 pcs, shrink



B11202 2/40/200/800
10 11 202 001 GP 15PL

- chemical constitution: zinc-carbon
- type: R03 (AAA battery)
- voltage: 1.5 V
- dimensions: 10.5 × 44.5 mm
- weight: 8.5 g
- operating temperature: 0 °C to +45 °C
- packaging: 2 pcs, shrink



B1110 2/40/200/1 000
10 11 102 000 GP 24PL

GP Batteries

GP Consumer batteries

GP Other batteries

GP Lithium cylindrical



- 1/3rd lighter and 7× stronger than standard alkaline batt.
- use modern technologies for maximum battery safety
- best choice for professionals
- for capturing up to 800 photos
- outstanding performance at high power consumption
- ideal for extremes of between -40 °C to +60 °C
- extremely long shelf life of up to 10 years

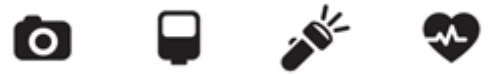

- chemical constitution: lithium
- type: FR6 (AA battery)
- voltage: 1.5 V
- dimensions: 14.5 × 50.5 mm
- weight: 14.5 g
- operating temperature: -40 °C to +60 °C
- packaging: 2 pcs, blister



B15212

2/-/20/160

10 22 000 711

GP 15LF

- chemical constitution: lithium
- type: FR03 (AAA battery)
- voltage: 1.5 V
- dimensions: 10.5 × 44.5 mm
- weight: 7.5 g
- operating temperature: -30 °C to +60 °C
- packaging: 2 pcs, blister



B15112

2/-/20/160

10 22 000 412

GP 24LF

- chemical constitution: lithium
- type: CR-V9 (U9VL,1604LC)
- voltage: 9 V
- dimensions: 26.5 × 17.5 × 48.5 mm
- weight: 34 g
- operating temperature: -40 °C to +60 °C
- packaging: 1 pc, blister



B1509

1/-/10/450

10 22 000 911

GP CR-V9



www.emos.eu

Order Code
Item Number

Packaging
Type

- chemical constitution: lithium
- type: CR123A (CR123AP, CR17345)
- voltage: 3 V
- capacity: 1 500 mAh
- dimensions: 17.0 × 34.5 mm
- weight: 16 g
- operating temperature: -40 °C to +60 °C
- packaging: 1 pc, blister



B1501

1/-/10/450

10 22 000 111

GP CR123A

- chemical constitution: lithium
- type: CR-P2 (EL223AP, DL223A)
- voltage: 6 V
- capacity: 1 400 mAh
- dimensions: 34.8 × 19.5 × 35.8 mm
- weight: 37 g
- operating temperature: -40 °C to +60 °C
- packaging: 1 pc, blister



B1502

1/-/10/450

10 22 000 211

GP CR-P2

- chemical constitution: lithium
- type: 2CR5 (EL2CR5BP, DL245)
- voltage: 6 V
- capacity: 1 400 mAh
- dimensions: 34 × 17 × 45 mm
- weight: 40 g
- operating temperature: -40 °C to +60 °C
- packaging: 1 pc, blister



B1505

1/10/-/450

10 22 000 511

GP 2CR5

- chemical constitution: lithium
- type: CR2 (DLCR2)
- voltage: 3 V
- capacity: 800 mAh
- dimensions: 15.3 × 26.5 mm
- weight: 10 g
- operating temperature: -40 °C to +60 °C
- packaging: 1 pc, blister



B1506

1/-/10/450

10 22 000 611

GP CR2

- chemical constitution: lithium
- type: CR123A (CR123A Econ, CR17345)
- voltage: 3 V
- capacity: 1 400 mAh
- dimensions: 17.0 × 34.5 mm
- weight: 16 g
- operating temperature: -40 °C to +60 °C
- packaging: 1 pc, blister



B1501E

1/-/10/450

10 22 000 114

CR123AE

GP Lithium button



- wide range of packaging, size and model
- wide range of operating temperatures: -10 °C to +60 °C
- shelf life up to 10 years

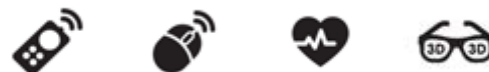

- chemical constitution: lithium
- type: GP CR1/3N
- voltage: 3 V
- capacity: 160 mAh
- dimensions: 11.6 × 10.8 mm
- weight: 3.3 g
- operating temperature: -20 °C to +60 °C
- packaging: 1 pc, blister



B15711 1/-/10/720
10 42 103 011 GP CR1/3N

- chemical constitution: lithium
- type: GP CR1025
- voltage: 3 V
- capacity: 30 mAh
- dimensions: 10.0 × 2.5 mm
- weight: 0.7 g
- operating temperature: -20 °C to +60 °C
- packaging: 1 pc, blister



B15101 1/-/10/900
10 42 102 511 GP CR1025

- chemical constitution: lithium
- type: GP CR1216
- voltage: 3 V
- capacity: 30 mAh (discharge load 30 kOhm)
- dimensions: 12.5 × 1.6 mm
- weight: 0.6 g
- operating temperature: -20 °C to +60 °C
- packaging: 1 pc, blister



B15651 1/10/100/900
10 42 121 611 GP CR1216

- chemical constitution: lithium
- type: GP CR1220
- voltage: 3 V
- capacity: 36 mAh (discharge load 30 kOhm)
- dimensions: 12.5 × 2.0 mm
- weight: 0.8 g
- operating temperature: -20 °C to +60 °C
- packaging: 1 pc, blister



B15201 1/10/100/900
10 42 122 011 GP CR1220



www.emos.eu

Order Code
Item Number

Packaging
Type

- chemical constitution: lithium
- type: GP CR1220
- voltage: 3 V
- capacity: 36 mAh (discharge load 30 kOhm)
- dimensions: 12.5 × 2.0 mm
- weight: 0.8 g
- operating temperature: -20 °C to +60 °C
- packaging: 5 pcs, blister



B1520 5/-/100/2 000
10 42 122 015 GP CR1220

- chemical constitution: lithium
- type: GP CR1225
- voltage: 3 V
- capacity: 62 mAh
- dimensions: 12.5 × 2.5 mm
- weight: 1.0 g
- operating temperature: -20 °C to +60 °C
- packaging: 1 pc, blister



B15221 1/-/10/900
10 42 122 511 GP CR1225

- chemical constitution: lithium
- type: GP CR1616
- voltage: 3 V
- capacity: 50 mAh
- dimensions: 16.0 × 1.6 mm
- weight: 1.1 g
- operating temperature: -20 °C to +60 °C
- packaging: 1 pc, blister



B15601 1/10/100/900
10 42 161 611 GP CR1616

- chemical constitution: lithium
- type: GP CR1620
- voltage: 3 V
- capacity: 75 mAh
- dimensions: 16.0 × 2.0 mm
- weight: 1.3 g
- operating temperature: -20 °C to +60 °C
- packaging: 1 pc, blister



B15701 1/10/100/900
10 42 162 011 GP CR1620

- chemical constitution: lithium
- type: GP CR1620
- voltage: 3 V
- capacity: 75 mAh
- dimensions: 16.0 × 2.0 mm
- weight: 1.3 g
- operating temperature: -20 °C to +60 °C
- packaging: 5 pcs, blister



B1570 5/-/100/2 000
10 42 162 015 GP CR1620



www.emos.eu

Order Code
Item Number

Packaging
Type

- chemical constitution: lithium
- type: GP CR1632
- voltage: 3 V
- capacity: 140 mAh
- dimensions: 16.0 × 3.2 mm
- weight: 1.8 g
- operating temperature: -20 °C to +60 °C
- packaging: 1 pc, blister



B15951 1/10/100/900
10 42 163 221 GP CR1632

- chemical constitution: lithium
- type: GP CR2016
- voltage: 3 V
- capacity: 90 mAh
- dimensions: 20.0 × 1.6 mm
- weight: 1.5 g
- operating temperature: -20 °C to +60 °C
- packaging: 1 pc, blister



B15161 1/10/100/900
10 42 201 611 GP CR2016

- chemical constitution: lithium
- type: GP CR2016
- voltage: 3 V
- capacity: 90 mAh
- dimensions: 20.0 × 1.6 mm
- weight: 1.5 g
- operating temperature: -20 °C to +60 °C
- packaging: 2 pcs, blister



B15163 2/-/20/720
10 42 201 612 GP CR2016

- chemical constitution: lithium
- type: GP CR2016
- voltage: 3 V
- capacity: 90 mAh
- dimensions: 20.0 × 1.6 mm
- weight: 1.5 g
- operating temperature: -20 °C to +60 °C
- packaging: 5 pcs, blister



B1516 5/-/200/2 000
10 42 201 615 GP CR2016

- chemical constitution: lithium
- type: GP CR2025
- voltage: 3 V
- capacity: 165 mAh
- dimensions: 20.0 × 2.5 mm
- weight: 2.5 g
- operating temperature: -20 °C to +60 °C
- packaging: 1 pc, blister



B15251 1/10/100/900
10 42 202 511 GP CR2025

- chemical constitution: lithium
- type: GP CR2025
- voltage: 3 V
- capacity: 165 mAh
- dimensions: 20.0 × 2.5 mm
- weight: 2.5 g
- operating temperature: -20 °C to +60 °C
- packaging: 2 pcs, blister



B15253

2/-/20/720

10 42 202 512

GP CR2025

- chemical constitution: lithium
- type: GP CR2025
- voltage: 3 V
- capacity: 165 mAh
- dimensions: 20.0 × 2.5 mm
- weight: 2.5 g
- operating temperature: -20 °C to +60 °C
- packaging: 5 pcs, blister



B1525

5/-/100/2 000

10 42 202 515

GP CR2025

- chemical constitution: lithium
- type: GP CR2032
- voltage: 3 V
- capacity: 240 mAh
- dimensions: 20.0 × 3.2 mm
- weight: 3.1 g
- operating temperature: -20 °C to +60 °C
- packaging: 1 pc, blister



B15322

1/10/100/900

10 42 203 211

GP CR2032

- chemical constitution: lithium
- type: GP CR2032
- voltage: 3 V
- capacity: 240 mAh
- dimensions: 20.0 × 3.2 mm
- weight: 3.1 g
- operating temperature: -20 °C to +60 °C
- packaging: 2 pcs, blister



B15323

2/20/-/720

10 42 203 212

GP CR2032

- chemical constitution: lithium
- type: GP CR2032
- voltage: 3 V
- capacity: 240 mAh
- dimensions: 20.0 × 3.2 mm
- weight: 3.1 g
- operating temperature: -20 °C to +60 °C
- packaging: 5 pcs, blister



B1532

5/-/100/2 000

10 42 203 215

GP CR2032

- chemical constitution: lithium
- type: GP CR2320
- voltage: 3 V
- capacity: 130 mAh
- dimensions: 23.0 × 2.0 mm
- weight: 3,0 g
- operating temperature: -20 °C to +60 °C
- packaging: 1 pc, blister



B15451 1/-/10/900
10 42 232 011 GP CR2320

- chemical constitution: lithium
- type: GP CR2325
- voltage: 3 V
- capacity: 190 mAh
- dimensions: 23.0 × 2.5 mm
- weight: 3,3 g
- operating temperature: -20 °C to +60 °C
- packaging: 1 pc, blister



B15431 1/-/10/900
10 42 232 511 GP CR2325

- chemical constitution: lithium
- type: GP CR2330
- voltage: 3 V
- capacity: 260 mAh
- dimensions: 23.0 × 3.0 mm
- weight: 4,0 g
- operating temperature: -20 °C to +60 °C
- packaging: 1 pc, blister



B15441 1/-/10/900
10 42 233 011 GP CR2330

- chemical constitution: lithium
- type: GP CR2354
- voltage: 3 V
- capacity: 560 mAh
- dimensions: 23.0 × 5.4 mm
- weight: 6,9 g
- operating temperature: -20 °C to +60 °C
- packaging: 1 pc, blister



B15231 1/-/10/900
10 42 235 411 CR2354

- chemical constitution: lithium
- type: GP CR2430
- voltage: 3 V
- capacity: 300 mAh
- dimensions: 24.5 × 3.0 mm
- weight: 4,3 g
- operating temperature: -20 °C to +60 °C
- packaging: 1 pc, blister



B15301 1/10/100/900
10 42 243 011 GP CR2430



www.emos.eu

Order Code
Item Number

Packaging
Type

- chemical constitution: lithium
- type: GP CR2430
- voltage: 3 V
- capacity: 300 mAh
- dimensions: 24.5 × 3.0 mm
- weight: 4.3 g
- operating temperature: -20 °C to +60 °C
- packaging: 5 pcs, blister



B1530

5/100/-/1 000

10 42 243 015

GP CR2430

- chemical constitution: lithium
- type: GP CR2450
- voltage: 3 V
- capacity: 590 mAh
- dimensions: 24.5 × 5.0 mm
- weight: 6.6 g
- operating temperature: -20 °C to +60 °C
- packaging: 1 pc, blister



B15851

1/-/10/600

10 42 245 011

GP CR2450

- chemical constitution: lithium
- type: GP CR2450
- voltage: 3 V
- capacity: 590 mAh
- dimensions: 24.5 × 5.0 mm
- weight: 6.6 g
- operating temperature: -20 °C to +60 °C
- packaging: 5 pcs, blister



B1585

5/-/100/1 000

10 42 245 015

GP CR2450

- chemical constitution: lithium
- type: GP CR2477
- voltage: 3 V
- capacity: 590 mAh
- dimensions: 24.5 × 7.7 mm
- weight: 6.6 g
- operating temperature: -20 °C to +60 °C
- packaging: 1 pc, blister



B15771

1/-/10/600

10 42 247 711

GP CR2477

- chemical constitution: lithium
- type: GP CR3032
- voltage: 3 V
- capacity: 500 mAh
- dimensions: 30.0 × 3.2 mm
- weight: 6.8 g
- operating temperature: -20 °C to +60 °C
- packaging: 1 pc, blister



B15331

1/-/10/600

10 42 303 211

GP CR3032



www.emos.eu

Order Code
Item Number

Packaging
Type

- chemical constitution: lithium
- type: GP CR2025
- voltage: 3 V
- capacity: 165 mAh
- dimensions: 20.0 × 2.5 mm
- weight: 2.5 g
- operating temperature: -20 °C to +60 °C
- packaging: 4 pcs, blister



B15254 4/-/40/2 400
10 42 202 514 GP CR2025

- chemical constitution: lithium
- type: CR2032
- voltage: 3 V
- capacity: 240 mAh
- dimensions: 20.0 × 3.2 mm
- weight: 3.1 g
- operating temperature: -20 °C to +60 °C
- packaging: 4 pcs, blister



B15324 4/-/40/2 400
10 42 203 214 GP CR2032

GP Special alkaline

- long-lasting performance
- stable operating voltage
- operating temperature from 0 °C to +45 °C
- shelf life up to 3 years



- chemical constitution: alkaline-special
- type: GP 23AF (V23GA, MN21, A23)
- voltage: 12 V
- capacity: 55 mAh (discharge load 20 kOhm)
- dimensions: 10.22 × 28.2 mm
- weight: 7.9 g
- operating temperature: 0 °C to +45 °C
- packaging: 1 pc, blister



B13001 1/-/10/720
10 21 002 311 GP 23AF

- chemical constitution: alkaline-special
- type: GP 23AF (V23GA, MN21, A23)
- voltage: 12 V
- capacity: 55 mAh (discharge load 20 kOhm)
- dimensions: 10.22 × 28.2 mm
- weight: 7.9 g
- operating temperature: 0 °C to +45 °C
- packaging: 5 pcs, blister



B1300 5/-/100/1 000
10 21 002 315 GP 23AF



- chemical constitution: alkaline-special
- type: GP 27A (A27, MN27, A90)
- voltage: 12 V
- capacity: 20 mAh (discharge load 20 kOhm)
- dimensions: 8.0 × 28.2 mm
- weight: 4.4 g
- operating temperature: 0 °C to +45 °C
- packaging: 1 pc, blister



B13011 1/10/-/600
10 21 002 711 GP 27AF

- chemical constitution: alkaline-special
- type: GP 27A (A27, MN27, A90)
- voltage: 12 V
- capacity: 20 mAh (discharge load 20 kOhm)
- dimensions: 8.0 × 28.2 mm
- weight: 4.4 g
- operating temperature: 0 °C to +45 °C
- packaging: 5 pcs, blister



B1301 5/-/100/1 000
10 21 002 715 GP 27AF

- chemical constitution: alkaline-special
- type: GP 11AF
- voltage: 6 V
- capacity: 38 mAh (discharge load 10 kOhm)
- dimensions: 10.22 × 16.5 mm
- weight: 4.0 g
- operating temperature: 0 °C to +45 °C
- packaging: 1 pc, blister



B13021 1/-/10/720
10 21 001 111 GP 11AF

- chemical constitution: alkaline-special
- type: GP 11AF
- voltage: 6 V
- capacity: 38 mAh (discharge load 10 kOhm)
- dimensions: 10.22 × 16.5 mm
- weight: 4.0 g
- operating temperature: 0 °C to +45 °C
- packaging: 5 pcs, blister



B1302 5/-/100/1 000
10 21 001 115 GP 11AF

- chemical constitution: alkaline-special
- type: GP 476AF (4LR44, PX28A, V4034PX)
- voltage: 6 V
- capacity: 105 mAh (discharge load 6 kOhm)
- dimensions: 13.0 × 25.2 mm
- weight: 10 g
- operating temperature: 0 °C to +45 °C
- packaging: 1 pc, blister



B1303 1/-/10/600
10 21 047 612 GP 476AF



www.emos.eu

Order Code
Item Number

Packaging
Type

- chemical constitution: alkaline-special
- type: GP 910A (N, LR1)
- voltage: 1.5 V
- capacity: 885 mAh (discharge load 20 kOhm)
- dimensions: 12.0 × 30.2 mm
- weight: 9 g
- operating temperature: 0 °C to +45 °C
- packaging: 2 pcs, blister



B1305

2/-/20/160

10 21 091 012

GP 910A

- chemical constitution: alkaline-special
- type: GP 25A (AAAA, LR61, LR8, MN2500)
- voltage: 1.5 V
- capacity: 525 mAh (discharge load 42 kOhm)
- dimensions: 8.3 × 42.5 mm
- weight: 6.8 g
- operating temperature: 0 °C to +45 °C
- packaging: 2 pcs, blister



B1306

2/-/20/160

10 21 002 512

GP 25A

- chemical constitution: alkaline-special
- type: GP 29A (A29, 32A, A32, L822)
- voltage: 9 V
- dimensions: 8.0 × 21.9 mm
- weight: 3.5 g
- operating temperature: 0 °C to +45 °C
- packaging: 1 pc, blister



B13951

1/-/10/600

10 21 002 911

GP 29AF

GP Alkaline button



- long-lasting performance
- voltage of 1.5 V
- operating temperature 0 °C to +45 °C
- shelf life up to 3 years



- chemical constitution: alkaline
- type: GP A76F (AG13, LR44, LR1154, V13GA, PX76A)
- voltage: 1.5 V
- capacity: 110 mAh (discharge load 1.6 kOhm)
- dimensions: 11.6 × 5.4 mm
- weight: 1.7 g
- operating temperature: 0 °C to +45 °C
- packaging: 1 pc, blister

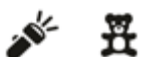

B13762

1/-/10/750

10 41 007 611

GP A76F



- chemical constitution: alkaline
- type: GP A76F (AG13, LR44, LR1154, V13GA, PX76A)
- voltage: 1.5 V
- capacity: 110 mAh (discharge load 1.6 kOhm)
- dimensions: 11.6 × 5.4 mm
- weight: 1.7 g
- operating temperature: 0 °C to +45 °C
- packaging: 5 pcs, blister

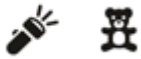

B1376 5/-/100/1 000
10 41 007 615 GP A76F

- chemical constitution: alkaline
- type: GP 186F (AG12, LR43, LR1142, V12GA)
- voltage: 1.5 V
- capacity: 70 mAh (discharge load 1.6 kOhm)
- dimensions: 11.6 × 4.2 mm
- weight: 1.4 g
- operating temperature: 0 °C to +45 °C
- packaging: 1 pc, blister



B13861 1/-/10/750
10 41 018 611 GP 186F

- chemical constitution: alkaline
- type: GP 189F (AG10, LR54, LR1130, V10GA)
- voltage: 1.5 V
- capacity: 44 mAh (discharge load 3.9 kOhm)
- dimensions: 11.6 × 3.05 mm
- weight: 1.0 g
- operating temperature: 0 °C to +45 °C
- packaging: 1 pc, blister

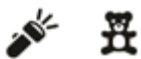

B13892 1/-/10/750
10 41 018 911 GP 189F

- chemical constitution: alkaline
- type: GP 189F (AG10, LR54, LR1130, V10GA)
- voltage: 1.5 V
- capacity: 44 mAh (discharge load 3.9 kOhm)
- dimensions: 11.6 × 3.05 mm
- weight: 1.0 g
- operating temperature: 0 °C to +45 °C
- packaging: 10 pcs, blister

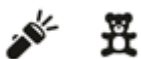

B1389 10/-/250/5 000
10 41 018 910 GP 189F

- chemical constitution: alkaline
- type: GP 192F (LR41, V3GA)
- voltage: 1.5 V
- capacity: 24 mAh (discharge load 30 kOhm)
- dimensions: 7.9 × 3.6 mm
- weight: 0.5 g
- operating temperature: 0 °C to +45 °C
- packaging: 1 pc, blister



B13921 1/-/10/750
10 41 019 211 GP 192F



- chemical constitution: alkaline
- type: GP 192F (LR41, V3GA)
- voltage: 1.5 V
- capacity: 24 mAh (discharge load 6.2 kOhm)
- dimensions: 7.9 × 3.6 mm
- weight: 0.5 g
- operating temperature: 0 °C to +45 °C
- packaging: 5 pcs, blister



B13925

5/-/100/1 000

10 41 019 205

GP 192F



- chemical constitution: alkaline
- type: GP PX625A (LR9, V625U)
- voltage: 1.5 V
- capacity: 190 mAh (discharge load 600 Ohm)
- dimensions: 15.6 × 5.95 mm
- weight: 2.9 g
- operating temperature: 0 °C to +45 °C
- packaging: 1 pc, blister



B1325

1/10/-/750

10 41 062 511

GP 625AF



- chemical constitution: alkaline
- type: GP A76F (AG13, LR44, LR1154, V13GA, PX76A)
- voltage: 1.5 V
- capacity: 110 mAh (discharge load 1.6 kOhm)
- dimensions: 11.6 × 5.4 mm
- weight: 1.7 g
- operating temperature: 0 °C to +45 °C
- packaging: 2 pcs, blister



B13763

2/-/20/1 500

10 41 007 601

GP A76F



GP Silver oxide



- long-lasting performance
- voltage of 1.55 V
- operating temperature from 0 °C to +45 °C
- shelf life up to 3 years



- chemical constitution: silver oxide
- type: GP 357F (SR44, SR1154, V357)
- voltage: 1.55 V
- capacity: 165 mAh (discharge load 3.0 kOhm)
- dimensions: 11.6 × 5.4 mm
- operating temperature: 0 °C to +45 °C
- packaging: 1 pc, blister



B3357F1

1/-/10/750

10 43 035 721

GP 357F





- chemical constitution: silver oxide
- type: GP 377F (SR66, SR626, V377)
- voltage: 1.55 V
- capacity: 24 mAh (discharge load 33 kOhm)
- dimensions: 6.8 × 2.6 mm
- weight: 0.4 g
- operating temperature: 0 °C to +45 °C
- packaging: 1 pc, blister



B3377F1

1/-/10/750

10 43 037 721

GP 377F

- chemical constitution: silver oxide
- type: GP 364F (SR60, SR621, V364)
- voltage: 1.55 V
- capacity: 18 mAh (discharge load 47 kOhm)
- dimensions: 6.8 × 2.15 mm
- weight: 0.36 g
- operating temperature: 0 °C to +45 °C
- packaging: 1 pc, blister



B3364F1

1/10/-/750

10 43 036 431

- chemical constitution: silver oxide
- type: GP 389F (SR54, SR1130, V389)
- voltage: 1.55 V
- capacity: 70 mAh (discharge load 3 kOhm)
- dimensions: 11.6 × 3.05 mm
- operating temperature: 0 °C to +45 °C
- packaging: 1 pc, blister



B3389F1

1/10/-/750

10 43 038 921

- chemical constitution: silver oxide
- type: GP 392F (SR41, SR736, V392)
- voltage: 1.55 V
- capacity: 42 mAh (discharge load 3.0 kOhm)
- dimensions: 7.9 × 3.6 mm
- operating temperature: 0 °C to +45 °C
- packaging: 1 pc, blister



B3392F1

1/10/-/750

10 43 039 221

GP Zinc air



- long lasting power +50 %
- consistent sound quality
- ideal also for latest wireless hearing aid devices
- longer battery tab for easy insertion into hearing aids
- safety and quality assurance
- storage time 4 years
- made in UK



- chemical constitution: zinc-air
- type: GP ZA10 (7005ZD, PR70)
- voltage: 1.45 V
- capacity: 90 mAh (discharge load 1.5 kOhm)
- dimensions: 5.8 × 3.6 mm
- weight: 0.3 g
- operating temperature: -10 °C to +50 °C
- packaging: 6 pcs, blister



B3510 6/60/300/3 000

10 44 001 016 GP ZA10

- chemical constitution: zinc-air
- type: GP ZA13 (7000ZD, PR48)
- voltage: 1.45 V
- capacity: 290 mAh (discharge load 625 Ohm)
- dimensions: 7.9 × 5.4 mm
- weight: 0.8 g
- operating temperature: -10 °C to +50 °C
- packaging: 6 pcs, blister



B3513 6/60/300/3 000

10 44 001 316 GP ZA13

- chemical constitution: zinc-air
- type: GP ZA312 (7002ZD, PR41)
- voltage: 1.45 V
- capacity: 170 mAh (discharge load 1.0 kOhm)
- dimensions: 7.9 × 3.6 mm
- weight: 0.5 g
- operating temperature: -10 °C to +50 °C
- packaging: 6 pcs, blister



B3512 6/60/300/3 000

10 44 031 216 GP ZA312

- chemical constitution: zinc-air
- type: GP ZA675 (7003ZD, PR44)
- voltage: 1.45 V
- capacity: 620 mAh (discharge load 300 Ohm)
- dimensions: 11.6 × 5.4 mm
- weight: 1.8 g
- operating temperature: -10 °C to +50 °C
- packaging: 6 pcs, blister



B3575 6/60/300/3 000

10 44 067 516 GP ZA675

GP Batteries

GP Consumer batteries

GP Rechargeable

GP ReCyko Pro



- high-performance rechargeable batteries with long run time
- at least 1 500 recharge cycles *
- extremely low self-discharge effect *
- charged to 70 % even after 5 years of no use *
- precharged from production – for immediate use
- friendly to the environment and your wallet
- * (valid for Professional line)



- chemical constitution: NiMH
- type: HR03 (AAA battery)
- voltage: 1.2 V
- capacity: 800 mAh
- number of charging cycles: more than 1 500
- dimensions: 10.5 × 44.5 mm
- weight: 14 g
- operating temperature: -20 °C to +50 °C
- packaging: 4 pcs, small paper box



B26184 4/-/40/400

10 32 124 080 85AAHCBP

- chemical constitution: NiMH
- type: HR03 (AAA battery)
- voltage: 1.2 V
- capacity: 800 mAh
- number of charging cycles: more than 1 500
- dimensions: 10.5 × 44.5 mm
- weight: 14 g
- operating temperature: -20 °C to +50 °C
- packaging: 6 pcs, small paper box



B2618V 6/-/60/720

10 32 126 080 85AAHCBP

- chemical constitution: NiMH
- type: HR6 (AA battery)
- voltage: 1.2 V
- capacity: 2 000 mAh
- number of charging cycles: more than 1 500
- dimensions: 14.5 × 50.5 mm
- weight: 30 g
- operating temperature: -20 °C to +50 °C
- packaging: 4 pcs, small paper box



B26204 4/-/40/400

10 32 224 200 210AAHCBP



www.emos.eu

Order Code
Item Number

Packaging
Type

- chemical constitution: NiMH
- type: HR6 (AA battery)
- voltage: 1.2 V
- capacity: 2 000 mAh
- number of charging cycles: more than 500
- dimensions: 14.5 × 50.5 mm
- weight: 30 g
- operating temperature: -20 °C to +50 °C
- packaging: 4 pcs, small paper box



B2629

4/-/40/400

10 32 224 201

210AAHCF

- chemical constitution: NiMH
- type: HR6 (AA battery)
- voltage: 1.2 V
- capacity: 2 000 mAh
- number of charging cycles: more than 1 500
- dimensions: 14.5 × 50.5 mm
- weight: 30 g
- operating temperature: -20 °C to +50 °C
- packaging: 6 pcs, small paper box



B2620V

6/-/60/360

10 32 226 200

210AAHCBP

GP ReCyko



- wide range of capacities and retail packages
- one of the longest run times available on the market
- low self-discharge – charged to 70 % after a year of no use
- precharged from production – for immediate use
- friendly to the environment and your wallet



super strong



1 year storage



ready to use

- chemical constitution: NiMH
- type: HR03 (AAA battery)
- voltage: 1.2 V
- capacity: 650 mAh
- number of charging cycles: more than 1 000
- dimensions: 10.5 × 44.5 mm
- weight: 12 g
- operating temperature: -20 °C to +50 °C
- packaging: 2 pcs, small paper box



B25162

2/-/20/200

10 32 122 062

65AAAHCE

- chemical constitution: NiMH
- type: HR03 (AAA battery)
- voltage: 1.2 V
- capacity: 850 mAh
- number of charging cycles: more than 500
- dimensions: 10.5 × 44.5 mm
- weight: 14.5 g
- operating temperature: -20 °C to +50 °C
- packaging: 2 pcs, small paper box



B25182

2/-/20/200

10 32 122 080

85AAAHCE



www.emos.eu

Order Code
Item Number

Packaging
Type

- chemical constitution: NiMH
- type: HR03 (AAA battery)
- voltage: 1.2 V
- capacity: 950 mAh
- number of charging cycles: more than 500
- dimensions: 10.5 × 44.5 mm
- weight: 15 g
- operating temperature: -20 °C to +50 °C
- packaging: 2 pcs, small paper box



B25112 2/-/20/200
10 32 122 090 100AAHCE

- chemical constitution: NiMH
- type: HR03 (AAA battery)
- voltage: 1.2 V
- capacity: 850 mAh
- number of charging cycles: more than 500
- dimensions: 14.5 × 50.5 mm
- weight: 14.5 g
- operating temperature: -20 °C to +50 °C
- packaging: 4 pcs, small paper box



B25184 4/-/40/400
10 32 124 081 85AAHCE

- chemical constitution: NiMH
- type: HR03 (AAA battery)
- voltage: 1.2 V
- capacity: 950 mAh
- number of charging cycles: more than 500
- dimensions: 10.5 × 44.5 mm
- weight: 15 g
- operating temperature: -20 °C to +50 °C
- packaging: 4 pcs, small paper box



B25114 4/-/40/400
10 32 124 090 100AAHCE

- chemical constitution: NiMH
- type: HR03 (AAA battery)
- voltage: 1.2 V
- capacity: 950 mAh
- number of charging cycles: more than 500
- dimensions: 10.5 × 44.5 mm
- weight: 15 g
- operating temperature: -20 °C to +50 °C
- packaging: 6 pcs, small paper box



B2511V 6/-/60/720
10 32 126 090 100AAHCE

- chemical constitution: NiMH
- type: HR6 (AA battery)
- voltage: 1.2 V
- capacity: 1300 mAh
- number of charging cycles: more than 500
- dimensions: 14.5 × 50.5 mm
- weight: 23 g
- operating temperature: -20 °C to +50 °C
- packaging: 2 pcs, small paper box



B25232 2/-/20/200
10 32 222 131 130AAHCE



www.emos.eu

Order Code
Item Number

Packaging
Type

- chemical constitution: NiMH
- type: HR6 (AA battery)
- voltage: 1.2 V
- capacity: 2 100 mAh
- number of charging cycles: more than 500
- dimensions: 14.5 × 50.5 mm
- weight: 27 g
- operating temperature: -20 °C to +50 °C
- packaging: 2 pcs, small paper box



B25212

2/-/20/200

10 32 222 211

210AAHCE

- chemical constitution: NiMH
- type: HR6 (AA battery)
- voltage: 1.2 V
- capacity: 2 600 mAh
- number of charging cycles: more than 300
- dimensions: 14.5 × 50.5 mm
- weight: 31 g
- operating temperature: -20 °C to +50 °C
- packaging: 2 pcs, small paper box



B25272

2/-/20/200

10 32 222 260

270AAHCE

- chemical constitution: NiMH
- type: HR6 (AA battery)
- voltage: 1.2 V
- capacity: 2 100 mAh
- number of charging cycles: more than 500
- dimensions: 14.5 × 50.5 mm
- weight: 27 g
- operating temperature: -20 °C to +50 °C
- packaging: 4 pcs, small paper box



B25214

4/-/40/400

10 32 224 210

210AAHCE

- chemical constitution: NiMH
- type: HR6 (AA battery)
- voltage: 1.2 V
- capacity: 2 600 mAh
- number of charging cycles: up to 300
- dimensions: 14.5 × 50.5 mm
- weight: 31 g
- operating temperature: -20 °C to +50 °C
- packaging: 4 pcs, small paper box



B25274

4/-/40/400

10 32 224 260

270AAHCE

- chemical constitution: NiMH
- type: HR6 (AA battery)
- voltage: 1.2 V
- capacity: 2 100 mAh
- number of charging cycles: more than 500
- dimensions: 14.5 × 50.5 mm
- weight: 27 g
- operating temperature: -20 °C to +50 °C
- packaging: 6 pcs, small paper box



B2521V

6/-/60/360

10 32 226 212

210AAHCF



www.emos.eu

Order Code
Item Number

Packaging
Type

- chemical constitution: NiMH
- type: HR6 (AA battery)
- voltage: 1.2 V
- capacity: 2 600 mAh
- number of charging cycles: up to 300
- dimensions: 14.5 × 50.5 mm
- weight: 31 g
- operating temperature: -20 °C to +50 °C
- packaging: 6 pcs, small paper box



B2527V 6/-/60/360
10 32 226 260 270AAHCE

- chemical constitution: NiMH
- type: HR14 (C battery)
- voltage: 1.2 V
- capacity: 3 000 mAh
- number of charging cycles: more than 1 000
- dimensions: 26.2 × 50.0 mm
- weight: 60 g
- operating temperature: -20 °C to +50 °C
- packaging: 2 pcs, small paper box



B2533 2/-/12/120
10 32 322 301 300CHC

- chemical constitution: NiMH
- type: HR20 (D battery)
- voltage: 1.2 V
- capacity: 3 000 mAh
- number of charging cycles: more than 1 000
- dimensions: 34.2 × 61.5 mm
- weight: 70 g
- operating temperature: -20 °C to +50 °C
- packaging: 2 pcs, small paper box



B2543 2/-/12/72
10 32 422 300 300DHC

- chemical constitution: NiMH
- type: 6HR61 9 V (1604)
- voltage: 8.4 V
- capacity: 200 mAh
- number of charging cycles: more than 500
- dimensions: 26.5 × 15.7 × 48.5 mm
- weight: 42.5 g
- operating temperature: -20 °C to +50 °C
- packaging: 1 pc, small paper box



B2552 1/-/10/100
10 32 521 021 20R8H

- chemical constitution: NiMH
- type: HR6 (AA battery)
- voltage: 1.2 V
- capacity: 1 700 mAh
- number of charging cycles: more than 700
- dimensions: 14.5 × 50.5 mm
- weight: 26.2 g
- operating temperature: -20 °C to +50 °C
- packaging: 4 pcs, small paper box



B24294 4/-/40/400
10 33 224 170 170AAHCV

Raver Batteries

Raver Lithium cylindrical



- suitable for digital cameras and flashes
- electronic toys, hobby models, MP3 players, PDAs and GPS
- also meet the requirements of healthcare tools and devices
- ideal for use in extreme temperatures of -40 °C to +60 °C
- shelf life up to 10 years



- chemical constitution: lithium
- type: FR03 (AAA battery)
- voltage: 1.5 V
- dimensions: 10.5 × 44.5 mm
- weight: 7.2 g
- operating temperature: -40 °C to +60 °C
- packaging: 2 pcs, blister



B7811

2/-/28/280

13 21 112 000

RLT FR03-B2

- chemical constitution: lithium
- type: FR6 (AA battery)
- voltage: 1.5 V
- dimensions: 14.5 × 50.5 mm
- weight: 15.5 g
- operating temperature: -40 °C to +60 °C
- packaging: 2 pcs, blister



B7821

2/-/20/200

13 21 212 000

RLT FR6-B2

Raver Batteries

Raver Alkaline

Raver Ultra



- top performance in devices with low long-term consumption
- up to 7x more energy than standard zinc-carbon batteries
- operating temperature from -20 °C to +60 °C
- shelf life up to 7 years



- chemical constitution: alkaline
- type: LR03 (AAA battery)
- voltage: 1.5 V
- dimensions: 10.5 × 44.5 mm
- weight: 11.5 g
- operating temperature: -20 °C to +60 °C
- packaging: 4 pcs, blister



B7911

4/-/40/320

13 20 114 000

RUA LR03-B4

- chemical constitution: alkaline
- type: LR03 (AAA battery)
- voltage: 1.5 V
- dimensions: 10.5 × 44.5 mm
- weight: 11.5 g
- operating temperature: -20 °C to +60 °C
- packaging: 8 pcs, shrink



B79118

8/-/96/960

13 20 118 000

RUA LR03-S8

- chemical constitution: alkaline
- type: LR6 (AA battery)
- voltage: 1.5 V
- dimensions: 14.5 × 50.5 mm
- weight: 23,8 g
- operating temperature: -20 °C to +60 °C
- packaging: 4 pcs, blister



B7921

4/-/40/320

13 20 214 000

RUA LR6-B4

- chemical constitution: alkaline
- type: LR6 (AA battery)
- voltage: 1.5 V
- dimensions: 14.5 × 50.5 mm
- weight: 23,8 g
- operating temperature: -20 °C to +60 °C
- packaging: 8 pcs, shrink



B79218 8/-/96/960
13 20 218 000 RUA LR6-S8

Raver Batteries

Raver Rechargeable



- RAVER SOLAR – excellent choice for solar garden lights
- it often only takes a new battery to get a light to work
- rechargeable batteries save both money and the environment
- also usable for other undemanding devices
- operating temperature from -20 °C to +50 °C



- chemical constitution: NiMH
- type: HR03 (AAA battery)
- voltage: 1.2 V
- capacity: 400 mAh
- number of charging cycles: more than 500
- dimensions: 10.5 × 44.5 mm
- weight: 9 g
- operating temperature: -20 °C to +50 °C
- packaging: 2 pcs, blister



B7414 2/-/32/384
13 32 112 040 RAVER SOLAR
AAA

- chemical constitution: NiMH
- type: HR6 (AA battery)
- voltage: 1.2 V
- capacity: 600 mAh
- number of charging cycles: more than 500
- dimensions: 14.5 × 50.5 mm
- weight: 15 g
- operating temperature: -20 °C to +50 °C
- packaging: 2 pcs, blister



B7426 2/-/24/288
13 32 212 030 RAVER SOLAR AA

Raver Batteries

Raver Other batteries

Raver Lithium button



- suitable for devices requiring a stable supply of power
- e.g. watches, calculators, alarms, manometers, etc.
- long service life
- operating temperature from -10 °C to +60 °C
- shelf life up to 10 years



- chemical constitution: lithium
- type: CR2016
- voltage: 3 V
- capacity: 75 mAh (discharge load 30 kOhm)
- dimensions: 20.0 × 1.6 mm
- weight: 1.7 g
- operating temperature: -10 °C to +60 °C
- packaging: 5 pcs, blister



B7316

5/-/150/-/1 800

13 26 021 605

RAVER CR2016

- chemical constitution: lithium
- type: CR2032
- voltage: 3 V
- capacity: 220 mAh (discharge load 15 kOhm)
- dimensions: 20.0 × 3.2 mm
- weight: 3.1 g
- operating temperature: -10 °C to +60 °C
- packaging: 5 pcs, blister



B7332

5/-/150/1 800

13 26 023 205

RAVER CR2032

Batteries EMOS, lead acid battery

Lead acid batteries

- maintenance-free, valve-controlled industrial lead accumulators
- for low-cost powering of devices
- hermetically sealed lead AGM accumulators
- wide range of uses – fire alarms, communication devices, UPS
- optimal service life 5 years

B9651 1/-/-20
12 01 000 500 OT1.3-6 (E613)



8 595025 340818



voltage: 6 V = capacity: 1.3 Ah = weight: 0.3 kg = terminal: faston 4.7 mm = optimal lifetime: 5 years = dimensions: 97 × 24 × 51 mm = packaging: 1 pc

B9641 1/-/-20
12 01 000 100 OT4-6(E640)



8 595025 318732



for lanterns: 3810 (P2301), 3810 LED (P2304), 3810 LED EXPERT (P2305), 3810 10W + COB (P2308) = chemical constitution: Pb = voltage: 6 V = capacity: 4 Ah = dimensions: 70 × 47 × 101 mm = packaging: 1 pc

B9659 1/-/-16
12 01 000 520 OT7-6 (E670)



8 595025 353474



voltage: 6 V = capacity: 7 Ah = weight: 1 kg = terminal: faston 4.7 mm = optimal lifetime: 5 years = dimensions: 151 × 34 × 94 mm = packaging: 1 pc

B9682 1/-/-10
12 01 003 500 OT12-6 (E-6120)



8 592920 005668



voltage: 6 V = capacity: 12 Ah = weight: 1.8 kg = terminal: faston 4.7 mm = optimal lifetime: 5 years = dimensions: 151 × 51 × 94 mm = packaging: 1 pc

B9652 1/-/-20
12 01 000 600 OT1.3-12 (E1213;
E1.3-12)



8 595025 340825



voltage: 12 V = capacity: 1.3 Ah = weight: 0.5 kg = terminal: faston 4.7 mm = optimal lifetime: 5 years = dimensions: 97 × 45 × 53 mm = packaging: 1 pc

B9672 1/-/-20
12 01 002 600 OT2.2-12 (E1222)





8 592920 004159



voltage: 12 V = capacity: 2.2 Ah = weight: 0.95 kg = terminal: faston 4.7 mm = optimal lifetime: 5 years = dimensions: 178 × 35 × 61 mm = packaging: 1 pc



B9653 1/-/-/10
12 01 000 700 OT4.5-12 (E1245)



voltage: 12 V = capacity: 4.5 Ah = weight: 1.46 kg = terminal: faston 4.7 mm = optimal lifetime: 5 years = dimensions: 91 × 71 × 105 mm = packaging: 1 pc

B9679 1/-/-/10
12 01 003 300 OT5-12 (E1250)





voltage: 12 V = capacity: 5 Ah = weight: 1.65 kg = terminal: faston 6.3 mm = optimal lifetime: 5 years = dimensions: 91 × 71 × 105 mm = packaging: 1 pc

B9691 1/-/-/10
12 01 004 300 OT7-12 (E1270)



voltage: 12 V = capacity: 7 Ah = weight: 2.05 kg = terminal: faston 4.7 mm = optimal lifetime: 5 years = dimensions: 151 × 65 × 94 mm = packaging: 1 pc

B9654 1/-/-/10
12 01 000 800 OT7.2-12 (E1272; E7.2-12)



voltage: 12 V = capacity: 7.2 Ah = weight: 2.2 kg = terminal: faston 4.7 mm = optimal lifetime: 5 years = dimensions: 151 × 65 × 94 mm = packaging: 1 pc

B9674 1/-/-/10
12 01 002 800 OT 7.2-12(OT 7.2-12 T2)

voltage: 12 V = capacity: 7.2 Ah = weight: 2.2 kg = terminal: faston 6.3 mm = optimal lifetime: 5 years = dimensions: 151 × 65 × 94 mm = packaging: 1 pc

B9675 1/-/-/10
12 01 002 900 OT9-12 (E1290)



voltage: 12 V = capacity: 9 Ah = weight: 2.42 kg = terminal: faston 6.3 mm = optimal lifetime: 5 years = dimensions: 151 × 65 × 94 mm = packaging: 1 pc

B9656 1/-/-/4
12 01 000 850 OT12-12 (E12120; E12-12)





voltage: 12 V = capacity: 12 Ah = weight: 3.3 kg = terminal: faston 6.3 mm = optimal lifetime: 5 years = dimensions: 151 × 98 × 96 mm = packaging: 1 pc

B9656V 1/-/-/2
12 01 004 800 6-DZM-12



voltage: 12 V = capacity: 15 Ah/20 hrs (14 Ah/10 hrs, 12 Ah/2 hrs) = weight: 4.25 kg = terminal: faston 6.3 mm = optimal lifetime: 4 years for cyclic operation (approx. 1 200 cycles for 30 % D.O.D = discharge depth) = dimensions: 150 × 100 × 102 mm = packaging: 1 pc

B9655 1/-/-/4
12 01 000 900 OT17-12 (E12180; OT 18-12)

voltage: 12 V = capacity: 18 Ah = weight: 4.88 kg = terminal: 12 × 12 × 2 mm = optimal lifetime: 5 years = dimensions: 181 × 77 × 167 mm = packaging: 1 pc

B9683 1/-/-/2
12 01 003 600 OT26-12/W; (E12260)

voltage: 12 V = capacity: 26 Ah = weight: 8.05 kg = terminal: 14 × 12 × 2 mm = optimal lifetime: 5 years = dimensions: 175 × 165 × 125 mm = packaging: 1 pc



www.emos.eu

Order Code
Item Number

Packaging
Type

B9684

1/-/-1

12 01 003 700

OT40-12 (E1240;
E40-12)



8 592920 006412

voltage: 12 V = capacity: 40 Ah = weight: 13.05 kg = terminal: T1 – M6 = optimal
lifetime: 5 years = dimensions: 196 × 166 × 175 mm = packaging: 1 pc

B9685

1/-/-1

12 01 003 800

OT65-12 (E-
12650)



8 592920 006436

voltage: 12 V = capacity: 65 Ah = weight: 20.65 kg = terminal: T2 – M8 = optimal
lifetime: 5 years = dimensions: 350 × 166 × 175 mm = packaging: 1 pc

Battery chargers, powerbanks, USB chargers



Battery chargers

Charge 10



- thanks to the fast charging technology, it reliably charges the batteries in just 10 minutes
- will please with overheating protection or ECO mode for gentle charging of NiMH batteries
- it also has fully automatic intelligent charging and silent operation
- the charger includes 4 environmentally friendly AA batteries that last more than 700 charging cycles

- type of charger: intelligent
- charger design: separated AC cord
- power source: 100-240 V AC
- size of the charged cells: AAA, AA
- number of cells inside the package: 4
- type of cells inside the package: AA ReCyko Charge
- charging time of the enclosed cells: 00:10
- number of charging channels: 4
- number of batteries charged: 1 to 4
- charging current for AA: 10 000 mA
- charging current for AAA: 1 500 mA
- charging time AA 2 700 mAh: 0:30
- charging time AAA 1 000 mAh: 0:45
- packaging: 1 pc, small paper box



B56499

1/-/6/12

16 04 849 120

S491

- chemical constitution: NiMH
- type: HR6 (AA battery)
- voltage: 1.2 V
- capacity: 1 700 mAh
- number of charging cycles: more than 700
- dimensions: 14.5 × 50.5 mm
- weight: 26.2 g
- operating temperature: -20 °C to +50 °C
- packaging: 4 pcs, small paper box



B24294

4/-/40/400

10 33 224 170

170AAHCV

GP Battery chargers



- unique new design concept of NiMH battery chargers
- USB power supply and small size allow you to charge anytime, anywhere
- even basic models offer quick and smart charging
- high-quality GP rechargeable batteries and micro USB cable included
- "Pro" model with LED screen and advanced features



auto on/off



smart diagnostics



charge everywhere

- type of charger: intelligent
- charger design: USB
- power source: USB 5 V/1 A
- size of the charged cells: AAA, AA
- number of cells inside the package: 4
- type of cells inside the package: AA ReCyko 2 700
- charging time of the enclosed cells: 2:45 - 5:30
- number of charging channels: 4
- number of batteries charged: 1 to 4

- charging current for AA: 1 100-550 mA
- charging current for AAA: 730-370 mA
- charging time AA 2 700 mAh: 2:45 - 5:30
- charging time AAA 1 000 mAh: 1:30 - 3:30
- packaging: 1 pc, small paper box



4 hrs charging time



individual charging



ready to use



super strong



1 year storage



4 891199 195075

B53457

1/-/6/12

16 04 845 112

M451

- type of charger: intelligent
- charger design: USB
- power source: USB 5 V/1 A
- size of the charged cells: AAA, AA
- number of cells inside the package: 4
- type of cells inside the package: AA ReCyko Pro
- charging time of the enclosed cells: 2:00 - 4:00
- number of charging channels: 4
- number of batteries charged: 1 to 4

- charging current for AA: 1 100-550 mA
- charging current for AAA: 730-370 mA
- charging time AA 2 700 mAh: 2:45 - 5:30
- charging time AAA 1 000 mAh: 1:30 - 3:30
- packaging: 1 pc, small paper box



4 hrs charging time



individual charging



ready to use



energy lock



5 years storage



4 891199 198335

B53455

1/-/6/12

16 04 845 111

M451

- type of charger: intelligent
- charger design: USB
- power source: USB 5 V/1 A
- size of the charged cells: AAA, AA
- number of charging channels: 4
- number of batteries charged: 1 to 4
- charging current for AA: 1 100-550 mA
- charging current for AAA: 730-370 mA
- charging time AA 2 700 mAh: 2:45 - 5:30

- charging time AAA 1 000 mAh: 1:30 - 3:30
- packaging: 1 pc, small paper box



4 hrs charging time



individual charging



4 891199 198304

B53450

1/-/6/12

16 04 845 110

M451

- type of charger: intelligent
- charger design: USB
- power source: USB 5 V/1 A
- size of the charged cells: AAA, AA
- number of cells inside the package: 2
- type of cells inside the package: AA ReCyko 2 100
- charging time of the enclosed cells: 8:00
- number of charging channels: 1
- number of batteries charged: 2

- charging current for AA: 300 mA
- charging current for AAA: 300 mA
- charging time AA 2 700 mAh: 10:00
- charging time AAA 1 000 mAh: 4:00
- packaging: 1 pc, small paper box



8 hrs charging time



ready to use



1 year storage



300 charging cycles



4 891199 192890

B51214

1/-/-/12

16 04 821 110

E211

- type of charger: intelligent
- charger design: USB
- power source: USB 5 V/1 A
- size of the charged cells: AAA, AA
- number of cells inside the package: 2
- type of cells inside the package: AA ReCyko 2 100
- charging time of the enclosed cells: 8:00
- number of charging channels: 1
- number of batteries charged: 2

- charging current for AA: 300 mA
- charging current for AAA: 300 mA
- charging time AA 2 700 mAh: 10:00
- charging time AAA 1 000 mAh: 4:00
- packaging: 1 pc, small paper box



B50224 1/-/-/12
16 04 822 110 E221

- type of charger: intelligent
- charger design: USB
- power source: USB 5 V/1 A
- size of the charged cells: AAA, AA
- number of cells inside the package: 4
- type of cells inside the package: AA Recharge 1300,
- charging time of the enclosed cells: 2:00 - 4:00
- number of charging channels: 2
- number of batteries charged: 2 or 4

- charging current for AA: 770 mA/380 mA
- charging current for AAA: 300 mA
- charging time AA 2 700 mAh: 4:00 - 8:00
- charging time AAA 1 000 mAh: 4:00
- packaging: 1 pc, small paper box



B50449 1/-/-/12
16 04 844 100 B441

- type of charger: intelligent
- charger design: USB
- power source: USB 5 V/1 A
- size of the charged cells: AAA, AA
- number of cells inside the package: 4
- type of cells inside the package: AA ReCyko 2 100
- charging time of the enclosed cells: 3:00/6:00
- number of charging channels: 2
- number of batteries charged: 2 or 4

- charging current for AA: 770 mA/380 mA
- charging current for AAA: 300 mA
- charging time AA 2 700 mAh: 4:00 - 8:00
- charging time AAA 1 000 mAh: 2:30 - 3:30
- packaging: 1 pc, small paper box



B50444 1/-/-/12
16 04 844 110 B441

- type of charger: intelligent
- charger design: USB
- power source: USB 5 V/1 A
- size of the charged cells: AAA, AA
- number of cells inside the package: 4
- type of cells inside the package: AA ReCyko Pro
- charging time of the enclosed cells: 2:45 - 5:30
- number of charging channels: 4
- number of batteries charged: 1 to 4

- charging current for AA: 1 100-550 mA
- charging current for AAA: 730-370 mA
- charging time AA 2 700 mAh: 2:45 - 5:30
- charging time AAA 1 000 mAh: 1:30 - 3:30
- packaging: 1 pc, small paper box



B50457 1/-/6/12
16 04 845 210 M452

- type of charger: intelligent
- charger design: USB
- power source: USB 5 V/2 A
- size of the charged cells: AAA, AA
- special features: capacity check, docking station
- number of cells inside the package: 4
- type of cells inside the package: AA ReCyko Pro
- charging time of the enclosed cells: 1:20 - 2:40
- number of charging channels: 4

- number of batteries charged: 1 to 4
- charging current for AA: 1 730 mA/ 870 mA
- charging current for AAA: 700 mA/350 mA
- charging time AA 2 700 mAh: 1:45/3:30
- charging time AAA 1 000 mAh: 1:30 - 3:15
- packaging: 1 pc, small paper box



B50460D 1/-/6/12
16 04 846 114 P461



www.emos.eu

Order Code
Item Number

Packaging
Type

- type of charger: intelligent
- charger design: USB
- power source: USB 5 V/1 A
- size of the charged cells: AAA, AA
- number of cells inside the package: 8
- type of cells inside the package: AA ReCyko 2 100, A
- charging time of the enclosed cells: 9:00
- number of charging channels: 4
- number of batteries charged: 2, 4, 6 or 8
- charging current for AA: 250 mA
- charging current for AAA: 250 mA
- charging time AA 2 700 mAh: 10:00
- charging time AAA 1 000 mAh: 5:00
- packaging: 1 pc, small paper box



B50829 1/-/-/12
16 04 882 110 E821

EMOS Battery chargers

- for carefree charging of consumer NiMH batteries
- automatic start and end of charging
- capable of charging any number and size of batteries at the same time
- smart diagnostics and management of the charging process
- high final level of charge of the batteries
- other eco-friendly and safety features
- colour LEDs indicate the state of charge

- type of charger: intelligent
- charger design: USB
- power source: USB 5 V/2 A
- size of the charged cells: 10440 – 26650, AAA, AA, C
- special features: capacity check
- number of charging channels: 2
- number of batteries charged: 1 or 2
- charging current for AA: 1 000 mA
- charging current for AAA: 1 000 mA
- charging current for C: 1 000 mA
- charging time AA 2 700 mAh: 3:00
- charging time AAA 1 000 mAh: 1:15
- packaging: 1 pc, small paper box



N9221 1/-/-/60
16 03 026 000 BCL-20D

- type of charger: intelligent
- charger design: USB
- power source: USB 5 V/1 A
- size of the charged cells: AAA, AA
- number of charging channels: 4
- number of batteries charged: 1 to 4
- charging current for AA: 300 mA
- charging current for AAA: 300 mA
- charging time AA 2 700 mAh: 10:00
- charging time AAA 1 000 mAh: 4:00
- packaging: 1 pc, small paper box



N9321 1/-/-/60
16 03 027 000 BCN-40

- type of charger: intelligent
- charger design: USB
- power source: USB 5 V/1 A
- size of the charged cells: AAA, AA
- number of cells inside the package: 4
- type of cells inside the package: AA NiMH 2 700
- charging time of the enclosed cells: 4:00
- number of charging channels: 4
- number of batteries charged: 1 to 4
- charging current for AA: 1 000/500 mA
- charging current for AAA: 1 000/500 mA
- charging time AA 2 700 mAh: 3:00 - 4:00
- charging time AAA 1 000 mAh: 1:15 - 2:00
- packaging: 1 pc, small paper box



N9331 1/-/-/60
16 03 028 000 BCN-41D



- type of charger: intelligent
- charger design: USB
- power source: USB 5 V/1 A
- size of the charged cells: AAA, AA
- special features: capacity check
- number of cells inside the package: 4
- type of cells inside the package: AA NiMH 2 700
- charging time of the enclosed cells: 3:00
- number of charging channels: 4
- number of batteries charged: 1 to 4
- charging current for AA: 1 000–250 mA
- charging current for AAA: 1 000–250 mA
- charging time AA 2 700 mAh: 3:00 - 12:00
- charging time AAA 1 000 mAh: 1:15 - 5:00
- packaging: 1 pc, small paper box



N9341

1/-/-/40

16 03 029 000

BCN-42D



- type of charger: intelligent
- charger design: USB
- power source: USB 5 V/2 A
- size of the charged cells: AAA, AA, C, D, 9 V
- number of charging channels: 7
- number of batteries charged: 1 to 6
- charging current for AA: 500 mA
- charging current for AAA: 500 mA
- charging current for C: 500 mA
- charging current for D: 500 mA
- charging current for 9 V: 30 mA
- charging time AA 2 700 mAh: 6:30
- charging time AAA 1 000 mAh: 2:30
- packaging: 1 pc, small paper box



N9361

1/-/-/30

16 03 030 000

BCN-60U



Powerbanks

GP Powerbanks



- 7 electronic safety protection features
- Specific models have wireless charging possibility
- All models are able to charge more devices simultaneously
- All models are capable of Light Load charging (for smart-watches, headphones)
- All models are equipped with LED Display or LED indication (MagSafe Wireless model)
- Passthrough function, auto On/Off

- battery capacity: 5 000 mAh/18.5 Wh
- battery type: Li-Po 3.7 V
- fast charging: PD 20 W
- max.input power: 18 W
- type of input interface: 1× USB-C
- charging time: 2 hours
- max.output power: 20 W
- type of output interface: 1× USB-C
- cable included: USB-C/USB-C
- LED charging indicator
- LED battery status indicator
- auto ON/OFF
- passthrough
- material: ABS plastic
- colour: black
- weight: 150 g
- dimensions: 111 × 63 × 18,5 mm



B6305B

1/-/2/20

16 11 630 500

Q05B





www.emos.eu

Order Code
Item Number

Packaging
Type

- battery capacity: 10 000 mAh/37 Wh
- battery type: Li-Po 3.7 V
- fast charging: PD 3.0, QC 3.0, PPS, SCP, FCP, AFC
- max.input power: 18 W
- type of input interface: 1× USB-C
- charging time: 2.5 hours
- max.output power: 22.5 W
- type of output interface: 2× USB-C, 1× USB-A
- cable included: USB-A/USB-C

- LED charging indicator
- LED battery status indicator
- passthrough
- material: ABS plastic
- colour: green
- weight: 240 g
- dimensions: 142 × 67 × 16 mm



B6310G

1/-/2/20

16 11 631 000

GPM10CGR

- battery capacity: 10 000 mAh/37 Wh
- battery type: Li-Po 3.7 V
- fast charging: PD 3.0, QC 3.0, PPS, SCP, FCP, AFC
- max.input power: 18 W
- type of input interface: 1× USB-C
- charging time: 2.5 hours
- max.output power: 22.5 W
- type of output interface: 2× USB-C, 1× USB-A
- cable included: USB-A/USB-C

- LED charging indicator
- LED battery status indicator
- passthrough
- material: ABS plastic
- colour: blue
- weight: 240 g
- dimensions: 142 × 67 × 16 mm



B6310BL

1/-/2/20

16 11 631 001

GPM10CBL

- battery capacity: 10 000 mAh/37 Wh
- battery type: Li-Po 3.7 V
- fast charging: PD 20 W + SCP 22.5 W + Dash + War
- max.input power: 18 W
- type of input interface: 1× USB-C
- charging time: 2.5 hours
- max.output power: 22.5 W
- type of output interface: 2× USB-C, 1× USB-A
- cable included: USB-A/USB-C

- LED charging indicator
- LED battery status indicator
- passthrough
- material: ABS plastic
- colour: beige
- weight: 240 g
- dimensions: 142 × 67 × 16 mm



B6310BE

1/-/2/20

16 11 631 002

GPM10CBE

- battery capacity: 20 000 mAh/74 Wh
- battery type: Li-Po 3.7 V
- fast charging: PD 3.0, QC 3.0, PPS, SCP, FCP, AFC
- max.input power: 18 W
- type of input interface: 1× USB-C
- charging time: 5 hours
- max.output power: 22.5 W
- type of output interface: 2× USB-C, 1× USB-A
- cable included: USB-A/USB-C

- LED charging indicator
- LED battery status indicator
- passthrough
- material: ABS plastic
- colour: grey
- weight: 390 g
- dimensions: 146 × 68 × 29 mm



B6320GY

1/-/2/20

16 11 632 000

GPM20CGY

EMOS Powerbanks

- all models are compatible with USB-C or micro USB devices
- 6 electronic safety protection features
- cables with data transfer function are included
- certain models are featured with quick charge QC3.0 and PD18W
- excellent performance thanks to used high-quality battery and el.
- passthrough function, auto ON/OFF



- battery capacity: 5 000 mAh/18.5 Wh
- battery type: Li-Po 3.85 V
- fast charging: PD 20 W
- max.input power: 18 W
- type of input interface: 1× USB-C
- charging time: 2 hours
- max.output power: 20 W
- type of output interface: 1× USB-C
- cable included: USB-C/USB-C
- LED charging indicator
- LED battery status indicator
- auto ON/OFF
- passthrough
- material: ABS plastic
- colour: black
- weight: 118 g
- dimensions: 103 × 68 × 13 mm



8 592920 131695
B0545B 1/-/-/28
 16 13 054 500 WI 521

- battery capacity: 10 000 mAh/38.5 Wh
- battery type: Li-Po 3.85 V
- fast charging: PD 20 W + SCP 22.5 W + Dash + War
- max.input power: 18 W
- type of input interface: 1× USB-C
- charging time: 4 hours (with QC)
- max.output power: 22.5 W
- type of output interface: 1× USB-A, 1× USB-C
- cable included: USB-A/USB-C, data
- LED charging indicator
- LED battery status indicator
- auto ON/OFF
- passthrough
- material: ABS plastic
- colour: black
- weight: 186 g
- dimensions: 109 × 68 × 20 mm



8 592920 119853
B0543B 1/-/-/28
 16 13 054 300 WI 1023D

- battery capacity: 10 000 mAh/37 Wh
- battery type: Li-Po 3.7 V
- fast charging: PD 20 W + SCP 22.5 W + Dash + War
- max.input power: 18 W
- type of input interface: 1× micro USB, 1× USB-C
- charging time: 4 hours
- max.output power: 22.5 W
- type of output interface: 2× USB-A, 1× USB-C
- cable included: USB-A/USB-C, data
- LED charging indicator
- LED battery status indicator
- auto ON/OFF
- passthrough
- material: ABS plastic
- colour: black
- weight: 233 g
- dimensions: 143 × 68 × 16 mm



8 592920 124772
B0531B 1/-/-/20
 16 13 053 100 BETAQ 10

- battery capacity: 20 000 mAh/74 Wh
- battery type: Li-Po 3.7 V
- fast charging: PD 20 W + SCP 22.5 W + Dash + War
- max.input power: 18 W
- type of input interface: 1× micro USB, 1× USB-C
- charging time: 7 hours (with QC)
- max.output power: 22.5 W
- type of output interface: 2× USB-A, 1× USB-C
- cable included: USB-A/USB-C, data
- LED charging indicator
- LED battery status indicator
- auto ON/OFF
- passthrough
- material: ABS plastic
- colour: black
- weight: 409 g
- dimensions: 143 × 68 × 28 mm



8 592920 124796
B0532B 1/-/-/12
 16 13 053 200 BETAQ 20

- battery capacity: 10 000 mAh/37 Wh
- battery type: Li-Po 3.7 V
- fast charging: no
- max.input power: 10 W
- type of input interface: micro USB
- charging time: 6 hours
- max.output power: 10,5 W
- type of output interface: 2× USB-A
- cable included: micro USB, USB-C, data
- LED charging indicator
- LED battery status indicator
- auto ON/OFF
- passthrough
- material: ABS plastic
- colour: black
- weight: 220 g
- dimensions: 138 × 68 × 16 mm



B0526B 1/-/-/28
16 13 052 600 ALPHA 10S

- battery capacity: 20 000 mAh/74 Wh
- battery type: Li-Po 3.7 V
- fast charging: no
- max.input power: 10 W
- type of input interface: 1× micro USB, 1× USB-C
- charging time: 12 hours
- max.output power: 10 W
- type of output interface: 2× USB-A, 1× USB-C
- cable included: USB-A/USB-C, data
- LED charging indicator
- LED battery status indicator
- auto ON/OFF
- passthrough
- material: ABS plastic
- colour: black
- weight: 412 g
- dimensions: 142 × 67 × 27 mm



B0527B 1/-/-/24
16 13 052 700 ALPHA2 20

USB chargers

- faster charging than via USB port on laptop
- USB adapters for standard socket or car with 1–4 USB ports
- smart functions for fast charging and device protection
- minimum energy losses during transfer
- BASIC–Economy line of high-quality chargers
- SMART–Higher current allows charging multiple devices at once
- QUICK–Quick charging for devices with Qualcomm processors

max. output 1× USB: 5 V/2.1 A/10.5 W = max. output total: 5 V/3.1 A/15.5 W = input voltage: 100–240 V~ 50/60 Hz = charging: smart = number of USB outputs: 2 = protection against overload, overvoltage and short circuit = designed for: smartphone, tablet = dimensions: 80 × 39 × 27 mm = packaging: 1 pc, blister



V0125 1/-/4/36
17 04 012 500 V0125

max. output 1× USB: QC 3.0-2.0 (5–12 V/1.5–3.0 A/18 W) = max. output total: QC 3.0-2.0 (5–12 V/1.5–3.0 A/18 W) = input voltage: 100–240 V~ 50/60 Hz = charging: quick = number of USB outputs: 1 = protection against overload, overvoltage and short circuit = designed for: smartphone, tablet = dimensions: 87 × 44 × 25 mm = packaging: 1 pc, blister



V0123 1/-/-/50
17 04 012 300 V0123

max. output 1× USB: 5 V/1 A/5 W = max. output total: 5 V/1 A/5 W = input voltage: 100–240 V~ 50/60 Hz = charging: basic = number of USB outputs: 1 = protection against overload, overvoltage and short circuit = designed for: smartphone = dimensions: 78 × 34 × 21 mm = packaging: 1 pc, blister



V0122 1/-/25/50
17 04 012 200 V0122

max. output 1× USB: QC 3.0–2.0, PD (5–12 V/1,5–3,0 A/18 W) = max. output total: QC 3.0–2.0, PD (5–12 V/1,5–3,0 A/30 W) = input voltage: 100–240 V~ 50/60 Hz = charging: quick = number of USB outputs: 2 = protection against overload, overvoltage and short circuit = designed for: smartphone, tablet = dimensions: 91 × 54 × 27 mm = packaging: 1 pc, blister



V0120 1/-/-/56
17 04 012 000 V0120

max. output 1× USB: 5 V/2.1 A/10.5 W = max. output total: 5 V/2.1 A/10.5 W = input voltage: 12–24 V DC = charging: basic = number of USB outputs: 1 = protection against overload, overvoltage and short circuit = designed for: smartphone, tablet = LED indicators = power supply type: micro USB cable 1 m, USB-C reduction in packaging = dimensions: 65 × 28 × 28 mm = packaging: 1 pc, blister



V0219 1/-/-/25
17 04 021 900 V0219

Universal adaptors

- EMOS adapters come with a set of replaceable connectors
- SMPS suitable for light-current devices (torches, antennas)

max. output 1× USB: 5 V/2.0 A/10 W = max. output total: 5 V/2.0 A/10 W = input voltage: 100–240 V~ 50/60 Hz = number of USB outputs: 1 = protection against overload, overvoltage and short circuit = designed for: universal = LED indicators = output voltage: 3 V, 4.5 V, 5 V, 6 V, 7.5 V, 9 V, 12 V = output current: max. 2 250 mA = size of the connector: B 3.5/15; C 3.0×1.0/10; D 5.0×2.1/12; G 5.5×2.5/10; H 3.5×1.35/10; I 4×1.7/10; S 2.35×0.75/8.7 = power supply type: cable + set of DC connectors + USB out = dimensions: 50 × 80 × 32 mm = packaging: 1 pc, blister



N3113 1/-/-/24
17 03 225 021 N3113



www.emos.eu

Order Code
Item Number

Packaging
Type

max. output 1× USB: 5 V/2.0 A/10 W = max. output total: 5 V/2.0 A/10 W = input voltage: 100–240 V~ 50/60 Hz = number of USB outputs: 1 = protection against overload, overvoltage and short circuit = designed for: universal = LED indicators = output voltage: 3 V, 4.5 V, 5 V, 6 V, 7.5 V, 9 V, 12 V = output current: max. 1 500 mA = size of the connector: B 3.5/15; C 3.0×1.0/10; D 5.0×2.1/12; G 5.5×2.5/10; H 3.5×1.35/10; I 4×1.7/10; S 2.35×0.75/8.7 = power supply type: cable + set of DC connectors + USB out = dimensions: 50 × 80 × 32 mm = packaging: 1 pc, blister



N3112 1/-/-/24
17 03 150 021 N3112

max. output 1× USB: 5 V/2.0 A/10 W = max. output total: 5 V/2.0 A/10 W = input voltage: 100–240 V~ 50/60 Hz = number of USB outputs: 1 = protection against overload, overvoltage and short circuit = designed for: universal = LED indicators = output voltage: 3 V, 4.5 V, 5 V, 6 V, 7.5 V, 9 V, 12 V = output current: max. 1 000 mA = size of the connector: B 3.5/15; C 3.0×1.0/10; D 5.0×2.1/12; G 5.5×2.5/10; H 3.5×1.35/10; I 4×1.7/10; S 2.35×0.75/8.7 = power supply type: cable + set of DC connectors + USB out = dimensions: 50 × 80 × 32 mm = packaging: 1 pc, blister



N3111 1/-/-/24
17 03 100 021 N3111

input voltage: 100–240 V~ 50/60 Hz = protection against overload, overvoltage and short circuit = designed for: universal = LED indicators = output voltage: 3 V, 4.5 V, 5 V, 6 V, 7.5 V, 9 V, 12 V = output current: max. 600 mA = size of the connector: B 3.5/15; C 3.0×1.0/10; D 5.0×2.1/12; G 5.5×2.5/10; H 3.5×1.35/10; I 4×1.7/10; S 2.35×0.75/8.7 = power supply type: cable + set of DC connectors = dimensions: 36 × 66 × 30 mm = packaging: 1 pc, blister



N3110 1/-/-/20
17 03 060 021 N3110

Car battery chargers, testers

- for charging car batteries and other accumulators
- with voltage of 6 or 12 V and capacity of 1.2–120 Ah
- diagnoses type of connected battery, auto-selects programme
- adapts charging speed and intensity to ambient temperature
- non-stop connection extends battery life in rarely-used cars
- restores slightly damaged accumulators to original condition
- with short-circuit and reversed polarity protection

designed for: cars, motorcycles, backup batteries, lead acid battery WET (acid), MF (Maintenance Free), VRLA, AGM and GEL = charging: 6 V (1.2 Ah–14 Ah), 12 V (1.2 Ah–120 Ah) = charging cable: 1.8 m is terminated by clips = desulfation mode = sustaining mode = cold weather program = protection against short circuit and reverse polarity = entrance: 220–240 V AC/50 Hz/600 mA = IP rating: IP65 = packaging: 1 pc, box



N1014 1/-/-/12
16 06 025 000 EE04A



www.emos.eu

Order Code
Item Number

Packaging
Type

designed for: cars, motorbikes, backup accumulator, SLA battery WET (acid), MF (maintenance-free), VRLA, AGM + GEL and 12.8 V LiFePO4 = charging: 6 V (1.2 Ah-30 Ah), 12 V (1.2 Ah-30 Ah); 12.8 V LiFePO4 (2 Ah-15 Ah) = charging cable: 1.8 m is terminated by clips = disulfation mode = sustaining mode = protection against short circuit and reverse polarity = entrance: 220-240 V AC/50 Hz/300 mA = IP rating: IP65 (charger cover) = packaging: 1 pc, box

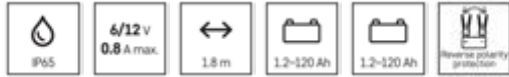

N1015	1/-/-/20
16 08 000 001	E-CC008A

Portable Lighting



GP

Flashlights

GP Discovery



- quality all-metal GP torches for daily use
- powerful yet efficient LED chips (CREE LED in some models)
- compatible with alkaline and rechargeable batteries
- anti-scratch surface finish
- water-resistance up to IPX7 (CR41 usable briefly underwater)

- source of light: CREE SMD LED
- maximal light output: 650 lm
- maximal beam distance: 135 m
- number of lighting modes: 4
- runtime: 5.5-40 hrs
- focus
- impact resistance: 1 m
- waterproof: IPX7
- rechargeable

- battery: Li-Ion
- battery type: 18650/3,7 V/2 550 mAh
- batteries included
- recharge time: 3 hrs
- power connector type: micro USB
- features: textile loop
- dimensions: 33 × 136 mm
- weight: 179 g
- packaging: 1 pc, small paper box



P8511 1/-/-12
14 51 704 100 CR41

- source of light: CREE SMD LED
- maximal light output: 300 lm
- maximal beam distance: 100 m
- number of lighting modes: 3
- runtime: 4.5-15 hrs
- focus
- impact resistance: 1 m
- waterproof: IPX4
- rechargeable: no

- battery: 3× AAA
- battery type: LR03 (1.5 V)
- batteries included
- features: textile loop
- dimensions: 32 × 108 mm
- weight: 120 g
- packaging: 1 pc, small paper box



P8506 1/-/-12
14 51 703 200 C32



www.emos.eu

Order Code
Item Number

Packaging
Type

- source of light: COB LED + CREE SMD LED
- maximal light output: 180 lm
- maximal beam distance: 100 m
- number of lighting modes: 3
- runtime: 2-20 hrs
- focus
- impact resistance: 1 m
- waterproof: IPX4
- rechargeable: no
- battery: 2× AA
- battery type: LR6 (1,5 V)
- batteries included
- features: magnet, metal clip
- dimensions: 26 × 165 mm
- weight: 128 g
- packaging: 1 pc, small paper box



P8504 1/-/-/12
14 51 703 300 C33

- source of light: 1× LED
- maximal light output: 20 lm
- maximal beam distance: 25 m
- number of lighting modes: 1
- runtime: 3 hrs
- impact resistance: 1 m
- waterproof: IPX4
- rechargeable: no
- battery: 1× AAA
- battery type: LR03 (1.5 V)
- batteries included
- features: metal snap-hook
- dimensions: 18 × 89 mm
- weight: 37 g
- packaging: 1 pc, small paper box



P8502 1/-/12/72
14 51 701 200 CK12

- source of light: CREE SMD LED
- maximal light output: 100 lm
- maximal beam distance: 75 m
- number of lighting modes: 2
- runtime: 2-7 hours
- impact resistance: 1 m
- waterproof: IPX4
- rechargeable: no
- battery: 1× AA
- battery type: LR6 (1,5 V)
- batteries included
- features: textile loop
- dimensions: 22.5 × 95 mm
- weight: 64 g
- packaging: 1 pc, small paper box



P8507 1/-/-/12
14 51 703 110 C31X

- source of light: COB LED + CREE LED
- maximal light output: 550 lm
- maximal beam distance: 110 m
- number of lighting modes: 4
- runtime: 20 hrs
- impact resistance: 1 m
- waterproof: IPX4
- rechargeable: no
- battery: 3× AA
- battery type: LR6 (1,5 V)
- batteries included
- features: magnet, metal clip
- dimensions: 27.5 × 193 mm
- weight: 217 g
- packaging: 1 pc, small paper box



P8508 1/-/-/12
14 51 703 402 C34

GP Everyday



- lightweight and compact flashlights for everyday use
- ready-made fixing for any wrist strap
- focus on the head of the flashlight for precise light focusing
- made of durable plastic

- source of light: LED
- maximal light output: 50 lm
- maximal beam distance: 30 m
- number of lighting modes: 1
- runtime: 24 hours
- focus: yes (screwable)
- impact resistance: 1 m
- waterproof: IPX4
- rechargeable: no
- battery: 1× AA 1.5 V
- battery type: LR6 (1,5 V)
- batteries included
- features: hole for strap
- dimensions: 36 × 126 mm
- weight: 62 g
- packaging: 1 pc, blister



P8105 1/-/-12
14 51 710 500 C105

- source of light: LED
- maximal light output: 70 lm
- maximal beam distance: 45 m
- number of lighting modes: 1
- runtime: 24 hours
- focus: yes (screwable)
- impact resistance: 1 m
- waterproof: IPX4
- rechargeable: no
- battery: 2× AA
- battery type: LR6 (1,5 V)
- batteries included
- features: hole for strap
- dimensions: 42 × 166 mm
- weight: 106 g
- packaging: 1 pc, blister



P8107 1/-/-12
14 51 710 700 C107

GP

Headlights

GP Xplor



- ultra-light trail running headlamps
- natural part of sports and professional equipment
- quality CREE LED chips for high luminous flux: 300–500 lm
- water-resistant (IPX6) and impact-resistant (from up to 1 m)
- AAA powered or as a rechargeable version
- compatible with single-use and rechargeable batteries
- Button Lock – protects against switching on accidentally

- source of light: 3× CREE SMD LED
- maximal light output: 500 lm
- maximal beam distance: 85 m
- number of lighting modes: 10
- runtime: 60 s – 100 hrs
- focus: no
- reflective head strap
- impact resistance: 1 m
- waterproof: IPX6

- charging
- power supply: Li-Po
- battery type: Li-Po 1 600 mAh
- batteries included
- special function: button lock mode
- accessories: USB-C cable
- dimensions: 56 × 38 × 39 mm
- weight: 59.5 g
- packaging: 1 pc, small paper box



P8567 1/-/-/10
14 51 085 670 PHR17

- source of light: 2× CREE SMD LED
- maximal light output: 300 lm
- maximal beam distance: 50 m
- number of lighting modes: 9
- runtime: 60 s – 45 hrs
- focus: no
- reflective head strap
- impact resistance: 1 m
- waterproof: IPX6

- charging
- power supply: Li-Po
- battery type: Li-Po 800 mAh
- batteries included
- special function: button lock mode
- accessories: USB-C cable
- dimensions: 56 × 38 × 34 mm
- weight: 44 g
- packaging: 1 pc, small paper box



P8566 1/-/-/10
14 51 085 660 PHR16

- source of light: 2× Osram SMD LED
- maximal light output: 1 200 lm
- maximal beam distance: 110 m
- number of lighting modes: 11
- runtime: 2–100 hrs
- focus: no
- reflective head strap
- impact resistance: 1.5 m
- waterproof: IPX8

- charging
- power supply: Li-ion/2× CR123A
- battery type: 18650/3,7 V/2 550 mAh
- batteries included
- special function: button lock mode
- accessories: USB-A=>USB-C cable 30 cm
- dimensions: 91.5 × 39 × 51 mm
- weight: 90 g/151 g
- packaging: 1 pc, small paper box



P8569 1/-/-/10
14 51 701 900 PHR19

GP Discovery



- quality all-metal GP headlamps for daily use
- powerful yet efficient LED chips (CREE LED in some models)
- compatible with alkaline and rechargeable batteries
- anti-scratch surface finish
- water-resistance up to IPX7 (CR41 usable briefly underwater)

- source of light: CREE SMD LED
- maximal light output: 600 lm
- maximal beam distance: 130 m
- number of lighting modes: 5
- runtime: 40 s – 60 hrs
- focus: no
- reflective head strap: no
- impact resistance: 1 m
- waterproof: IPX4

- charging
- power supply: Li-Ion
- battery type: 18650/3,7 V/2 550 mAh
- batteries included
- special function: button lock mode
- accessories: micro USB cable
- dimensions: 106 × 27 × 27 mm
- weight: 153 g
- packaging: 1 pc, small paper box



P8555 1/-/-/10
14 51 703 500 CHR35

- source of light: CREE SMD LED
- maximal light output: 300 lm
- maximal beam distance: 157 m
- number of lighting modes: 4
- runtime: 5–69 hrs
- focus: no
- reflective head strap: no
- impact resistance: 1 m
- waterproof: IPX6

- charging
- power supply: 3× AAA
- battery type: HR03 (1.5 V)
- batteries included
- special function: auto-dimming mode, button lock mode
- accessories: micro USB cable
- dimensions: 34 × 46 × 56 mm
- weight: 110 g
- packaging: 1 pc, small paper box



P8572 1/-/6/24
14 51 704 101 CHR41

- source of light: CREE SMD LED
- maximal light output: 300 lm
- maximal beam distance: 157 m
- number of lighting modes: 4
- runtime: 5–69 hrs
- focus: no
- reflective head strap: no
- impact resistance: 1 m
- waterproof: IPX6

- charging: no
- power supply: 3× AAA
- battery type: LR03 (1.5 V)
- batteries included
- special function: touchless dimming
- dimensions: 34 × 46 × 56 mm
- weight: 110 g
- packaging: 1 pc, small paper box



P8571 1/-/6/24
14 51 704 600 CH46

- source of light: 4× LED
- maximal light output: 40 lm
- maximal beam distance: 8 m
- number of lighting modes: 3
- runtime: 2–6 hrs
- focus: no
- reflective head strap: no
- impact resistance: 1 m
- waterproof: no

- charging: no
- power supply: 2× CR2025
- batteries included
- dimensions: 37 × 36 × 20 mm
- weight: 31 g
- packaging: 1 pc, blister



P8551P 1/-/-/12
14 51 703 102 CH31



www.emos.eu

Order Code
Item Number

Packaging
Type

- source of light: 2× SMD LED
- maximal light output: 110 lm
- maximal beam distance: 40 m
- number of lighting modes: 4
- runtime: 15 hours
- focus: no
- reflective head strap: no
- impact resistance: 1 m
- waterproof: IP43

- charging: no
- power supply: 3× AAA
- battery type: LR03 (1.5 V)
- batteries included
- dimensions: 59 × 46 × 34 mm
- weight: 29 g/65 g
- packaging: 1 pc, small paper box



P8582 1/-/-/10
14 51 704 200 CH42

- source of light: 2× SMD LED + LED
- maximal light output: 150 lm
- maximal beam distance: 45 m
- number of lighting modes: 5
- runtime: 36 hours
- focus: no
- reflective head strap: no
- impact resistance: 1 m
- waterproof: IPX4

- charging: no
- power supply: 3× AAA
- battery type: LR03 (1.5 V)
- batteries included
- dimensions: 61 × 47 × 37 mm
- weight: 42 g/78 g
- packaging: 1 pc, small paper box



P8583 1/-/-/10
14 51 704 300 CH43

- source of light: 2× SMD LED
- maximal light output: 300 lm
- maximal beam distance: 60 m
- number of lighting modes: 6
- runtime: 36 hours
- focus: no
- reflective head strap: no
- impact resistance: 1 m
- waterproof: IPX4

- charging: no
- power supply: 3× AAA
- battery type: LR03 (1.5 V)
- batteries included
- special function: touchless control
- dimensions: 61 × 47 × 37 mm
- weight: 42 g/78 g
- packaging: 1 pc, small paper box



P8584 1/-/-/10
14 51 704 400 CH44

- source of light: 2× CREE SMD LED
- maximal light output: 280 lm
- maximal beam distance: 90 m
- number of lighting modes: 6
- runtime: 25 hours
- focus: no
- reflective head strap: no
- impact resistance: 5 m
- waterproof: IPX5

- charging: no
- power supply: 3× AAA
- battery type: LR03 (1.5 V)
- batteries included
- dimensions: 66 × 49 × 37 mm
- weight: 95 g
- packaging: 1 pc, small paper box



P8573 1/-/-/10
14 51 705 300 CHW53

- source of light: 2× CREE SMD LED
- maximal light output: 375 lm
- maximal beam distance: 110 m
- number of lighting modes: 4
- runtime: 26 hours
- focus: no
- reflective head strap: no
- impact resistance: 5 m
- waterproof: IPX5

- charging: no
- power supply: 3× AAA
- battery type: LR03 (1.5 V)
- batteries included
- special function: touchless dimming
- dimensions: 66 × 49 × 37 mm
- weight: 62 g/98 g
- packaging: 1 pc, small paper box



P8574 1/-/-/10
14 51 705 400 CHW54

EMOS

LED Metal Flashlights

ULTIBRIGHT Flashlights

ULTIBRIGHT

- ULTIBRIGHT premium flashlights – compact, durable and reliable
- distinguished by an elegant red ring
- designer flashlights made of durable metal
- reliably withstand impact from falling onto a hard surface
- extraordinary luminous flux and beam distance thanks to a brand-name CREE LED chip
- easy to keep on hand thanks to their compact size practical clip and reliable strap

- source of light: CREE LED
- maximal light output: 1 200 lm
- maximal beam distance: 280 m
- number of lighting modes: 3
- runtime: 3–11 hrs
- focus: yes (screwable)
- impact resistance
- waterproof: yes (IP65)
- rechargeable

- battery: Li-Ion 26650
- battery type: 5 000 mAh/3.7 V
- batteries included
- recharge time: 11.5 hrs
- power connector type: USB C
- features: hand strap
- dimensions: 157 × 40 × 40 mm
- weight: 198 g (without battery)
- packaging: 1 pc, box



P3190 1/-/4/16
14 50 000 340 P3190

- source of light: CREE LED
- maximal light output: 600 lm
- maximal beam distance: 230 m
- number of lighting modes: 3
- runtime: 3.5–12 hrs
- focus: yes (screwable)
- impact resistance
- waterproof: yes (IP65)
- rechargeable

- battery: Li-Ion 18650
- battery type: 2 600 mAh/3.7 V
- batteries included
- recharge time: 4.5 hrs
- power connector type: USB C
- features: hand strap
- dimensions: 151 × 34 × 34 mm
- weight: 189 g
- packaging: 1 pc, box



P3180 1/-/4/16
14 50 000 330 P3180

- source of light: CREE LED
- maximal light output: 340 lm
- maximal beam distance: 200 m
- number of lighting modes: 2
- runtime: 3–5.5 hrs
- focus: yes (screwable)
- impact resistance
- waterproof: yes (IP65)
- rechargeable: no

- battery: 3× AAA
- battery type: LR03 (1.5 V)
- batteries included: no
- features: clip, loop
- dimensions: 124 × 34 × 34 mm
- weight: 112 g
- packaging: 1 pc, box



P3170 1/-/4/16
14 40 013 123 P3170



www.emos.eu

Order Code
Item Number

Packaging
Type

- source of light: CREE LED
- maximal light output: 170 lm
- maximal beam distance: 100 m
- number of lighting modes: 1
- runtime: 2.5 hrs
- impact resistance
- waterproof: yes (IP65)
- rechargeable: no
- battery: 1× AA

- battery type: LR6 (1,5 V)
- batteries included: no
- features: clip, loop
- dimensions: 101 × 22 × 22 mm
- weight: 47 g
- packaging: 1 pc, box



P3160 1/-/8/32
14 40 011 203 P3160

- source of light: CREE LED
- maximal light output: 100 lm
- maximal beam distance: 65 m
- number of lighting modes: 1
- runtime: 3 hrs
- impact resistance
- waterproof: yes (IP65)
- rechargeable: no
- battery: 1× AAA

- battery type: LR03 (1.5 V)
- batteries included: no
- features: clip, loop
- dimensions: 98 × 16 × 16 mm
- weight: 32 g
- packaging: 1 pc, box



P3150 1/-/8/32
14 40 011 100 P3150

EMOS Flashlights

- quality aluminium casing ensures lightness and durability
- battery-powered and rechargeable
- run time up to 35 hours
- maximal beam distance up to 230 m

- source of light: LED
- maximal light output: 600 lm
- maximal beam distance: 230 m
- number of lighting modes: 3
- runtime: 4–8 hrs
- focus
- impact resistance
- waterproof: yes (IP44)
- rechargeable

- battery: Li-Ion 18650 or 3× AAA
- battery type: 2 000 mAh/3.7 V or LR03 (1.5 V)
- batteries included
- recharge time: 4 hrs
- power connector type: USB C
- features: hand strap
- dimensions: 183 × 41 × 41 mm
- weight: 230 g
- packaging: 1 pc, box



P3116 1/-/10/20
14 40 011 500 P3116

- source of light: LED
- maximal light output: 500 lm
- maximal beam distance: 160 m
- number of lighting modes: 3
- runtime: 5.5–22 hrs
- focus
- impact resistance
- waterproof: yes (IP44)
- rechargeable: no

- battery: 4× AAA
- battery type: LR03 (1.5 V)
- batteries included: no
- features: hand strap
- dimensions: 128 × 37 × 37 mm
- weight: 129 g
- packaging: 1 pc, paper blister



P3115 1/-/6/24
14 40 014 100 P3115



- source of light: LED
- maximal light output: 330 lm
- maximal beam distance: 120 m
- number of lighting modes: 3
- runtime: 10-27 hrs
- focus
- impact resistance
- waterproof: yes (IP44)
- rechargeable: no

- battery: 3× AAA
- battery type: LR03 (1.5 V)
- batteries included: no
- features: hand strap
- dimensions: 128 × 37 × 37 mm
- weight: 121 g
- packaging: 1 pc, paper blister



P3114 1/-/6/24
14 40 013 125 P3114

- source of light: LED
- maximal light output: 120 lm
- maximal beam distance: 90 m
- number of lighting modes: 1
- runtime: 7 hrs
- focus
- impact resistance
- waterproof: yes (IP44)
- rechargeable: no

- battery: 2× AAA
- battery type: LR03 (1.5 V)
- batteries included: no
- features: hand strap
- dimensions: 131 × 21 × 21 mm
- weight: 48 g
- packaging: 1 pc, paper blister



P3113 1/-/6/30
14 40 012 111 P3113

- source of light: COB LED + LED
- maximal light output: 270 lm
- maximal beam distance: 145 m
- number of lighting modes: 5
- runtime: 4-15 hrs
- impact resistance
- waterproof: yes (IP44)
- rechargeable: no
- battery: 2× AA

- battery type: LR6 (1.5 V)
- batteries included: no
- features: clip, 1× magnet
- dimensions: 171 × 30 × 30 mm
- weight: 108 g
- packaging: 1 pc, paper blister



P3112 1/-/6/24
14 40 022 200 P3112

- source of light: LED + COB LED
- maximal light output: 230 lm
- maximal beam distance: 210 m
- number of lighting modes: 3
- runtime: 1.5-6 hrs
- focus
- impact resistance: no
- waterproof: no
- rechargeable: no

- battery: 3× AAA
- battery type: LR03 (1.5 V)
- batteries included: no
- features: loop, 1× magnet
- dimensions: 150 × 37 × 37 mm
- weight: 158 g
- packaging: 1 pc, blister



P3111 1/-/6/18
14 40 813 170 E-1631-1

- source of light: COB LED
- maximal light output: 120 lm
- maximal beam distance: 20 m
- number of lighting modes: 1
- runtime: 60 hrs
- impact resistance
- waterproof: yes (IP43)
- rechargeable: no
- battery: 3× AAA

- battery type: LR03 (1.5 V)
- batteries included: no
- features: hand strap
- dimensions: 102 × 28 × 28 mm
- packaging: 1 pc, blister



P4704 1/-/12/60
14 40 813 150 E-2217



www.emos.eu

Order Code
Item Number

Packaging
Type

- source of light: COB LED
- maximal light output: 100 lm
- maximal beam distance: 15 m
- number of lighting modes: 1
- runtime: 35 hrs
- impact resistance
- waterproof: no
- rechargeable: no
- battery: 3× AAA
- battery type: LR03 (1.5 V)
- batteries included: no
- features: hand strap
- dimensions: 85 × 25 × 25 mm
- weight: 34 g
- packaging: 1 pc, blister



P3894 1/-/12/60
14 40 813 110 E3221

EMOS

LED Plastic Flashlights

- efficient, yet inexpensive light source
- compact and light
- for battery types: AA, AAA or D
- run time up to 140 hours
- maximal beam distance up to 305 m

- source of light: SMD LED + LED
- maximal light output: 215 lm
- maximal beam distance: 305 m
- number of lighting modes: 5
- runtime: 90 hrs
- impact resistance: no
- waterproof: no
- rechargeable: no
- battery: 3× AA
- battery type: LR6 (1,5 V)
- batteries included: no
- dimensions: 80 × 130 × 150 mm
- weight: 210 g
- packaging: 1 pc, box



P4008 1/-/8/16
14 47 013 200 P4008

- source of light: LED
- maximal light output: 75 lm
- maximal beam distance: 130 m
- number of lighting modes: 1
- runtime: 72 hrs
- focus
- impact resistance
- waterproof: yes (IP43)
- rechargeable: no
- battery: 3× AAA
- battery type: LR03 (1.5 V)
- batteries included: no
- features: hand strap
- dimensions: 120 × 35 × 35 mm
- weight: 83 g
- packaging: 1 pc, paper blister



P4702 1/-/10/50
14 40 013 114 E-1512



- source of light: LED
- maximal light output: 55 lm
- maximal beam distance: 125 m
- number of lighting modes: 1
- runtime: 16 hrs
- impact resistance
- waterproof: no
- rechargeable: no
- battery: 2× AA

- battery type: LR6 (1,5 V)
- batteries included: no
- features: hand strap
- dimensions: 155 × 45 × 45 mm
- weight: 73 g
- packaging: 1 pc, paper blister



P3210
14 40 004 904

1/-/6/24
E-5134

- source of light: LED
- maximal light output: 20 lm
- maximal beam distance: 35 m
- number of lighting modes: 1
- runtime: 30 hrs
- impact resistance
- waterproof: yes (IP43)
- rechargeable: no
- battery: 2× AA

- battery type: LR6 (1,5 V)
- batteries included: no
- features: hand strap
- dimensions: 162 × 43 × 43 mm
- weight: 85 g
- packaging: 1 pc, paper blister



P3861
14 40 032 202

1/-/-/24
HL-R0217-2AA

- source of light: LED
- maximal light output: 20 lm
- maximal beam distance: 75 m
- number of lighting modes: 1
- runtime: 140 hrs
- impact resistance: no
- waterproof: yes (IP43)
- rechargeable: no
- battery: 2× D

- battery type: LR20 (1.5 V)
- batteries included: no
- features: hand strap
- dimensions: 190 × 68 × 68 mm
- weight: 216 g
- packaging: 1 pc, paper blister



P3862
14 40 032 400

1/-/-/10
HL-R0217-2D

- source of light: COB LED
- maximal light output: 300 lm
- maximal beam distance: 15 m
- number of lighting modes: 1
- runtime: 5 hrs
- impact resistance
- rechargeable: no
- battery: 3× AA
- battery type: LR6 (1,5 V)

- batteries included: no
- features: 1× hook, 1× magnet
- dimensions: 85 × 130 × 85mm
- packaging: 1 pc, box



P4006
14 47 003 100

1/-/-/16
E-6020

- source of light: LED
- maximal light output: 10 lm
- maximal beam distance: 7 m
- number of lighting modes: 2
- runtime: 25–35 hrs
- rechargeable: no
- battery: 1× AAA
- battery type: LR03 (1.5 V)
- batteries included: no

- features: clip
- dimensions: 259 × 20 × 25 mm
- weight: 30 g
- packaging: 1 pc, blister



P3400
14 40 211 100

1/-/10/20
P3400



www.emos.eu

Order Code
Item Number

Packaging
Type

- source of light: LED + COB LED
- maximal light output: 150 lm
- maximal beam distance: 150 m
- number of lighting modes: 4
- runtime: 2-4,5 h
- focus
- impact resistance
- waterproof: IP44
- rechargeable
- battery: Li-Ion 18650
- battery type: 1 200 mAh/3.7 V
- batteries included
- recharge time: 2 hrs
- power connector type: micro USB B
- dimensions: 130 × 35 × 35 mm
- weight: 80 g



P3213 1/-/6/24
14 40 004 907 P3213

LED Headlights

- indispensable part of outdoor gear
- selected models contains top quality CREE LED chips
- battery-powered and rechargeable models
- multiple light modes
- maximal beam distance up to 200 m
- run time up to 50 hours

- source of light: COB LED + LED
- maximal light output: 380 lm
- maximal beam distance: 30 m
- number of lighting modes: 4
- runtime: 3-12 hrs
- focus: no
- reflective head strap: no
- impact resistance
- waterproof: yes (IP43)
- charging
- power supply: Li-pol
- battery type: 1 200 mAh/3.7 V
- batteries included
- special function: hand-operated switching, quick swi
- accessories: USB-C cable
- dimensions: 300 × 3.2 × 20 mm
- weight: 73 g
- packaging: 1 pc, small paper box



P3541 1/-/6/24
14 41 292 150 P3541

- source of light: CREE LED
- maximal light output: 230 lm
- maximal beam distance: 80 m
- number of lighting modes: 4
- runtime: 3-13 hrs
- focus: no
- reflective head strap
- impact resistance
- waterproof: no
- charging
- power supply: Li-pol
- battery type: 1 200 mAh (3.7 V)
- batteries included
- special function: hand-operated switching, quick swi
- accessories: power cable
- dimensions: 61 × 37 × 31 mm
- weight: 60 g
- packaging: 1 pc, paper blister



P3534 1/-/10/40
14 41 250 920 E-943

- source of light: CREE LED + 4× SMD
- maximal light output: 110 lm
- maximal beam distance: 55 m
- number of lighting modes: 3
- runtime: 3-7 hrs
- focus: no
- reflective head strap
- impact resistance: no
- waterproof: no
- charging
- power supply: Li-pol
- battery type: 850 mAh (3.7 V)
- batteries included
- special function: quick switch ON/OFF, battery prote
- accessories: power cable
- dimensions: 47 × 31 × 54 mm
- weight: 64 g
- packaging: 1 pc, paper blister



P3535 1/-/6/36
14 41 251 900 E-HL030



www.emos.eu

Order Code
Item Number

Packaging
Type

- source of light: CREE LED + COB LED (green, red) +
- maximal light output: 330 lm
- maximal beam distance: 65 m
- number of lighting modes: 7
- runtime: 18-72 hrs
- focus: no
- reflective head strap
- impact resistance
- waterproof: yes (IP44)

- charging: no
- power supply: 3× AAA + 1× CR2032
- battery type: LR03 (1.5 V) + CR2032 (3 V)
- batteries included: 1× CR2032
- special function: quick switch ON/OFF
- accessories: helmet hooks
- dimensions: 65 × 32 × 39 mm
- weight: 80 g/115 g
- packaging: 1 pc, paper blister



P3531 1/-/6/24
14 41 233 110 E1801

- source of light: CREE LED + 2× red LED
- maximal light output: 330 lm
- maximal beam distance: 200 m
- number of lighting modes: 5
- runtime: 50-87 hrs
- focus
- reflective head strap: no
- impact resistance
- waterproof: yes (IP43)

- charging: no
- power supply: 3× AAA
- battery type: LR03 (1.5 V)
- batteries included: no
- special function: quick switch ON/OFF, focus
- dimensions: 60 × 48 × 43 mm
- weight: 70 g/105 g
- packaging: 1 pc, paper blister



P3539 1/-/6/24
14 41 341 100 P3539

- source of light: LED + COB LED (green, red)
- maximal light output: 220 lm
- maximal beam distance: 100 m
- number of lighting modes: 7
- runtime: 45-160 hrs
- focus: no
- reflective head strap
- impact resistance
- waterproof: yes (IP43)

- charging: no
- power supply: 3× AAA
- battery type: LR03 (1.5 V)
- batteries included: no
- special function: quick switch ON/OFF
- dimensions: 65 × 45 × 50 mm
- weight: 65 g/100 g
- packaging: 1 pc, paper blister



P3536 1/-/6/24
14 41 263 110 E-HL117

- source of light: COB LED (white, red)
- maximal light output: 125 lm
- maximal beam distance: 20 m
- number of lighting modes: 3
- runtime: 9-19 hrs
- focus: no
- reflective head strap: no
- impact resistance
- waterproof: yes (IP44)

- charging: no
- power supply: 3× AAA
- battery type: LR03 (1.5 V)
- batteries included: no
- special function: battery protection
- dimensions: 69 × 43 × 46 mm
- weight: 54 g/89 g
- packaging: 1 pc, paper blister



P3532 1/-/6/24
14 41 233 120 E-923

- source of light: COB LED
- maximal light output: 150 lm
- maximal beam distance: 20 m
- number of lighting modes: 3
- runtime: 8-27 hrs
- focus: no
- reflective head strap
- impact resistance
- waterproof: no

- charging: no
- power supply: 3× AAA
- battery type: LR03 (1.5 V)
- batteries included: no
- dimensions: 60 × 40 × 40 mm
- weight: 53 g/88 g
- packaging: 1 pc, paper blister



P3528 1/-/6/24
14 41 203 100 E-1450



www.emos.eu

Order Code
Item Number

Packaging
Type

- source of light: LED + 2× red LED
- maximal light output: 85 lm
- maximal beam distance: 65 m
- number of lighting modes: 4
- runtime: 50–120 hrs
- focus: no
- reflective head strap
- impact resistance
- waterproof: yes (IP43)

- charging: no
- power supply: 3× AAA
- battery type: LR03 (1.5 V)
- batteries included: no
- special function: quick switch ON/OFF
- dimensions: 58 × 38 × 44 mm
- weight: 54 g/89 g
- packaging: 1 pc, paper blister



P3521 1/-/8/32
14 41 162 100 HL-H0520

- source of light: COB LED
- maximal light output: 110 lm
- maximal beam distance: 15 m
- number of lighting modes: 3
- runtime: 20–40 hrs
- focus: no
- reflective head strap: no
- impact resistance
- waterproof: no

- charging: no
- power supply: 3× AAA
- battery type: LR03 (1.5 V)
- batteries included: no
- dimensions: 60 × 18 × 40 mm
- weight: 21 g/56 g
- packaging: 1 pc, paper blister



P3537 1/-/12/48
14 41 273 110 E-HL120

- source of light: 3× LED
- maximal light output: 12 lm
- maximal beam distance: 12 m
- number of lighting modes: 3
- runtime: 55 hrs
- focus: no
- reflective head strap
- impact resistance
- waterproof: yes (IP44)

- charging: no
- power supply: 2× CR2032
- batteries included
- weight: 47 g
- packaging: 8 pcs, display box



P3540 8/-/8/24
14 41 212 901 P3540

- source of light: COB LED + LED
- maximal light output: 500 lm
- maximal beam distance: 130 m
- number of lighting modes: 7
- runtime: 4–6.5 hrs
- focus: no
- reflective head strap
- impact resistance
- waterproof: yes (IP44)

- charging
- power supply: Li-pol
- battery type: 1 200 mAh/3.7 V
- batteries included
- special function: hand-operated switching, quick swi
- accessories: USB-C cable
- dimensions: 70 × 45 × 35 mm
- weight: 90 g
- packaging: 1 pc, small paper box



P3542 1/-/6/24
14 41 317 000 P3542

EMOS

LED Work Lights

LED Rechargeable Work Lights

- with quality SMD/COB LED chips, lights the whole workspace
- adapter for standard socket or car, some types also feature a power bank function
- adjustable body and numerous magnets and hooks for easy work
- reinforced ABS plastic – withstands most impacts and falls
- selected models are equipped with a powerbank function

- source of light: COB LED cold + COB LED warm
- maximal light output: 900 lm
- maximal beam distance: 35 m
- number of lighting modes: 16
- runtime: 3,5–12,5 h
- impact resistance
- rechargeable
- battery: Li-Ion
- battery type: 2× 2 000 mAh/3,7 V

- batteries included
- recharge time: 4.5 hrs
- power connector type: USB C
- features: magnet, rotating stand, hook
- dimensions: 125 × 45 × 95 mm
- weight: 325 g
- packaging: 1 pc, box



P4542
14 50 000 420

1/-/-/12
P4542

- source of light: COB LED
- maximal light output: 1 200 lm
- maximal beam distance: 60 m
- number of lighting modes: 3
- runtime: 3.5–6.5 hrs
- impact resistance
- waterproof: yes (IP44)
- rechargeable
- battery: Li-pol

- battery type: 2 000 mAh/3.7 V
- batteries included
- recharge time: 3 hrs
- power connector type: USB C
- features: magnet, stand, clip
- dimensions: 80 × 45 × 80 mm
- weight: 160 g
- packaging: 1 pc, box



P4543
14 50 000 430

1/-/-/12
P4543

- source of light: 2× COB LED
- maximal light output: 2 000 lm
- maximal beam distance: 70 m
- number of lighting modes: 5
- runtime: 3.5–14.5 hrs
- impact resistance
- waterproof: no
- rechargeable
- battery: Li-Ion accumulator

- battery type: 8 000 mAh/3.7 V
- batteries included
- recharge time: 7 hrs
- power connector type: USB C
- features: swivel handle, 4× magnet
- dimensions: 214 × 140 (280) × 56 mm
- weight: 818 g
- packaging: 1 pc, box



P4536
14 50 000 320

1/-/4/8
E-17172



www.emos.eu

Order Code
Item Number

Packaging
Type

- source of light: COB LED
- maximal light output: 1 000 lm
- maximal beam distance: 45 m
- number of lighting modes: 3
- runtime: 3.5-15.5 hrs
- impact resistance
- waterproof: yes (IP44)
- rechargeable
- battery: Li-Ion accumulator

- battery type: 4 400 mAh/3.7 V
- batteries included
- recharge time: 7.5 hrs
- power connector type: micro USB B
- features: swivel handle
- dimensions: 172 × 45 × 126 mm
- weight: 453 g
- packaging: 1 pc, box



P4533 1/-/-/10
14 50 000 300 E-5145



- source of light: COB LED
- maximal light output: 600 lm
- maximal beam distance: 35 m
- number of lighting modes: 2
- runtime: 2.5-3.5 hrs
- impact resistance
- waterproof: yes (IP44)
- rechargeable
- battery: Li-Ion accumulator

- battery type: 3 000 mAh/3.7 V
- batteries included
- recharge time: 3.5 hrs
- power connector type: micro USB B
- features: swivel handle
- dimensions: 172 × 45 × 126 mm
- weight: 436 g
- packaging: 1 pc, box



P4534 1/-/-/10
14 50 000 310 E1204



- source of light: COB LED
- maximal light output: 1 000 lm
- maximal beam distance: 40 m
- number of lighting modes: 3
- runtime: 3-17 hrs
- impact resistance
- waterproof: yes (IP44)
- rechargeable
- battery: Li-Ion

- battery type: 2 200 mAh/3.7 V
- batteries included
- recharge time: 3 hrs
- power connector type: USB C
- features: magnet, stand, clip
- dimensions: 104 × 39 × 94 mm
- packaging: 1 pc, box



P4539 1/-/-/10
14 50 000 390 P4539



- source of light: COB LED + SMD LED
- maximal light output: 750 lm
- maximal beam distance: 35 m
- number of lighting modes: 6
- runtime: 2-13 h
- impact resistance
- waterproof: yes (IP44)
- rechargeable
- battery: Li-Ion

- battery type: 1 800 mAh/3.7 V
- batteries included
- recharge time: 2,5 h
- power connector type: USB C
- features: rotating reflector, magnet, hook
- dimensions: 28 × 35 × 147/285 mm
- weight: 118 g
- packaging: 1 pc, box



P4540 1/-/-/25
14 50 000 291 P4540



- source of light: COB LED + LED
- maximal light output: 450 lm
- maximal beam distance: 100 m
- number of lighting modes: 3
- runtime: 7-16 h
- impact resistance
- waterproof: yes (IP44)
- rechargeable
- battery: Li-Ion

- battery type: 2 000 mAh/3.7 V
- batteries included
- recharge time: 3.5 hrs
- power connector type: USB C
- features: magnet, hook
- dimensions: 43 × 43 × 197 mm
- weight: 190 g
- packaging: 1 pc, box



P4541 1/-/4/12
14 50 000 292 P4541





www.emos.eu

Order Code
Item Number

Packaging
Type

- source of light: COB LED + LED
- maximal light output: 470 lm
- maximal beam distance: 45 m
- number of lighting modes: 3
- runtime: 2.5-8 hrs
- impact resistance
- waterproof: no
- rechargeable
- battery: Li-Ion accumulator

- battery type: 1 800 mAh/3.7 V
- batteries included
- recharge time: 3.5 hrs
- features: swivel handle, clip, 1× hook, 2× magnet
- dimensions: 52 × 41 × 242 mm
- weight: 256 g
- packaging: 1 pc, box



P4532 1/-/-16
14 50 000 290 E-7712

- source of light: COB LED + 5× LED
- maximal light output: 500 lm
- maximal beam distance: 30 m
- number of lighting modes: 3
- runtime: 2-26 hrs
- impact resistance
- waterproof: yes (IP43)
- rechargeable
- battery: Li-Ion accumulator

- battery type: 2 000 mAh/3.7 V
- batteries included
- recharge time: 3 hrs
- power connector type: 3.0 × 1.0/12 mm
- features: swivel handle, 1× hook, 3× magnet
- dimensions: 76 × 66 × 317 mm
- weight: 537 g
- packaging: 1 pc, box



P4525 1/-/-12
14 50 000 240 E708A-COB+5

- source of light: COB LED + LED
- maximal light output: 380 lm
- maximal beam distance: 27 m
- number of lighting modes: 3
- runtime: 3.5-24 hrs
- impact resistance
- waterproof: yes (IP43)
- rechargeable
- battery: Li-Ion accumulator

- battery type: 2 500 mAh/3.7 V
- batteries included
- recharge time: 4 hrs
- power connector type: -
- features: swivel handle, 1× hook, 2× magnet
- dimensions: 56 × 50 × 240 mm
- weight: 265 g
- packaging: 1 pc, box



P4518 1/-/6/12
14 50 000 180 E709A-COB3W+6

- source of light: 2× COB LED + LED
- maximal light output: 670 lm
- maximal beam distance: 40 m
- number of lighting modes: 3
- runtime: 2-10 hrs
- impact resistance: no
- waterproof: no
- rechargeable
- battery: Li-Ion accumulator

- battery type: 2 200 mAh/3.7 V
- batteries included
- recharge time: 3 hrs
- power connector type: USB C
- features: 1× hook, 4× magnet
- dimensions: 35 × 33 × 257 mm
- packaging: 1 pc, box



P4535 1/-/8/16
14 40 004 901 E719AU

- source of light: COB LED + LED
- maximal light output: 400 lm
- maximal beam distance: 40 m
- number of lighting modes: 3
- runtime: 3-8.5 hrs
- impact resistance
- waterproof: yes (IP43)
- rechargeable
- battery: Li-Ion accumulator

- battery type: 2 000 mAh/3.7 V
- batteries included
- recharge time: 3 hrs
- power connector type: USB C
- features: swivel handle, clip, 1× hook, 1× magnet
- dimensions: 52 × 32 × 165 mm
- weight: 196 g
- packaging: 1 pc, box



P4531 1/-/8/32
14 50 000 280 E-17191 (P4531)



www.emos.eu

Order Code
Item Number

Packaging
Type

- source of light: SMD LED + LED
- maximal light output: 700 lm
- maximal beam distance: 45 m
- number of lighting modes: 3
- runtime: 3-6 hrs
- impact resistance: no
- waterproof: no
- rechargeable
- battery: Li-Ion

- battery type: 1 200 mAh/3.7 V
- batteries included
- recharge time: 2 hrs
- power connector type: USB C
- features: 2× magnet
- dimensions: 37 × 14 × 240 mm
- weight: 100 g
- packaging: 1 pc, box



P4538

1/-/6/24

14 50 000 360

P4538

- source of light: COB LED + SMD LED
- maximal light output: 330 lm
- maximal beam distance: 45 m
- number of lighting modes: 3
- runtime: 3-7 hrs
- impact resistance
- waterproof: yes (IP43)
- rechargeable
- battery: Li-Ion

- battery type: 1 200 mAh/3.7 V
- batteries included
- recharge time: 2-4 hrs
- power connector type: USB C
- features: swivel handle, 1× clip, 1× magnet, 1× hook
- dimensions: 41 × 29 × 154 mm
- weight: 110 g
- packaging: 1 pc, box



P4537

1/-/12/24

14 50 000 350

P4537

LED Work Lights

- fitted with quality COB LED chips – lights a large workspace
- small and light – just right for the hand
- powered by AA or AAA batteries
- adjustable body and numerous magnets and hooks for easy work
- reinforced ABS plastic – withstands most impacts and falls
- long run time

- source of light: COB LED
- maximal light output: 700 lm
- maximal beam distance: 35 m
- number of lighting modes: 3
- runtime: 8-14 hrs
- impact resistance
- waterproof: yes (IP43)
- rechargeable: no
- battery: 4× AA

- battery type: LR6 (1,5 V)
- batteries included: no
- features: swivel handle
- dimensions: 145 × 105 × 35 mm
- weight: 165 g
- packaging: 1 pc, small paper box



P4113

1/-/-/14

14 40 814 200

P4113

- source of light: 2× COB LED + LED
- maximal light output: 350 lm
- maximal beam distance: 110 m
- number of lighting modes: 2
- runtime: 10-20 hrs
- waterproof: no
- rechargeable: no
- battery: 3× AA
- battery type: LR6 (1,5 V)

- batteries included: no
- features: swivel handle
- dimensions: 135 × 100 × 40 mm
- weight: 140 g
- packaging: 1 pc, small paper box



P4112

1/-/-/14

14 40 833 200

P4112



www.emos.eu

Order Code
Item Number

Packaging
Type

- source of light: COB LED
- maximal light output: 180 lm
- maximal beam distance: 45 m
- number of lighting modes: 2
- runtime: 16-24 hrs
- impact resistance
- waterproof: no
- rechargeable: no
- battery: 3× AAA
- battery type: LR03 (1.5 V)
- batteries included: no
- features: break-over handle, 1× hook, 2× magnet
- dimensions: 59 × 30 × 133 mm
- weight: 110 g
- packaging: 1 pc, blister



P3888 1/-/12/24
14 40 813 100 E-6166

LED Work Lights – 230 V

- powered from standard socket (230 V)
- long lead-in cable – 5 m
- fitted with hooks for hanging

- power source: 230 V~/50 Hz
- source of light: 20× LED 0,2 W (360 lm)
- type of cable: H05RN-F 2× 1.0 mm² rubber
- cable length: 5 m
- IP rating: IP20
- dimensions: 35 × 470 mm
- packaging: 1 pc, hanging



P4205 1/-/-/30
14 49 000 050 E-A-5LP

- power source: 230 V~/50 Hz
- source of light: bulb 60 W max. (not included)
- type of cable: H05RN-F 2× 1.0 mm² rubber
- cable length: 5 m
- IP rating: IP20
- dimensions: 110 × 390 mm
- packaging: 1 pc, hanging



P4203 1/-/-/24
14 49 000 030 DY-YJD-A-8P
(DY-YJD-A-8)



EMOS

LED Rechargeable flashlights EXPERT

- torches with high luminous efficiency and long range
- most models fitted with top quality OSRAM or CREE LED chips
- last more than 70 hours on one charging, various light modes
- pack contains classic power adapter and car adapter
- made of reinforced ABS plastic resistant to falls

- source of light: OSRAM LED
- maximal light output: 300 lm
- maximal beam distance: 370 m
- number of lighting modes: 2
- runtime: 24–30 hrs
- impact resistance: no
- waterproof: no
- rechargeable
- battery: Li-Ion accumulator

- battery type: 2 400 mAh/3.7 V
- batteries included
- recharge time: 4.5 hrs
- dimensions: 162 × 100 × 140 mm
- weight: 275 g
- packaging: 1 pc, box



P2311

1/-/-10

14 50 000 370

P2311



- source of light: OSRAM LED
- maximal light output: 750 lm
- maximal beam distance: 470 m
- number of lighting modes: 3
- runtime: 15–30 hrs
- impact resistance: no
- waterproof: no
- rechargeable
- battery: Li-Ion accumulator

- battery type: 4 000 mAh/3.7 V
- batteries included
- recharge time: 6.5 h
- power connector type: micro USB B
- dimensions: 212 × 150 × 155 mm
- weight: 527 g
- packaging: 1 pc, box



P2312

1/-/-4

14 50 000 380

P2312



- source of light: SMD LED + LED
- maximal light output: 350 lm
- maximal beam distance: 260 m
- number of lighting modes: 7
- runtime: 5–23 hrs
- impact resistance
- waterproof
- rechargeable
- battery: Li-Ion accumulator

- battery type: 2× 2 000 mAh/3.7 V
- batteries included
- recharge time: 7 hrs
- power connector type: USB C
- features: swivel handle, 1× hook, 3× magnet
- dimensions: 175 × 91 mm
- weight: 406 g
- packaging: 1 pc, box



P2313

1/-/-12

14 50 000 400

P2313



LED Bike Lights

- front (white) and rear (red) bike lights with efficient LEDs
- consume little energy despite high luminous efficiency
- water-resistant and impact-resistant from 1 m
- bike mount included

- source of light: LED/SMD LED
- maximal light output: 90 lm
- maximal beam distance: 35 m
- number of lighting modes: 3/4
- runtime: 2-5 hrs
- impact resistance: no
- waterproof: no
- rechargeable
- battery: Li-pol
- battery type: 500 mAh/3.7 V
- batteries included
- recharge time: 1 h
- power connector type: micro USB B
- dimensions: 27 × 27 × 65 mm/71 × 21 × 18 mm
- weight: 34/25 g
- packaging: 1 pc, blister



P3923 1/-/5/20
14 46 002 300 P3923

- source of light: LED (front), 3× LED (back)
- maximal light output: 150 lm
- maximal beam distance: 110 m
- number of lighting modes: 10
- runtime: 96-172 hrs
- waterproof: yes (IP43)
- rechargeable: no
- battery: front: 3× AAA, back: 2× AAA
- battery type: LR03 (1.5 V)
- batteries included: no
- dimensions: 28 × 103 mm, 30 × 65 × 40 mm
- packaging: 1 pc, blister



P3920 1/-/5/20
14 46 002 000 E-3219

- source of light: COB LED white, COB LED red
- maximal light output: 22 lm
- maximal beam distance: 7 m
- number of lighting modes: 2
- runtime: 80 hrs
- impact resistance
- waterproof: yes (IP43)
- rechargeable: no
- battery: 2× 2 CR2032
- battery type: CR2032 (3 V)
- batteries included
- dimensions: 61 × 17 × 32 mm
- packaging: 1 pc, blister



P3922 1/-/6/12
14 46 002 200 E-8068

- source of light: 2× LED white, 2× LED red
- maximal light output: 10 lm
- maximal beam distance: 13 m
- number of lighting modes: 3
- runtime: 140 hrs
- impact resistance
- waterproof: yes (IP43)
- rechargeable: no
- battery: 2× 2 CR2032
- battery type: CR2032 (3 V)
- batteries included
- dimensions: 90 × 29 × 25 mm
- packaging: 1 pc, blister



P3921 1/-/6/36
14 46 002 100 E-8075 (P3921)

EMOS

LED Night Lights

LED Battery Night Lights

- better orientation in the dark for both children and adults
- powered by AA or AAA batteries
- smart solution for places without power (attic or cabinet)
- with switch, photosensor (day/night) or PIR sensor
- very low power consumption; run time: 41–100 hours

- source of light: 8× LED 5 mm in diameter
- light color: cool white
- power source: 3× 1.5 V AA
- switch
- automatic on/off
- photosensor
- motion sensor
- time delay: 25 seconds +/- 5 seconds
- dimensions: 90 × 37 mm

▪ packaging: 1 pc, blister



P3310K

1/-/4/16

14 40 883 200

E-84001

- source of light: COB LED
- light color: cool white
- power source: 3× 1.5 V AA
- switch
- automatic on/off
- photosensor
- motion sensor
- time delay: 25 seconds +/- 5 seconds
- rotation: 360°

▪ dimensions: 85 × 96 × 119 mm
▪ packaging: 1 pc, box



P3311

1/-/-/16

14 40 004 902

E-XGCL-08MC

- source of light: 3× LED 5 mm in diameter
- light color: cool white
- power source: 3× 1.5 V AAA (included)
- switch
- motion sensor: no
- dimensions: 65 × 23 × 65 mm
- packaging: 3 pcs, blister



P3819

3/-/12/36

14 40 033 100

P3819



- source of light: SMD LED
- maximal light output: 35 lm
- maximal beam distance: 22 m
- number of lighting modes: 1
- runtime: 90 hrs
- impact resistance
- waterproof: no
- rechargeable: no
- battery: 3× AAA
- battery type: LR03 (1.5 V)
- batteries included: no
- dimensions: 108 × 148 mm
- weight: 195 g
- packaging: 1 pc, box



P3380 1/-/4/8
14 40 013 124 P3380

LED 230 V Night Lights

- better orientation in the dark for both children and adults
- very low power consumption
- socket-powered – comfortable and eco-friendly (no batteries)
- selected models with passthrough socket
- with switch, photosensor (day/night) or PIR sensor

- source of light: LED
- light color: cool white
- power source: 230 V~/50 Hz, max. 0.5 W
- automatic on/off
- photosensor
- motion sensor: no
- dimensions: 46 × 67 × 46 mm
- packaging: 1 pc, blister



P3306 1/4/-/36
14 56 000 060 EMN100

- source of light: 1× LED 5 mm in diameter
- light color: cool white
- power source: 230 V~/50 Hz, max. 0,3 W
- switch
- automatic on/off
- photosensor
- motion sensor: no
- dimensions: 60 × 60 × 73 mm
- packaging: 1 pc, blister



P3313 1/-/4/16
14 56 000 100 P3313

- source of light: LED
- light color: warm white
- power source: 230 V~/50 Hz
- automatic on/off
- photosensor
- motion sensor: no
- dimensions: 51 × 56 × 51 mm
- packaging: 1 pc, blister



P3314 1/-/-/20
14 56 000 110 P3314



www.emos.eu

Order Code
Item Number

Packaging
Type

- source of light: LED
- light color: warm white
- power source: 230 V~/50 Hz
- automatic on/off
- photosensor
- motion sensor: no
- dimensions: 63 × 57 × 63 mm
- packaging: 1 pc, blister



P3315 1/-/-/20
14 56 000 120 P3315

- source of light: LED
- light color: warm white
- power source: 230 V~/50 Hz
- switch
- automatic on/off
- photosensor
- motion sensor: no
- dimensions: 76 × 54 × 76 mm
- packaging: 1 pc, blister



P3316 1/-/-/15
14 56 000 130 P3316

- source of light: LED
- light color: warm white
- power source: 230 V~/50 Hz
- switch
- automatic on/off
- photosensor
- motion sensor: no
- dimensions: 87 × 63 × 87 mm
- packaging: 1 pc, blister



P3317 1/-/-/10
14 56 000 140 P3317

- source of light: LED
- light color: warm white
- power source: 230 V
- automatic on/off
- photosensor
- motion sensor
- time delay: 90 seconds +/- 3 seconds
- dimensions: 55 × 80 × 102 mm
- packaging: 1 pc, paper blister



P3318 1/-/-/12
14 56 000 150 P3318

- source of light: SMD LED
- light color: warm white
- power source: 230 V
- switch
- automatic on/off
- photosensor
- motion sensor
- time delay: 30/60/120 seconds
- dimensions: 74 × 54 × 80 mm

▪ packaging: 1 pc, paper blister



P3319 1/-/-/15
14 56 000 160 P3319



- source of light: LED
- light color: warm white
- power source: 230 V~/50 Hz
- automatic on/off
- photosensor
- motion sensor: no
- dimensions: 79 × 66 × 79 mm
- packaging: 1 pc, blister



P3320 1/-/3/18
14 56 000 170 P3320

EMOS

LED Flashlights display box

- made of aluminium or reinforced ABS plastic
- always at hand: in the pocket, tool case or the car
- batteries included
- flashlights with maximum beam distance to 150 m
- run time up to 128 hours

- source of light: COB LED
- maximal light output: 110 lm
- maximal beam distance: 15 m
- number of lighting modes: 3
- runtime: 20–40 hrs
- focus: no
- reflective head strap: no
- impact resistance
- waterproof: no

- charging: no
- power supply: 3× AAA
- battery type: LR03 (1.5 V)
- batteries included
- dimensions: 60 × 18 × 40 mm
- weight: 21 g/56 g
- packaging: 12 pcs, display box



P3538 12/-/12/60
14 41 283 110 E-HL120

- source of light: COB LED + 3× LED
- maximal light output: 200 lm
- maximal beam distance: 17 m
- number of lighting modes: 2
- runtime: 25–128 hrs
- impact resistance
- waterproof: no
- rechargeable: no
- battery: 3× AAA

- battery type: LR03 (1.5 V)
- batteries included
- features: 1× hook, 1× magnet
- dimensions: 94 × 34 × 64 mm
- weight: 105 g
- packaging: 12 pcs, display box



P3889 12/-/12/60
14 40 833 100 E-6113



- source of light: COB LED + LED
- maximal light output: 230 lm
- maximal beam distance: 80 m
- number of lighting modes: 2
- runtime: 47-72 hrs
- impact resistance
- waterproof: no
- rechargeable: no
- battery: 3× AAA

- battery type: LR03 (1.5 V)
- batteries included
- features: clip
- dimensions: 168 × 29 × 26 mm
- weight: 64 g
- packaging: 16 pcs, display box



P3897 16/-/16/64
14 40 813 130 P3897

- source of light: LED
- maximal light output: 75 lm
- maximal beam distance: 125 m
- number of lighting modes: 1
- runtime: 15 hrs
- focus
- impact resistance
- waterproof: yes (IP43)
- rechargeable: no

- battery: 3× AAA
- battery type: LR03 (1.5 V)
- batteries included
- features: hand strap
- dimensions: 120 × 35 × 35 mm
- weight: 83 g
- packaging: 12 pcs, display box



P4703 12/-/12/96
14 40 013 115 E-1512

- source of light: COB LED
- maximal light output: 100 lm
- maximal beam distance: 20 m
- number of lighting modes: 1
- runtime: 28 hrs
- impact resistance
- waterproof: yes (IP43)
- rechargeable: no
- battery: 3× AAA

- battery type: LR03 (1.5 V)
- batteries included
- features: hand strap
- dimensions: 102 × 28 × 28 mm
- packaging: 12 pcs, display box



P4705 12/-/12/96
14 40 813 160 E-2217

- source of light: 9× LED
- maximal light output: 50 lm
- maximal beam distance: 22 m
- number of lighting modes: 1
- runtime: 30 hrs
- impact resistance
- rechargeable: no
- battery: 3× AAA
- battery type: LR03 (1.5 V)

- batteries included
- dimensions: 88 × 26 × 26 mm
- weight: 71 g
- packaging: 24 pcs, display box



P3848A 24/-/24/96
14 40 093 109 LFL215-9T

- source of light: COB LED
- maximal light output: 100 lm
- maximal beam distance: 12 m
- number of lighting modes: 1
- runtime: 25 hrs
- impact resistance
- waterproof: no
- rechargeable: no
- battery: 3× AAA

- battery type: LR03 (1.5 V)
- batteries included
- features: hand strap
- dimensions: 100 × 29 × 29 mm
- weight: 34 g
- packaging: 12 pcs, display box



P4706 12/-/12/96
14 40 013 116 E2910-C



- source of light: COB LED
- maximal light output: 30 lm
- maximal beam distance: 8 m
- number of lighting modes: 4
- runtime: 3.5-60 hrs
- rechargeable: no
- battery: 2× AAA
- battery type: LR03 (1.5 V)
- batteries included

- dimensions: 63 × 25 × 35 mm
- weight: 38 g
- packaging: 12 pcs, display box



P3887 12/-/12/72
14 40 812 900 E-3205

- source of light: COB LED
- maximal light output: 350 lm
- maximal beam distance: 25 m
- number of lighting modes: 1
- runtime: 4 hrs
- impact resistance: no
- waterproof: no
- rechargeable: no
- battery: 3× AAA

- battery type: LR03 (1.5 V)
- batteries included
- features: clip, 1× magnet
- dimensions: 42 × 118 × 30 mm
- weight: 48 g
- packaging: 12 pcs, display box



P4715 12/-/12/36
14 40 113 100 P4715

- source of light: LED
- maximal light output: 10 lm
- number of lighting modes: 2
- runtime: 160 hrs
- impact resistance
- waterproof: yes (IP43)
- rechargeable: no
- battery: 2× CR2032
- battery type: CR2032 (3 V)

- batteries included
- features: arm band
- dimensions: 190 × 35 × 17 mm
- weight: 44 g
- packaging: 16 pcs, display box



P4713 16/-/16/32
14 40 812 903 P4713

- source of light: COB LED
- maximal light output: 750 lm
- maximal beam distance: 40 m
- number of lighting modes: 7
- runtime: 45 min - 2 h
- impact resistance
- waterproof: yes (IP44)
- rechargeable
- battery: Li-pol

- battery type: 500 mAh/3.7 V
- batteries included
- recharge time: 1 h
- power connector type: USB C
- features: clip, 1× magnet, rotary stand, bottle opener
- dimensions: 61 × 45 × 21 mm
- weight: 37 g
- packaging: 10 pcs, display box



P4714 10/-/10/40
14 50 000 410 P4714

LED Keychains display box

- cute LED keychains for children
- different designs and motives
- some also make a sound when lit up
- powered by 3 button batteries (included)

- source of light: LED
- maximal light output: 5 lm
- number of lighting modes: 1
- rechargeable: no
- battery: 3× 1.5 V LR54
- battery type: LR54 (1.5 V)
- batteries included
- packaging: 24 pcs, display box



P4712

24/-/24/96

14 39 013 901

E-1321; E-1322;
E-1323; E-1324

- source of light: LED
- maximal light output: 5 lm
- number of lighting modes: 1
- rechargeable: no
- battery: 3× 1.5 V LR54
- battery type: LR54 (1.5 V)
- batteries included
- packaging: 24 pcs, display box



P4711

24/-/24/96

14 39 013 900

E-1325; E-1326;
E-1327; E-1328

- source of light: 1× LED
- maximal light output: 5 lm
- number of lighting modes: 1
- impact resistance: no
- waterproof: no
- rechargeable: no
- battery: 3× LR54
- battery type: LR54 (1.5 V)
- batteries included

▪ packaging: 24 pcs, display box



P4710

24/-/24/96

14 39 011 900

E-1317; E-1318;
E-1319; E-1320

Insect killer

- electric trap for reliable protection from pesky insects
- 1 m lead-in cable

- source of light: UV-A LED tube
- number of lighting modes: 1
- battery: 220-240 V~/50 Hz
- features: hand strap
- dimensions: 136 × 240 mm
- packaging: 1 pc, box



P4104

1/-/-/6

14 48 000 040

P4104

Spare parts

- primarily as accessory to rechargeable LED torches
- socket adapters
- maintenance-free lead-acid accumulators
- switches

V94420

1/-/-/90

16 06 022 000

LG060030EP
(LGSPSA060030E)



8 595025 394460



input voltage: 230 V~, 50/60 Hz = designed for: 3810. 3 W (P2306) lamp = output voltage: 6 V= = output current: 300 mA = size of the connector: 5.5 × 2.5/9.5 mm = power supply type: cable with DC connector = dimensions: 71 × 42 × 55 mm = packaging: 1 pc, box

P2398

1/-/-/500

14 33 010 008

3810LED



8 595025 366382



packaging: 1 pc

P2399

1/-/-/500

14 33 010 009

3810



8 595025 361141



packaging: 1 pc

B9664

1/-/-/20

12 01 001 800

DHB440



8 595025 394477



for lanterns: 3810 - 3 W (P2306), 3810-10 W (P2307) = chemical constitution: Pb = voltage: 4 V = capacity: 4 Ah = dimensions: 70 × 47 × 101 mm = packaging: 1 pc

Lighting



Light sources

LED bulbs

Filament

- maximum lighting efficiency with minimum energy consumption
- acts as a perfect replacement for tungsten filament bulbs
- instantly illuminates 100% at the flick of a switch
- high luminous efficacy up to 212 lm/W
- use: modern interiors, reception areas



- replacement of incandescent bulb: 60 W
- shape: A60
- luminous flux: 806 lm
- color temperature: 2 700 K
- power: 3.8 W
- luminous efficacy: 212 lm/W
- energy efficiency class: A
- beam angle: 360°
- color rendering index (CRI): Ra >80

- voltage: 230 V~/50 Hz
- dimensions: 60 × 60 × 108 mm
- packaging: 1 pc, small box



ZF5147 1/-/10/40
15 25 283 273 EMOS

- replacement of incandescent bulb: 60 W
- shape: A60
- luminous flux: 806 lm
- color temperature: 2 700 K
- power: 3.8 W
- luminous efficacy: 212 lm/W
- energy efficiency class: A
- beam angle: 360°
- color rendering index (CRI): Ra >80

- voltage: 230 V~/50 Hz
- dimensions: 60 × 60 × 108 mm
- packaging: 3 pcs, small box



ZF5147.3 3/-/12/48
15 25 283 274 EMOS



www.emos.eu

Order Code
Item Number

Packaging
Type

- = replacement of incandescent bulb: 60 W
- = shape: A60
- = luminous flux: 806 lm
- = color temperature: 4 000 K
- = power: 3.8 W
- = luminous efficacy: 212 lm/W
- = energy efficiency class: A
- = beam angle: 360°
- = color rendering index (CRI): Ra >80

- = voltage: 230 V~/50 Hz
- = dimensions: 60 × 60 × 108 mm
- = packaging: 1 pc, small box



ZF5148
15 25 283 410

1/-/10/40
EMOS

- = replacement of incandescent bulb: 60 W
- = shape: A60
- = luminous flux: 806 lm
- = color temperature: 4 000 K
- = power: 3.8 W
- = luminous efficacy: 212 lm/W
- = energy efficiency class: A
- = beam angle: 360°
- = color rendering index (CRI): Ra >80

- = voltage: 230 V~/50 Hz
- = dimensions: 60 × 60 × 108 mm
- = packaging: 3 pcs, small box



ZF5148.3
15 25 283 411

3/-/12/48
EMOS

- = replacement of incandescent bulb: 75 W
- = shape: A60
- = luminous flux: 1 060 lm
- = color temperature: 2 700 K
- = power: 5 W
- = luminous efficacy: 212 lm/W
- = energy efficiency class: A
- = beam angle: 360°
- = color rendering index (CRI): Ra >80

- = voltage: 230 V~/50 Hz
- = dimensions: 60 × 60 × 108 mm
- = packaging: 1 pc, small box



ZF5157
15 25 283 275

1/-/10/40
EMOS

- = replacement of incandescent bulb: 75 W
- = shape: A60
- = luminous flux: 1 060 lm
- = color temperature: 2 700 K
- = power: 5 W
- = luminous efficacy: 212 lm/W
- = energy efficiency class: A
- = beam angle: 360°
- = color rendering index (CRI): Ra >80

- = voltage: 230 V~/50 Hz
- = dimensions: 60 × 60 × 108 mm
- = packaging: 3 pcs, small box



ZF5157.3
15 25 283 276

3/-/12/48
EMOS

- = replacement of incandescent bulb: 75 W
- = shape: A60
- = luminous flux: 1 060 lm
- = color temperature: 4 000 K
- = power: 5 W
- = luminous efficacy: 212 lm/W
- = energy efficiency class: A
- = beam angle: 360°
- = color rendering index (CRI): Ra >80

- = voltage: 230 V~/50 Hz
- = dimensions: 60 × 60 × 108 mm
- = packaging: 1 pc, small box



ZF5158
15 25 283 412

1/-/10/40
EMOS



www.emos.eu

Order Code
Item Number

Packaging
Type

- replacement of incandescent bulb: 75 W
- shape: A60
- luminous flux: 1 060 lm
- color temperature: 4 000 K
- power: 5 W
- luminous efficacy: 212 lm/W
- energy efficiency class: A
- beam angle: 360°
- color rendering index (CRI): Ra >80

- voltage: 230 V~/50 Hz
- dimensions: 60 × 60 × 108 mm
- packaging: 3 pcs, small box



ZF5158.3
15 25 283 413

3/-/12/48
EMOS

- replacement of incandescent bulb: 100 W
- shape: A60
- luminous flux: 1 521 lm
- color temperature: 2 700 K
- power: 7.2 W
- luminous efficacy: 211 lm/W
- energy efficiency class: A
- beam angle: 360°
- color rendering index (CRI): Ra >80

- voltage: 230 V~/50 Hz
- dimensions: 60 × 60 × 108 mm
- packaging: 1 pc, small box



ZF5167
15 25 283 279

1/-/10/20
ZF5167

- replacement of incandescent bulb: 100 W
- shape: A60
- luminous flux: 1 521 lm
- color temperature: 4 000 K
- power: 7.2 W
- luminous efficacy: 211 lm/W
- energy efficiency class: A
- beam angle: 360°
- color rendering index (CRI): Ra >80

- voltage: 230 V~/50 Hz
- dimensions: 60 × 60 × 108 mm
- packaging: 1 pc, small box



ZF5168
15 25 283 417

1/-/10/20
ZF5168

- replacement of incandescent bulb: 75 W
- dimmable
- shape: A60
- luminous flux: 1 055 lm
- color temperature: 2 700 K
- power: 7.5 W
- luminous efficacy: 141 lm/W
- energy efficiency class: D
- beam angle: 320°

- color rendering index (CRI): Ra >80
- voltage: 230 V~/50 Hz
- dimensions: 60 × 60 × 106 mm
- packaging: 1 pc, small box



ZF5154D
15 25 283 277

1/-/10/40
ZF5154D

- replacement of incandescent bulb: 75 W
- dimmable
- shape: A60
- luminous flux: 1 055 lm
- color temperature: 4 000 K
- power: 7.5 W
- luminous efficacy: 141 lm/W
- energy efficiency class: D
- beam angle: 320°

- color rendering index (CRI): Ra >80
- voltage: 230 V~/50 Hz
- dimensions: 60 × 60 × 106 mm
- packaging: 1 pc, small box



ZF5254D
15 25 283 415

1/-/10/40
ZF5254D

- replacement of incandescent bulb: 100 W
- dimmable
- shape: A60
- luminous flux: 1 521 lm
- color temperature: 2 700 K
- power: 11 W
- luminous efficacy: 138 lm/W
- energy efficiency class: D
- beam angle: 320°

- color rendering index (CRI): Ra >80
- voltage: 230 V~/50 Hz
- dimensions: 60 × 60 × 108 mm
- packaging: 1 pc, small box



ZF5164D 1/-/10/20
15 25 283 278 ZF5164D

- replacement of incandescent bulb: 100 W
- dimmable
- shape: A60
- luminous flux: 1 521 lm
- color temperature: 4 000 K
- power: 11 W
- luminous efficacy: 138 lm/W
- energy efficiency class: D
- beam angle: 320°

- color rendering index (CRI): Ra >80
- voltage: 230 V~/50 Hz
- dimensions: 60 × 60 × 108 mm
- packaging: 1 pc, small box



ZF5264D 1/-/10/20
15 25 283 416 ZF5264D

- replacement of incandescent bulb: 40 W
- shape: A60
- luminous flux: 470 lm
- color temperature: 2 700 K
- power: 3.4 W
- luminous efficacy: 138 lm/W
- energy efficiency class: D
- beam angle: 360°
- color rendering index (CRI): Ra >80

- voltage: 230 V~/50 Hz
- dimensions: 108 × 60 × 60 mm
- packaging: 1 pc, small box



ZF5D22 1/-/10/20
15 25 743 203 ZF5D22

- replacement of incandescent bulb: 40 W
- shape: A60
- luminous flux: 470 lm
- color temperature: 4 000 K
- power: 3.4 W
- luminous efficacy: 138 lm/W
- energy efficiency class: D
- beam angle: 360°
- color rendering index (CRI): Ra >80

- voltage: 230 V~/50 Hz
- dimensions: 108 × 60 × 60 mm
- packaging: 1 pc, small box



ZF5D23 1/-/10/20
15 25 733 497 ZF5D23

- replacement of incandescent bulb: 60 W
- shape: A60
- luminous flux: 806 lm
- color temperature: 2 700 K
- power: 5.9 W
- luminous efficacy: 137 lm/W
- energy efficiency class: D
- beam angle: 360°
- color rendering index (CRI): Ra >80

- voltage: 230 V~/50 Hz
- dimensions: 108 × 60 × 60 mm
- packaging: 1 pc, small box



ZF5D42 1/-/10/20
15 25 743 204 ZF5D42

- = replacement of incandescent bulb: 60 W
- = shape: A60
- = luminous flux: 806 lm
- = color temperature: 2 700 K
- = power: 5.9 W
- = luminous efficacy: 137 lm/W
- = energy efficiency class: D
- = beam angle: 360°
- = color rendering index (CRI): Ra >80

- = voltage: 230 V~/50 Hz
- = dimensions: 108 × 60 × 60 mm
- = packaging: 2 pcs, small box



ZF5D42.2 2/-/10/20
15 25 743 207 ZF5D42.2

- = replacement of incandescent bulb: 60 W
- = shape: A60
- = luminous flux: 806 lm
- = color temperature: 4 000 K
- = power: 5.9 W
- = luminous efficacy: 137 lm/W
- = energy efficiency class: D
- = beam angle: 360°
- = color rendering index (CRI): Ra >80

- = voltage: 230 V~/50 Hz
- = dimensions: 108 × 60 × 60 mm
- = packaging: 1 pc, small box



ZF5D43 1/-/10/20
15 25 733 498 ZF5D43

- = replacement of incandescent bulb: 75 W
- = shape: A60
- = luminous flux: 1 060 lm
- = color temperature: 2 700 K
- = power: 7.8 W
- = luminous efficacy: 136 lm/W
- = energy efficiency class: D
- = beam angle: 360°
- = color rendering index (CRI): Ra >80

- = voltage: 230 V~/50 Hz
- = dimensions: 108 × 60 × 60 mm
- = packaging: 1 pc, small box



ZF5D52 1/-/10/20
15 25 743 205 ZF5D52

- = replacement of incandescent bulb: 75 W
- = shape: A60
- = luminous flux: 1 060 lm
- = color temperature: 4 000 K
- = power: 7.8 W
- = luminous efficacy: 136 lm/W
- = energy efficiency class: D
- = beam angle: 360°
- = color rendering index (CRI): Ra >80

- = voltage: 230 V~/50 Hz
- = dimensions: 108 × 60 × 60 mm
- = packaging: 1 pc, small box



ZF5D53 1/-/10/20
15 25 733 499 ZF5D53

- = replacement of incandescent bulb: 100 W
- = shape: A60
- = luminous flux: 1 521 lm
- = color temperature: 2 700 K
- = power: 10.5 W
- = luminous efficacy: 145 lm/W
- = energy efficiency class: D
- = beam angle: 360°
- = color rendering index (CRI): Ra >80

- = voltage: 230 V~/50 Hz
- = dimensions: 108 × 60 × 60 mm
- = packaging: 1 pc, small box



ZF5D62 1/-/10/20
15 25 743 206 ZF5D62

- replacement of incandescent bulb: 100 W
- shape: A60
- luminous flux: 1 521 lm
- color temperature: 4 000 K
- power: 10.5 W
- luminous efficacy: 145 lm/W
- energy efficiency class: D
- beam angle: 360°
- color rendering index (CRI): Ra >80

- voltage: 230 V~/50 Hz
- dimensions: 108 × 60 × 60 mm
- packaging: 1 pc, small box



ZF5D63 1/-/10/20
15 25 743 400 ZF5D63

- replacement of incandescent bulb: 150 W
- shape: A70
- luminous flux: 2 452 lm
- color temperature: 2 700 K
- power: 18 W
- luminous efficacy: 136 lm/W
- energy efficiency class: D
- beam angle: 360°
- color rendering index (CRI): Ra >80

- voltage: 230 V~/50 Hz
- dimensions: 70 × 70 × 126 mm
- packaging: 1 pc, small box



ZF5D82 1/-/10/20
15 25 743 208 ZF5D82

- replacement of incandescent bulb: 150 W
- shape: A70
- luminous flux: 2 452 lm
- color temperature: 4 000 K
- power: 18 W
- luminous efficacy: 136 lm/W
- energy efficiency class: D
- beam angle: 360°
- color rendering index (CRI): Ra >80

- voltage: 230 V~/50 Hz
- dimensions: 70 × 70 × 126 mm
- packaging: 1 pc, small box



ZF5D83 1/-/10/20
15 25 743 401 ZF5D83

- replacement of incandescent bulb: 25 W
- shape: Mini Globe
- luminous flux: 250 lm
- color temperature: 2 700 K
- power: 1.8 W
- luminous efficacy: 139 lm/W
- energy efficiency class: D
- beam angle: 360°
- color rendering index (CRI): Ra >80

- voltage: 230 V~/50 Hz
- dimensions: 78 × 45 × 45 mm
- packaging: 1 pc, small box



ZF6D02 1/-/10/60
15 25 743 209 ZF6D02

- replacement of incandescent bulb: 25 W
- shape: Mini Globe
- luminous flux: 250 lm
- color temperature: 4 000 K
- power: 1.8 W
- luminous efficacy: 139 lm/W
- energy efficiency class: D
- beam angle: 360°
- color rendering index (CRI): Ra >80

- voltage: 230 V~/50 Hz
- dimensions: 78 × 45 × 45 mm
- packaging: 1 pc, small box



ZF6D03 1/-/10/60
15 25 743 402 ZF6D03

- replacement of incandescent bulb: 40 W
- shape: Mini Globe
- luminous flux: 470 lm
- color temperature: 2 700 K
- power: 3.4 W
- luminous efficacy: 138 lm/W
- energy efficiency class: D
- beam angle: 360°
- color rendering index (CRI): Ra >80

- voltage: 230 V~/50 Hz
- dimensions: 78 × 45 × 45 mm
- packaging: 1 pc, small box



ZF6D22 1/-/10/60
15 25 743 210 ZF6D22

- replacement of incandescent bulb: 40 W
- shape: Mini Globe
- luminous flux: 470 lm
- color temperature: 4 000 K
- power: 3.4 W
- luminous efficacy: 138 lm/W
- energy efficiency class: D
- beam angle: 360°
- color rendering index (CRI): Ra >80

- voltage: 230 V~/50 Hz
- dimensions: 78 × 45 × 45 mm
- packaging: 1 pc, small box



ZF6D23 1/-/10/60
15 25 743 403 ZF6D23

- replacement of incandescent bulb: 60 W
- shape: Mini Globe
- luminous flux: 806 lm
- color temperature: 2 700 K
- power: 5.9 W
- luminous efficacy: 137 lm/W
- energy efficiency class: D
- beam angle: 360°
- color rendering index (CRI): Ra >80

- voltage: 230 V~/50 Hz
- dimensions: 78 × 45 × 45 mm
- packaging: 1 pc, small box



ZF6D42 1/-/10/60
15 25 743 211 ZF6D42

- replacement of incandescent bulb: 60 W
- shape: Mini Globe
- luminous flux: 806 lm
- color temperature: 4 000 K
- power: 5.9 W
- luminous efficacy: 137 lm/W
- energy efficiency class: D
- beam angle: 360°
- color rendering index (CRI): Ra >80

- voltage: 230 V~/50 Hz
- dimensions: 78 × 45 × 45 mm
- packaging: 1 pc, small box



ZF6D43 1/-/10/60
15 25 743 404 ZF6D43

- replacement of incandescent bulb: 25 W
- shape: Mini Globe
- luminous flux: 250 lm
- color temperature: 2 700 K
- power: 1.8 W
- luminous efficacy: 139 lm/W
- energy efficiency class: D
- beam angle: 360°
- color rendering index (CRI): Ra >80

- voltage: 230 V~/50 Hz
- dimensions: 80 × 45 × 45 mm
- packaging: 1 pc, small box



ZF1D02 1/-/10/60
15 25 731 251 ZF1D02

- replacement of incandescent bulb: 25 W
- shape: Mini Globe
- luminous flux: 250 lm
- color temperature: 4 000 K
- power: 1.8 W
- luminous efficacy: 139 lm/W
- energy efficiency class: D
- beam angle: 360°
- color rendering index (CRI): Ra >80

- voltage: 230 V~/50 Hz
- dimensions: 80 × 45 × 45 mm
- packaging: 1 pc, small box



ZF1D03
15 25 731 448

1/-/10/60
ZF1D03

- replacement of incandescent bulb: 40 W
- shape: Mini Globe
- luminous flux: 470 lm
- color temperature: 2 700 K
- power: 3.4 W
- luminous efficacy: 138 lm/W
- energy efficiency class: D
- beam angle: 360°
- color rendering index (CRI): Ra >80

- voltage: 230 V~/50 Hz
- dimensions: 80 × 45 × 45 mm
- packaging: 1 pc, small box



ZF1D22
15 25 731 252

1/-/10/60
ZF1D22

- replacement of incandescent bulb: 40 W
- shape: Mini Globe
- luminous flux: 470 lm
- color temperature: 4 000 K
- power: 3.4 W
- luminous efficacy: 138 lm/W
- energy efficiency class: D
- beam angle: 360°
- color rendering index (CRI): Ra >80

- voltage: 230 V~/50 Hz
- dimensions: 80 × 45 × 45 mm
- packaging: 1 pc, small box



ZF1D23
15 25 731 449

1/-/10/60
ZF1D23

- replacement of incandescent bulb: 60 W
- shape: Mini Globe
- luminous flux: 806 lm
- color temperature: 2 700 K
- power: 5.9 W
- luminous efficacy: 137 lm/W
- energy efficiency class: D
- beam angle: 360°
- color rendering index (CRI): Ra >80

- voltage: 230 V~/50 Hz
- dimensions: 80 × 45 × 45 mm
- packaging: 1 pc, small box



ZF1D42
15 25 731 253

1/-/10/60
ZF1D42

- replacement of incandescent bulb: 60 W
- shape: Mini Globe
- luminous flux: 806 lm
- color temperature: 4 000 K
- power: 5.9 W
- luminous efficacy: 137 lm/W
- energy efficiency class: D
- beam angle: 360°
- color rendering index (CRI): Ra >80

- voltage: 230 V~/50 Hz
- dimensions: 80 × 45 × 45 mm
- packaging: 1 pc, small box



ZF1D43
15 25 731 450

1/-/10/60
ZF1D43

- replacement of incandescent bulb: 25 W
- shape: Candle
- luminous flux: 250 lm
- color temperature: 2 700 K
- power: 1.8 W
- luminous efficacy: 139 lm/W
- energy efficiency class: D
- beam angle: 360°
- color rendering index (CRI): Ra >80

- voltage: 230 V~/50 Hz
- dimensions: 35 × 35 × 97 mm
- packaging: 1 pc, small box



ZF3D02 1/-/10/40
15 25 731 248 ZF3D02

- replacement of incandescent bulb: 25 W
- shape: Candle
- luminous flux: 250 lm
- color temperature: 4 000 K
- power: 1.8 W
- luminous efficacy: 139 lm/W
- energy efficiency class: D
- beam angle: 360°
- color rendering index (CRI): Ra >80

- voltage: 230 V~/50 Hz
- dimensions: 35 × 35 × 97 mm
- packaging: 1 pc, small box



ZF3D03 1/-/10/40
15 25 731 445 ZF3D03

- replacement of incandescent bulb: 40 W
- shape: Candle
- luminous flux: 470 lm
- color temperature: 2 700 K
- power: 3.4 W
- luminous efficacy: 138 lm/W
- energy efficiency class: D
- beam angle: 360°
- color rendering index (CRI): Ra >80

- voltage: 230 V~/50 Hz
- dimensions: 35 × 35 × 97 mm
- packaging: 1 pc, small box



ZF3D22 1/-/10/40
15 25 731 249 ZF3D22

- replacement of incandescent bulb: 40 W
- shape: Candle
- luminous flux: 470 lm
- color temperature: 4 000 K
- power: 3.4 W
- luminous efficacy: 138 lm/W
- energy efficiency class: D
- beam angle: 360°
- color rendering index (CRI): Ra >80

- voltage: 230 V~/50 Hz
- dimensions: 35 × 35 × 97 mm
- packaging: 1 pc, small box



ZF3D23 1/-/10/40
15 25 731 446 ZF3D23

- replacement of incandescent bulb: 60 W
- shape: Candle
- luminous flux: 806 lm
- color temperature: 2 700 K
- power: 5.9 W
- luminous efficacy: 137 lm/W
- energy efficiency class: D
- beam angle: 360°
- color rendering index (CRI): Ra >80

- voltage: 230 V~/50 Hz
- dimensions: 35 × 35 × 97 mm
- packaging: 1 pc, small box



ZF3D42 1/-/10/40
15 25 731 250 ZF3D42

- replacement of incandescent bulb: 60 W
- shape: Candle
- luminous flux: 806 lm
- color temperature: 4 000 K
- power: 5.9 W
- luminous efficacy: 137 lm/W
- energy efficiency class: D
- beam angle: 360°
- color rendering index (CRI): Ra >80

- voltage: 230 V~/50 Hz
- dimensions: 35 × 35 × 97 mm
- packaging: 1 pc, small box



ZF3D43 1/-/10/40
15 25 731 447 ZF3D43

- replacement of incandescent bulb: 75 W
- shape: G95
- luminous flux: 1 055 lm
- color temperature: 2 700 K
- power: 7.8 W
- luminous efficacy: 135 lm/W
- energy efficiency class: D
- beam angle: 360°
- color rendering index (CRI): Ra >80

- voltage: 230 V~/50 Hz
- dimensions: 95 × 95 × 140 mm
- packaging: 1 pc, small box



ZF2D52 1/-/-/6
15 25 743 212 ZF2D52

- replacement of incandescent bulb: 75 W
- shape: G95
- luminous flux: 1 055 lm
- color temperature: 4 000 K
- power: 7.8 W
- luminous efficacy: 135 lm/W
- energy efficiency class: D
- beam angle: 360°
- color rendering index (CRI): Ra >80

- voltage: 230 V~/50 Hz
- dimensions: 95 × 95 × 140 mm
- packaging: 1 pc, small box



ZF2D53 1/-/-/6
15 25 743 405 ZF2D53

- replacement of incandescent bulb: 100 W
- shape: G125
- luminous flux: 1 521 lm
- color temperature: 2 700 K
- power: 11 W
- luminous efficacy: 138 lm/W
- energy efficiency class: D
- beam angle: 360°
- color rendering index (CRI): Ra >80

- voltage: 230 V~/50 Hz
- dimensions: 125 × 125 × 178 mm
- packaging: 1 pc, small box



ZF2D62 1/-/-/6
15 25 743 213 ZF2D62

- replacement of incandescent bulb: 100 W
- shape: G125
- luminous flux: 1 521 lm
- color temperature: 4 000 K
- power: 11 W
- luminous efficacy: 138 lm/W
- energy efficiency class: D
- beam angle: 360°
- color rendering index (CRI): Ra >80

- voltage: 230 V~/50 Hz
- dimensions: 125 × 125 × 178 mm
- packaging: 1 pc, small box



ZF2D63 1/-/-/6
15 25 743 406 ZF2D63



www.emos.eu

Order Code
Item Number

Packaging
Type

- replacement of incandescent bulb: 150 W
- shape: G125
- luminous flux: 2 452 lm
- color temperature: 2 700 K
- power: 18 W
- luminous efficacy: 136 lm/W
- energy efficiency class: D
- beam angle: 360°
- color rendering index (CRI): Ra >80

- voltage: 230 V~/50 Hz
- dimensions: 125 × 125 × 178 mm
- packaging: 1 pc, small box



ZF2D82 1/-/-/6
15 25 743 214 ZF2D82

- replacement of incandescent bulb: 150 W
- shape: G125
- luminous flux: 2 452 lm
- color temperature: 4 000 K
- power: 18 W
- luminous efficacy: 136 lm/W
- energy efficiency class: D
- beam angle: 360°
- color rendering index (CRI): Ra >80

- voltage: 230 V~/50 Hz
- dimensions: 125 × 125 × 178 mm
- packaging: 1 pc, small box



ZF2D83 1/-/-/6
15 25 743 407 ZF2D83

- replacement of incandescent bulb: 40 W
- shape: A60
- luminous flux: 420 lm
- color temperature: 2 200 K
- power: 4.5 W
- luminous efficacy: 93 lm/W
- energy efficiency class: F
- beam angle: 320°
- color rendering index (CRI): Ra >80

- voltage: 230 V~/50 Hz
- dimensions: 60 × 60 × 108 mm
- packaging: 1 pc, small box



Z55032 1/-/10/20
15 25 743 227 Z55032

- replacement of incandescent bulb: 20 W
- shape: Candle
- luminous flux: 225 lm
- color temperature: 2 200 K
- power: 2.5 W
- luminous efficacy: 90 lm/W
- energy efficiency class: F
- beam angle: 320°
- color rendering index (CRI): Ra >80

- voltage: 230 V~/50 Hz
- dimensions: 35 × 35 × 97 mm
- packaging: 1 pc, small box



Z53012 1/-/10/40
15 25 743 228 Z53012

- replacement of incandescent bulb: 40 W
- shape: ST64
- luminous flux: 420 lm
- color temperature: 2 200 K
- power: 4.5 W
- luminous efficacy: 93 lm/W
- energy efficiency class: F
- beam angle: 320°
- color rendering index (CRI): Ra >80

- voltage: 230 V~/50 Hz
- dimensions: 64 × 64 × 140 mm
- packaging: 1 pc, small box



Z57032 1/-/10/20
15 25 743 224 Z57032

- replacement of incandescent bulb: 40 W
- shape: G95
- luminous flux: 420 lm
- color temperature: 2 200 K
- power: 4.5 W
- luminous efficacy: 93 lm/W
- energy efficiency class: F
- beam angle: 320°
- color rendering index (CRI): Ra >80

- voltage: 230 V~/50 Hz
- dimensions: 95 × 95 × 140 mm
- packaging: 1 pc, small box



Z52032 1/-/-/6
15 25 743 226 Z52032

- replacement of incandescent bulb: 40 W
- shape: G125
- luminous flux: 420 lm
- color temperature: 2 200 K
- power: 4.5 W
- luminous efficacy: 93 lm/W
- energy efficiency class: F
- beam angle: 320°
- color rendering index (CRI): Ra >80

- voltage: 230 V~/50 Hz
- dimensions: 125 × 125 × 178 mm
- packaging: 1 pc, small box



Z58032 1/-/-/6
15 25 743 225 Z58032

Classic

- economical light source with an optimal price/quality ratio
- powerful, economical and extremely long lifetime
- 90% energy savings compared to conventional bulbs
- positive effect on human vision and health
- greater concentration of work and lower error rate
- 3 years warranty
- use: modern interiors, commercial and relaxation areas



- replacement of incandescent bulb: 40 W
- shape: A60
- luminous flux: 470 lm
- color temperature: 2 700 K
- power: 4 W
- luminous efficacy: 118 lm/W
- energy efficiency class: E
- beam angle: 180°
- color rendering index (CRI): Ra >80

- voltage: 230 V~/50 Hz
- dimensions: 60 × 60 × 107 mm
- packaging: 1 pc, small box



ZQ5E21 1/-/10/20
15 25 733 277 ZQ5E21

- replacement of incandescent bulb: 40 W
- shape: A60
- luminous flux: 470 lm
- color temperature: 4 000 K
- power: 4 W
- luminous efficacy: 118 lm/W
- energy efficiency class: E
- beam angle: 180°
- color rendering index (CRI): Ra >80

- voltage: 230 V~/50 Hz
- dimensions: 60 × 60 × 107 mm
- packaging: 1 pc, small box



ZQ5E23 1/-/10/20
15 25 733 470 ZQ5E23



www.emos.eu

Order Code
Item Number

Packaging
Type

- replacement of incandescent bulb: 50 W
- shape: A60
- luminous flux: 645 lm
- color temperature: 2 700 K
- power: 5.8 W
- luminous efficacy: 111 lm/W
- energy efficiency class: E
- beam angle: 180°
- color rendering index (CRI): Ra >80

- voltage: 230 V~/50 Hz
- dimensions: 60 × 60 × 107 mm
- packaging: 1 pc, small box



ZQ5E31 1/-/10/20
15 25 733 278 ZQ5E31

- replacement of incandescent bulb: 50 W
- shape: A60
- luminous flux: 645 lm
- color temperature: 4 000 K
- power: 5.8 W
- luminous efficacy: 111 lm/W
- energy efficiency class: E
- beam angle: 180°
- color rendering index (CRI): Ra >80

- voltage: 230 V~/50 Hz
- dimensions: 60 × 60 × 107 mm
- packaging: 1 pc, small box



ZQ5E33 1/-/10/20
15 25 733 471 ZQ5E33

- replacement of incandescent bulb: 60 W
- shape: A60
- luminous flux: 806 lm
- color temperature: 2 700 K
- power: 7 W
- luminous efficacy: 115 lm/W
- energy efficiency class: E
- beam angle: 180°
- color rendering index (CRI): Ra >80

- voltage: 230 V~/50 Hz
- dimensions: 60 × 60 × 107 mm
- packaging: 1 pc, small box



ZQ5E41 1/-/10/20
15 25 733 279 ZQ5E41

- replacement of incandescent bulb: 60 W
- shape: A60
- luminous flux: 806 lm
- color temperature: 2 700 K
- power: 7 W
- luminous efficacy: 115 lm/W
- energy efficiency class: E
- beam angle: 180°
- color rendering index (CRI): Ra >80

- voltage: 230 V~/50 Hz
- dimensions: 60 × 60 × 107 mm
- packaging: 3 pcs, small box



ZQ5E41.3 3/-/15/30
15 25 733 282 ZQ5E41.3

- replacement of incandescent bulb: 60 W
- shape: A60
- luminous flux: 806 lm
- color temperature: 4 000 K
- power: 7 W
- luminous efficacy: 115 lm/W
- energy efficiency class: E
- beam angle: 180°
- color rendering index (CRI): Ra >80

- voltage: 230 V~/50 Hz
- dimensions: 60 × 60 × 107 mm
- packaging: 1 pc, small box



ZQ5E43 1/-/10/20
15 25 733 472 ZQ5E43

- replacement of incandescent bulb: 60 W
- shape: A60
- luminous flux: 806 lm
- color temperature: 4 000 K
- power: 7 W
- luminous efficacy: 115 lm/W
- energy efficiency class: E
- beam angle: 180°
- color rendering index (CRI): Ra >80

- voltage: 230 V~/50 Hz
- dimensions: 60 × 60 × 107 mm
- packaging: 3 pcs, small box



ZQ5E43.3 3/-/15/30
15 25 733 475 ZQ5E43.3

- replacement of incandescent bulb: 60 W
- shape: A60
- luminous flux: 806 lm
- color temperature: 6 500 K
- power: 7 W
- luminous efficacy: 115 lm/W
- energy efficiency class: E
- beam angle: 180°
- color rendering index (CRI): Ra >80

- voltage: 230 V~/50 Hz
- dimensions: 60 × 60 × 107 mm
- packaging: 1 pc, small box



ZQ5E44 1/-/10/20
15 25 733 121 ZQ5E44

- replacement of incandescent bulb: 75 W
- shape: A60
- luminous flux: 1 055 lm
- color temperature: 2 700 K
- power: 9.5 W
- luminous efficacy: 111 lm/W
- energy efficiency class: E
- beam angle: 180°
- color rendering index (CRI): Ra >80

- voltage: 230 V~/50 Hz
- dimensions: 60 × 60 × 109 mm
- packaging: 1 pc, small box



ZQ5E51 1/-/10/20
15 25 733 280 ZQ5E51

- replacement of incandescent bulb: 75 W
- shape: A60
- luminous flux: 1 055 lm
- color temperature: 2 700 K
- power: 9.5 W
- luminous efficacy: 111 lm/W
- energy efficiency class: E
- beam angle: 180°
- color rendering index (CRI): Ra >80

- voltage: 230 V~/50 Hz
- dimensions: 60 × 60 × 109 mm
- packaging: 3 pcs, small box



ZQ5E51.3 3/-/15/30
15 25 733 284 ZQ5E51.3

- replacement of incandescent bulb: 75 W
- shape: A60
- luminous flux: 1 055 lm
- color temperature: 4 000 K
- power: 9.5 W
- luminous efficacy: 111 lm/W
- energy efficiency class: E
- beam angle: 180°
- color rendering index (CRI): Ra >80

- voltage: 230 V~/50 Hz
- dimensions: 60 × 60 × 109 mm
- packaging: 1 pc, small box



ZQ5E53 1/-/10/20
15 25 733 473 ZQ5E53



www.emos.eu

Order Code
Item Number

Packaging
Type

- = replacement of incandescent bulb: 75 W
- = shape: A60
- = luminous flux: 1 055 lm
- = color temperature: 4 000 K
- = power: 9.5 W
- = luminous efficacy: 111 lm/W
- = energy efficiency class: E
- = beam angle: 180°
- = color rendering index (CRI): Ra >80

- = voltage: 230 V~/50 Hz
- = dimensions: 60 × 60 × 109 mm
- = packaging: 3 pcs, small box



ZQ5E53.3 3/-/15/30
15 25 733 477 ZQ5E53.3

- = replacement of incandescent bulb: 75 W
- = shape: A60
- = luminous flux: 1 055 lm
- = color temperature: 6 500 K
- = power: 9.5 W
- = luminous efficacy: 111 lm/W
- = energy efficiency class: E
- = beam angle: 180°
- = color rendering index (CRI): Ra >80

- = voltage: 230 V~/50 Hz
- = dimensions: 60 × 60 × 109 mm
- = packaging: 1 pc, small box



ZQ5E54 1/-/10/20
15 25 733 122 ZQ5E54

- = replacement of incandescent bulb: 75 W
- = dimmable
- = shape: A60
- = luminous flux: 1 060 lm
- = color temperature: 2 700 K
- = power: 10.5 W
- = luminous efficacy: 101 lm/W
- = energy efficiency class: F
- = beam angle: 160°

- = color rendering index (CRI): Ra >80
- = voltage: 230 V~/50 Hz
- = dimensions: 120 × 60 × 60 mm
- = packaging: 1 pc, small box



ZL4206 1/-/10/40
15 25 653 206 ZL4206

- = replacement of incandescent bulb: 100 W
- = shape: A60
- = luminous flux: 1 521 lm
- = color temperature: 2 700 K
- = power: 13 W
- = luminous efficacy: 117 lm/W
- = energy efficiency class: E
- = beam angle: 180°
- = color rendering index (CRI): Ra >80

- = voltage: 230 V~/50 Hz
- = dimensions: 60 × 60 × 120 mm
- = packaging: 1 pc, small box



ZQ5E61 1/-/10/20
15 25 733 281 ZQ5E61

- = replacement of incandescent bulb: 100 W
- = shape: A60
- = luminous flux: 1 521 lm
- = color temperature: 2 700 K
- = power: 13 W
- = luminous efficacy: 117 lm/W
- = energy efficiency class: E
- = beam angle: 180°
- = color rendering index (CRI): Ra >80

- = voltage: 230 V~/50 Hz
- = dimensions: 60 × 60 × 120 mm
- = packaging: 3 pcs, small box



ZQ5E61.3 3/-/15/30
15 25 733 285 ZQ5E61.3



www.emos.eu

Order Code
Item Number

Packaging
Type

- replacement of incandescent bulb: 100 W
- shape: A60
- luminous flux: 1 521 lm
- color temperature: 4 000 K
- power: 13 W
- luminous efficacy: 117 lm/W
- energy efficiency class: E
- beam angle: 180°
- color rendering index (CRI): Ra >80

- voltage: 230 V~/50 Hz
- dimensions: 60 × 60 × 120 mm
- packaging: 1 pc, small box



ZQ5E63 1/-/10/20
15 25 733 474 ZQ5E63

- replacement of incandescent bulb: 100 W
- shape: A60
- luminous flux: 1 521 lm
- color temperature: 4 000 K
- power: 13 W
- luminous efficacy: 117 lm/W
- energy efficiency class: E
- beam angle: 180°
- color rendering index (CRI): Ra >80

- voltage: 230 V~/50 Hz
- dimensions: 60 × 60 × 120 mm
- packaging: 3 pcs, small box



ZQ5E63.3 3/-/15/30
15 25 733 478 ZQ5E63.3

- replacement of incandescent bulb: 100 W
- shape: A60
- luminous flux: 1 521 lm
- color temperature: 6 500 K
- power: 13 W
- luminous efficacy: 117 lm/W
- energy efficiency class: E
- beam angle: 180°
- color rendering index (CRI): Ra >80

- voltage: 230 V~/50 Hz
- dimensions: 60 × 60 × 120 mm
- packaging: 1 pc, small box



ZQ5E64 1/-/10/20
15 25 733 123 ZQ5E64

- replacement of incandescent bulb: 120 W
- shape: A70
- luminous flux: 1 901 lm
- color temperature: 2 700 K
- power: 16 W
- luminous efficacy: 119 lm/W
- energy efficiency class: E
- beam angle: 180°
- color rendering index (CRI): Ra >80

- voltage: 230 V~/50 Hz
- dimensions: 71 × 71 × 142 mm
- packaging: 1 pc, small box



ZQ5E71 1/-/10/20
15 25 733 286 ZQ5E71

- replacement of incandescent bulb: 120 W
- shape: A70
- luminous flux: 1 901 lm
- color temperature: 4 000 K
- power: 16 W
- luminous efficacy: 119 lm/W
- energy efficiency class: E
- beam angle: 180°
- color rendering index (CRI): Ra >80

- voltage: 230 V~/50 Hz
- dimensions: 71 × 71 × 142 mm
- packaging: 1 pc, small box



ZQ5E73 1/-/10/20
15 25 733 479 ZQ5E73

- replacement of incandescent bulb: 120 W
- shape: A70
- luminous flux: 1 901 lm
- color temperature: 6 500 K
- power: 16 W
- luminous efficacy: 119 lm/W
- energy efficiency class: E
- beam angle: 180°
- color rendering index (CRI): Ra >80

- voltage: 230 V~/50 Hz
- dimensions: 71 × 71 × 142 mm
- packaging: 1 pc, small box



ZQ5E74 1/-/10/20
15 25 733 124 ZQ5E74

- replacement of incandescent bulb: 150 W
- shape: A80
- luminous flux: 2 452 lm
- color temperature: 2 700 K
- power: 20 W
- luminous efficacy: 123 lm/W
- energy efficiency class: E
- beam angle: 180°
- color rendering index (CRI): Ra >80

- voltage: 230 V~/50 Hz
- dimensions: 80 × 80 × 156 mm
- packaging: 1 pc, small box



ZQ5E81 1/-/10/20
15 25 733 287 ZQ5E81

- replacement of incandescent bulb: 150 W
- shape: A80
- luminous flux: 2 452 lm
- color temperature: 4 000 K
- power: 20 W
- luminous efficacy: 123 lm/W
- energy efficiency class: E
- beam angle: 180°
- color rendering index (CRI): Ra >80

- voltage: 230 V~/50 Hz
- dimensions: 80 × 80 × 156 mm
- packaging: 1 pc, small box



ZQ5E83 1/-/10/20
15 25 733 480 ZQ5E83

- replacement of incandescent bulb: 150 W
- shape: A80
- luminous flux: 2 452 lm
- color temperature: 6 500 K
- power: 20 W
- luminous efficacy: 123 lm/W
- energy efficiency class: E
- beam angle: 180°
- color rendering index (CRI): Ra >80

- voltage: 230 V~/50 Hz
- dimensions: 80 × 80 × 156 mm
- packaging: 1 pc, small box



ZQ5E84 1/-/10/20
15 25 733 125 ZQ5E84

- replacement of incandescent bulb: 200 W
- shape: A95
- luminous flux: 3 452 lm
- color temperature: 2 700 K
- power: 28 W
- luminous efficacy: 123 lm/W
- energy efficiency class: E
- beam angle: 180°
- color rendering index (CRI): Ra >80

- voltage: 230 V~/50 Hz
- dimensions: 95 × 95 × 178 mm
- packaging: 1 pc, small box



ZQ5E91 1/-/3/9
15 25 743 215 ZQ5E91

- replacement of incandescent bulb: 200 W
- shape: A95
- luminous flux: 3 452 lm
- color temperature: 4 000 K
- power: 28 W
- luminous efficacy: 123 lm/W
- energy efficiency class: E
- beam angle: 180°
- color rendering index (CRI): Ra >80

- voltage: 230 V~/50 Hz
- dimensions: 95 × 95 × 178 mm
- packaging: 1 pc, small box



ZQ5E93 1/-/3/9
15 25 743 408 ZQ5E93

- replacement of incandescent bulb: 40 W
- shape: R50
- luminous flux: 470 lm
- color temperature: 2 700 K
- power: 4.2 W
- luminous efficacy: 112 lm/W
- energy efficiency class: E
- beam angle: 120°
- color rendering index (CRI): Ra >80

- voltage: 230 V~/50 Hz
- dimensions: 50 × 50 × 83 mm
- packaging: 1 pc, small box



ZQ7E21 1/-/10/30
15 25 731 243 ZQ7E21

- replacement of incandescent bulb: 40 W
- shape: R50
- luminous flux: 470 lm
- color temperature: 4 000 K
- power: 4.2 W
- luminous efficacy: 112 lm/W
- energy efficiency class: E
- beam angle: 120°
- color rendering index (CRI): Ra >80

- voltage: 230 V~/50 Hz
- dimensions: 50 × 50 × 83 mm
- packaging: 1 pc, small box



ZQ7E23 1/-/10/30
15 25 731 442 ZQ7E23

- replacement of incandescent bulb: 60 W
- shape: R63
- luminous flux: 806 lm
- color temperature: 2 700 K
- power: 7 W
- luminous efficacy: 115 lm/W
- energy efficiency class: E
- beam angle: 120°
- color rendering index (CRI): Ra >80

- voltage: 230 V~/50 Hz
- dimensions: 63 × 63 × 97 mm
- packaging: 1 pc, small box



ZQ7E41 1/-/10/20
15 25 733 294 ZQ7E41

- replacement of incandescent bulb: 60 W
- shape: R63
- luminous flux: 806 lm
- color temperature: 4 000 K
- power: 7 W
- luminous efficacy: 115 lm/W
- energy efficiency class: E
- beam angle: 120°
- color rendering index (CRI): Ra >80

- voltage: 230 V~/50 Hz
- dimensions: 63 × 63 × 97 mm
- packaging: 1 pc, small box



ZQ7E43 1/-/10/20
15 25 733 487 ZQ7E43

- replacement of incandescent bulb: 32 W
- shape: Mini Globe
- luminous flux: 350 lm
- color temperature: 2 700 K
- power: 2.5 W
- luminous efficacy: 140 lm/W
- energy efficiency class: D
- beam angle: 150°
- color rendering index (CRI): Ra >80

- voltage: 230 V~/50 Hz
- dimensions: 45 × 45 × 77 mm
- packaging: 1 pc, small box



ZQ6D11 1/-/10/40
15 25 733 272 ZQ6D11

- replacement of incandescent bulb: 32 W
- shape: Mini Globe
- luminous flux: 350 lm
- color temperature: 4 000 K
- power: 2.5 W
- luminous efficacy: 140 lm/W
- energy efficiency class: D
- beam angle: 150°
- color rendering index (CRI): Ra >80

- voltage: 230 V~/50 Hz
- dimensions: 45 × 45 × 77 mm
- packaging: 1 pc, small box



ZQ6D13 1/-/10/40
15 25 733 465 ZQ6D13

- replacement of incandescent bulb: 40 W
- shape: Mini Globe
- luminous flux: 470 lm
- color temperature: 2 700 K
- power: 4.2 W
- luminous efficacy: 112 lm/W
- energy efficiency class: E
- beam angle: 150°
- color rendering index (CRI): Ra >80

- voltage: 230 V~/50 Hz
- dimensions: 45 × 45 × 77 mm
- packaging: 1 pc, small box



ZQ6E21 1/-/10/40
15 25 733 291 ZQ6E21

- replacement of incandescent bulb: 40 W
- shape: Mini Globe
- luminous flux: 470 lm
- color temperature: 2 700 K
- power: 4.2 W
- luminous efficacy: 112 lm/W
- energy efficiency class: E
- beam angle: 150°
- color rendering index (CRI): Ra >80

- voltage: 230 V~/50 Hz
- dimensions: 45 × 45 × 77 mm
- packaging: 3 pcs, small box



ZQ6E21.3 3/-/15/60
15 25 733 292 ZQ6E21.3

- replacement of incandescent bulb: 40 W
- shape: Mini Globe
- luminous flux: 470 lm
- color temperature: 4 000 K
- power: 4.2 W
- luminous efficacy: 112 lm/W
- energy efficiency class: E
- beam angle: 150°
- color rendering index (CRI): Ra >80

- voltage: 230 V~/50 Hz
- dimensions: 45 × 45 × 77 mm
- packaging: 1 pc, small box



ZQ6E23 1/-/10/40
15 25 733 484 ZQ6E23

- replacement of incandescent bulb: 40 W
- shape: Mini Globe
- luminous flux: 470 lm
- color temperature: 4 000 K
- power: 4.2 W
- luminous efficacy: 112 lm/W
- energy efficiency class: E
- beam angle: 150°
- color rendering index (CRI): Ra >80

- voltage: 230 V~/50 Hz
- dimensions: 45 × 45 × 77 mm
- packaging: 3 pcs, small box



ZQ6E23.3 3/-/15/60
15 25 733 485 ZQ6E23.3

- replacement of incandescent bulb: 40 W
- shape: Mini Globe
- luminous flux: 470 lm
- color temperature: 6 500 K
- power: 4.2 W
- luminous efficacy: 112 lm/W
- energy efficiency class: E
- beam angle: 150°
- color rendering index (CRI): Ra >80

- voltage: 230 V~/50 Hz
- dimensions: 45 × 45 × 77 mm
- packaging: 1 pc, small box



ZQ6E24 1/-/10/40
15 25 733 126 ZQ6E24

- replacement of incandescent bulb: 60 W
- shape: Mini Globe
- luminous flux: 806 lm
- color temperature: 2 700 K
- power: 6.5 W
- luminous efficacy: 124 lm/W
- energy efficiency class: E
- beam angle: 150°
- color rendering index (CRI): Ra >80

- voltage: 230 V~/50 Hz
- dimensions: 45 × 45 × 77 mm
- packaging: 1 pc, small box



ZQ6E41 1/-/10/40
15 25 733 293 ZQ6E41

- replacement of incandescent bulb: 60 W
- shape: Mini Globe
- luminous flux: 806 lm
- color temperature: 4 000 K
- power: 6.5 W
- luminous efficacy: 124 lm/W
- energy efficiency class: E
- beam angle: 150°
- color rendering index (CRI): Ra >80

- voltage: 230 V~/50 Hz
- dimensions: 45 × 45 × 77 mm
- packaging: 1 pc, small box



ZQ6E43 1/-/10/40
15 25 733 486 ZQ6E43

- replacement of incandescent bulb: 60 W
- shape: Mini Globe
- luminous flux: 806 lm
- color temperature: 6 500 K
- power: 6.5 W
- luminous efficacy: 124 lm/W
- energy efficiency class: E
- beam angle: 150°
- color rendering index (CRI): Ra >80

- voltage: 230 V~/50 Hz
- dimensions: 45 × 45 × 77 mm
- packaging: 1 pc, small box



ZQ6E44 1/-/10/40
15 25 733 127 ZQ6E44

- replacement of incandescent bulb: 32 W
- shape: Mini Globe
- luminous flux: 350 lm
- color temperature: 2 700 K
- power: 2.5 W
- luminous efficacy: 140 lm/W
- energy efficiency class: D
- beam angle: 150°
- color rendering index (CRI): Ra >80

- voltage: 230 V~/50 Hz
- dimensions: 45 × 45 × 82 mm
- packaging: 1 pc, small box



ZQ1D11 1/-/10/40
15 25 731 230 ZQ1D11

- replacement of incandescent bulb: 32 W
- shape: Mini Globe
- luminous flux: 350 lm
- color temperature: 4 000 K
- power: 2.5 W
- luminous efficacy: 140 lm/W
- energy efficiency class: D
- beam angle: 150°
- color rendering index (CRI): Ra >80

- voltage: 230 V~/50 Hz
- dimensions: 45 × 45 × 82 mm
- packaging: 1 pc, small box



ZQ1D13 1/-/10/40
15 25 731 429 ZQ1D13

- replacement of incandescent bulb: 40 W
- shape: Mini Globe
- luminous flux: 470 lm
- color temperature: 2 700 K
- power: 4.2 W
- luminous efficacy: 112 lm/W
- energy efficiency class: E
- beam angle: 150°
- color rendering index (CRI): Ra >80

- voltage: 230 V~/50 Hz
- dimensions: 45 × 45 × 82 mm
- packaging: 1 pc, small box



ZQ1E21 1/-/10/40
15 25 731 240 ZQ1E21

- replacement of incandescent bulb: 40 W
- shape: Mini Globe
- luminous flux: 470 lm
- color temperature: 2 700 K
- power: 4.2 W
- luminous efficacy: 112 lm/W
- energy efficiency class: E
- beam angle: 150°
- color rendering index (CRI): Ra >80

- voltage: 230 V~/50 Hz
- dimensions: 45 × 45 × 82 mm
- packaging: 3 pcs, small box



ZQ1E21.3 3/-/15/60
15 25 731 241 ZQ1E21.3

- replacement of incandescent bulb: 40 W
- shape: Mini Globe
- luminous flux: 470 lm
- color temperature: 4 000 K
- power: 4.2 W
- luminous efficacy: 112 lm/W
- energy efficiency class: E
- beam angle: 150°
- color rendering index (CRI): Ra >80

- voltage: 230 V~/50 Hz
- dimensions: 45 × 45 × 82 mm
- packaging: 1 pc, small box



ZQ1E23 1/-/10/40
15 25 731 439 ZQ1E23

- replacement of incandescent bulb: 40 W
- shape: Mini Globe
- luminous flux: 470 lm
- color temperature: 4 000 K
- power: 4.2 W
- luminous efficacy: 112 lm/W
- energy efficiency class: E
- beam angle: 150°
- color rendering index (CRI): Ra >80

- voltage: 230 V~/50 Hz
- dimensions: 45 × 45 × 82 mm
- packaging: 3 pcs, small box



ZQ1E23.3 3/-/15/60
15 25 731 440 ZQ1E23.3

- replacement of incandescent bulb: 40 W
- shape: Mini Globe
- luminous flux: 470 lm
- color temperature: 6 500 K
- power: 4.2 W
- luminous efficacy: 112 lm/W
- energy efficiency class: E
- beam angle: 150°
- color rendering index (CRI): Ra >80

- voltage: 230 V~/50 Hz
- dimensions: 45 × 45 × 82 mm
- packaging: 1 pc, small box



ZQ1E24 1/-/10/40
15 25 731 112 ZQ1E24

- replacement of incandescent bulb: 60 W
- shape: Mini Globe
- luminous flux: 806 lm
- color temperature: 2 700 K
- power: 6.5 W
- luminous efficacy: 124 lm/W
- energy efficiency class: E
- beam angle: 150°
- color rendering index (CRI): Ra >80

- voltage: 230 V~/50 Hz
- dimensions: 45 × 45 × 82 mm
- packaging: 1 pc, small box



ZQ1E41 1/-/10/40
15 25 731 242 ZQ1E41

- replacement of incandescent bulb: 60 W
- shape: Mini Globe
- luminous flux: 806 lm
- color temperature: 4 000 K
- power: 6.5 W
- luminous efficacy: 124 lm/W
- energy efficiency class: E
- beam angle: 150°
- color rendering index (CRI): Ra >80

- voltage: 230 V~/50 Hz
- dimensions: 45 × 45 × 82 mm
- packaging: 1 pc, small box



ZQ1E43 1/-/10/40
15 25 731 441 ZQ1E43

- replacement of incandescent bulb: 60 W
- shape: Mini Globe
- luminous flux: 806 lm
- color temperature: 6 500 K
- power: 6.5 W
- luminous efficacy: 124 lm/W
- energy efficiency class: E
- beam angle: 150°
- color rendering index (CRI): Ra >80

- voltage: 230 V~/50 Hz
- dimensions: 45 × 45 × 82 mm
- packaging: 1 pc, small box



ZQ1E44 1/-/10/40
15 25 731 113 ZQ1E44

- replacement of incandescent bulb: 32 W
- shape: Candle
- luminous flux: 350 lm
- color temperature: 2 700 K
- power: 2.5 W
- luminous efficacy: 140 lm/W
- energy efficiency class: D
- beam angle: 240°
- color rendering index (CRI): Ra >80

- voltage: 230 V~/50 Hz
- dimensions: 35 × 35 × 105 mm
- packaging: 1 pc, small box



ZQ4D11 1/-/10/40
15 25 733 270 ZQ4D11

- replacement of incandescent bulb: 32 W
- shape: Candle
- luminous flux: 350 lm
- color temperature: 4 000 K
- power: 2.5 W
- luminous efficacy: 140 lm/W
- energy efficiency class: D
- beam angle: 240°
- color rendering index (CRI): Ra >80

- voltage: 230 V~/50 Hz
- dimensions: 35 × 35 × 105 mm
- packaging: 1 pc, small box



ZQ4D13 1/-/10/40
15 25 733 463 ZQ4D13

- replacement of incandescent bulb: 40 W
- shape: Candle
- luminous flux: 470 lm
- color temperature: 2 700 K
- power: 4.2 W
- luminous efficacy: 112 lm/W
- energy efficiency class: E
- beam angle: 240°
- color rendering index (CRI): Ra >80

- voltage: 230 V~/50 Hz
- dimensions: 35 × 35 × 105 mm
- packaging: 1 pc, small box



ZQ4E21 1/-/10/40
15 25 733 289 ZQ4E21

- replacement of incandescent bulb: 40 W
- shape: Candle
- luminous flux: 470 lm
- color temperature: 4 000 K
- power: 4.2 W
- luminous efficacy: 112 lm/W
- energy efficiency class: E
- beam angle: 240°
- color rendering index (CRI): Ra >80

- voltage: 230 V~/50 Hz
- dimensions: 35 × 35 × 105 mm
- packaging: 1 pc, small box



ZQ4E23 1/-/10/40
15 25 733 482 ZQ4E23

- replacement of incandescent bulb: 32 W
- shape: Candle
- luminous flux: 350 lm
- color temperature: 2 700 K
- power: 2.5 W
- luminous efficacy: 140 lm/W
- energy efficiency class: D
- beam angle: 240°
- color rendering index (CRI): Ra >80

- voltage: 230 V~/50 Hz
- dimensions: 35 × 35 × 103 mm
- packaging: 1 pc, small box



ZQ3D11 1/-/10/40
15 25 731 226 ZQ3D11

- replacement of incandescent bulb: 32 W
- shape: Candle
- luminous flux: 350 lm
- color temperature: 4 000 K
- power: 2.5 W
- luminous efficacy: 140 lm/W
- energy efficiency class: D
- beam angle: 240°
- color rendering index (CRI): Ra >80

- voltage: 230 V~/50 Hz
- dimensions: 35 × 35 × 103 mm
- packaging: 1 pc, small box



ZQ3D13 1/-/10/40
15 25 731 425 ZQ3D13

- replacement of incandescent bulb: 40 W
- shape: Candle
- luminous flux: 470 lm
- color temperature: 2 700 K
- power: 4.2 W
- luminous efficacy: 112 lm/W
- energy efficiency class: E
- beam angle: 240°
- color rendering index (CRI): Ra >80

- voltage: 230 V~/50 Hz
- dimensions: 35 × 35 × 103 mm
- packaging: 1 pc, small box



ZQ3E21 1/-/10/40
15 25 731 236 ZQ3E21

- replacement of incandescent bulb: 40 W
- shape: Candle
- luminous flux: 470 lm
- color temperature: 2 700 K
- power: 4.2 W
- luminous efficacy: 112 lm/W
- energy efficiency class: E
- beam angle: 240°
- color rendering index (CRI): Ra >80

- voltage: 230 V~/50 Hz
- dimensions: 35 × 35 × 103 mm
- packaging: 3 pcs, small box



ZQ3E21.3 3/-/15/90
15 25 731 237 ZQ3E21.3

- replacement of incandescent bulb: 40 W
- shape: Candle
- luminous flux: 470 lm
- color temperature: 4 000 K
- power: 4.2 W
- luminous efficacy: 112 lm/W
- energy efficiency class: E
- beam angle: 240°
- color rendering index (CRI): Ra >80

- voltage: 230 V~/50 Hz
- dimensions: 35 × 35 × 103 mm
- packaging: 1 pc, small box



ZQ3E23 1/-/10/40
15 25 731 435 ZQ3E23

- replacement of incandescent bulb: 40 W
- shape: Candle
- luminous flux: 470 lm
- color temperature: 4 000 K
- power: 4.2 W
- luminous efficacy: 112 lm/W
- energy efficiency class: E
- beam angle: 240°
- color rendering index (CRI): Ra >80

- voltage: 230 V~/50 Hz
- dimensions: 35 × 35 × 103 mm
- packaging: 3 pcs, small box



ZQ3E23.3 3/-/15/90
15 25 731 436 ZQ3E23.3

- replacement of incandescent bulb: 40 W
- shape: Candle
- luminous flux: 470 lm
- color temperature: 6 500 K
- power: 4.2 W
- luminous efficacy: 112 lm/W
- energy efficiency class: E
- beam angle: 240°
- color rendering index (CRI): Ra >80

- voltage: 230 V~/50 Hz
- dimensions: 35 × 35 × 103 mm
- packaging: 1 pc, small box



QZ3E24 1/-/10/40
15 25 731 110 QZ3E24

- replacement of incandescent bulb: 60 W
- shape: Candle
- luminous flux: 806 lm
- color temperature: 2 700 K
- power: 6.5 W
- luminous efficacy: 124 lm/W
- energy efficiency class: E
- beam angle: 240°
- color rendering index (CRI): Ra >80

- voltage: 230 V~/50 Hz
- dimensions: 35 × 35 × 103 mm
- packaging: 1 pc, small box



QZ3E41 1/-/10/40
15 25 731 238 QZ3E41

- replacement of incandescent bulb: 60 W
- shape: Candle
- luminous flux: 806 lm
- color temperature: 4 000 K
- power: 6.5 W
- luminous efficacy: 124 lm/W
- energy efficiency class: E
- beam angle: 240°
- color rendering index (CRI): Ra >80

- voltage: 230 V~/50 Hz
- dimensions: 35 × 35 × 103 mm
- packaging: 1 pc, small box



QZ3E43 1/-/10/40
15 25 731 437 QZ3E43

- replacement of incandescent bulb: 60 W
- shape: Candle
- luminous flux: 806 lm
- color temperature: 6 500 K
- power: 6.5 W
- luminous efficacy: 124 lm/W
- energy efficiency class: E
- beam angle: 240°
- color rendering index (CRI): Ra >80

- voltage: 230 V~/50 Hz
- dimensions: 35 × 35 × 103 mm
- packaging: 1 pc, small box



QZ3E44 1/-/10/40
15 25 731 111 QZ3E44

- replacement of incandescent bulb: 32 W
- shape: MR16
- luminous flux: 345 lm
- color temperature: 3 000 K
- power: 3 W
- luminous efficacy: 115 lm/W
- energy efficiency class: E
- beam angle: 100°
- color rendering index (CRI): Ra >80

- voltage: 230 V~/50 Hz
- dimensions: 50 × 50 × 58 mm
- packaging: 1 pc, small box



QZ8E12 1/-/10/60
15 25 730 229 QZ8E12

- replacement of incandescent bulb: 32 W
- shape: MR16
- luminous flux: 345 lm
- color temperature: 3 000 K
- power: 3 W
- luminous efficacy: 115 lm/W
- energy efficiency class: E
- beam angle: 100°
- color rendering index (CRI): Ra >80

- voltage: 230 V~/50 Hz
- dimensions: 50 × 50 × 55 mm
- packaging: 1 pc, small box



ZQ8E17 1/-/10/60
15 25 730 232 ZQ8E17

- replacement of incandescent bulb: 32 W
- shape: MR16
- luminous flux: 345 lm
- color temperature: 3 000 K
- power: 3 W
- luminous efficacy: 115 lm/W
- energy efficiency class: E
- beam angle: 100°
- color rendering index (CRI): Ra >80

- voltage: 230 V~/50 Hz
- dimensions: 50 × 50 × 58 mm
- packaging: 3 pcs, small box



ZQ8E12.3 3/-/15/60
15 25 730 233 ZQ8E12.3

- replacement of incandescent bulb: 40 W
- shape: MR16
- luminous flux: 535 lm
- color temperature: 4 000 K
- power: 3 W
- luminous efficacy: 210 lm/W
- energy efficiency class: A
- beam angle: 100°
- color rendering index (CRI): Ra >80

- voltage: 230 V~/50 Hz
- dimensions: 50 × 50 × 55 mm
- packaging: 1 pc, small box



ZQ8338 1/-/10/60
15 25 730 423 ZQ8338

- replacement of incandescent bulb: 32 W
- shape: MR16
- luminous flux: 345 lm
- color temperature: 4 000 K
- power: 3 W
- luminous efficacy: 115 lm/W
- energy efficiency class: E
- beam angle: 100°
- color rendering index (CRI): Ra >80

- voltage: 230 V~/50 Hz
- dimensions: 50 × 50 × 58 mm
- packaging: 1 pc, small box



ZQ8E13 1/-/10/60
15 25 730 424 ZQ8E13

- replacement of incandescent bulb: 32 W
- shape: MR16
- luminous flux: 345 lm
- color temperature: 4 000 K
- power: 3 W
- luminous efficacy: 115 lm/W
- energy efficiency class: E
- beam angle: 100°
- color rendering index (CRI): Ra >80

- voltage: 230 V~/50 Hz
- dimensions: 50 × 50 × 55 mm
- packaging: 1 pc, small box



ZQ8E18 1/-/10/60
15 25 730 427 ZQ8E18

- replacement of incandescent bulb: 32 W
- shape: MR16
- luminous flux: 345 lm
- color temperature: 6 500 K
- power: 3 W
- luminous efficacy: 115 lm/W
- energy efficiency class: E
- beam angle: 100°
- color rendering index (CRI): Ra >80

- voltage: 230 V~/50 Hz
- dimensions: 50 × 50 × 58 mm
- packaging: 1 pc, small box



ZQ8E14 1/-/10/60
15 25 730 114 ZQ8E14

- replacement of incandescent bulb: 32 W
- shape: MR16
- luminous flux: 345 lm
- color temperature: 6 500 K
- power: 3 W
- luminous efficacy: 115 lm/W
- energy efficiency class: E
- beam angle: 100°
- color rendering index (CRI): Ra >80

- voltage: 230 V~/50 Hz
- dimensions: 50 × 50 × 55 mm
- packaging: 1 pc, small box



ZQ8E19 1/-/10/60
15 25 730 116 ZQ8E19

- replacement of incandescent bulb: 39 W
- shape: MR16
- luminous flux: 450 lm
- color temperature: 3 000 K
- power: 4 W
- luminous efficacy: 113 lm/W
- energy efficiency class: E
- beam angle: 100°
- color rendering index (CRI): Ra >80

- voltage: 230 V~/50 Hz
- dimensions: 50 × 50 × 58 mm
- packaging: 1 pc, small box



ZQ8E22 1/-/10/60
15 25 730 230 ZQ8E22

- replacement of incandescent bulb: 39 W
- shape: MR16
- luminous flux: 450 lm
- color temperature: 4 000 K
- power: 4 W
- luminous efficacy: 113 lm/W
- energy efficiency class: E
- beam angle: 100°
- color rendering index (CRI): Ra >80

- voltage: 230 V~/50 Hz
- dimensions: 50 × 50 × 58 mm
- packaging: 1 pc, small box



ZQ8E23 1/-/10/60
15 25 730 425 ZQ8E23

- replacement of incandescent bulb: 75 W
- shape: MR16
- luminous flux: 565 lm
- color temperature: 4 000 K
- power: 5.8 W
- luminous efficacy: 115 lm/W
- energy efficiency class: E
- beam angle: 36°
- color rendering index (CRI): Ra >80

- voltage: 230 V~/50 Hz
- dimensions: 50 × 50 × 56 mm
- packaging: 1 pc, small box



ZQ8E33N 1/-/10/60
15 25 730 428 ZQ8E33N

- replacement of incandescent bulb: 60 W
- dimmable
- shape: MR16
- luminous flux: 800 lm
- color temperature: 3 000 K
- power: 7 W
- luminous efficacy: 114 lm/W
- energy efficiency class: E
- beam angle: 100°

- color rendering index (CRI): Ra >80
- voltage: 230 V~/50 Hz
- dimensions: 50 × 50 × 58 mm
- packaging: 1 pc, small box



ZQ8155S 1/-/10/60
15 25 730 220 ZQ8155S

- replacement of incandescent bulb: 60 W
- dimmable
- shape: MR16
- luminous flux: 800 lm
- color temperature: 3 000 K
- power: 7 W
- luminous efficacy: 114 lm/W
- energy efficiency class: E
- beam angle: 100°

- color rendering index (CRI): Ra >80
- voltage: 230 V~/50 Hz
- dimensions: 50 × 50 × 58 mm
- packaging: 1 pc, small box



ZQ8155D 1/-/10/60
15 25 730 221 ZQ8155D

- replacement of incandescent bulb: 60 W
- shape: MR16
- luminous flux: 806 lm
- color temperature: 3 000 K
- power: 7 W
- luminous efficacy: 115 lm/W
- energy efficiency class: E
- beam angle: 100°
- color rendering index (CRI): Ra >80

- voltage: 230 V~/50 Hz
- dimensions: 50 × 50 × 58 mm
- packaging: 1 pc, small box



ZQ8E42 1/-/10/60
15 25 730 225 ZQ8E42

- replacement of incandescent bulb: 60 W
- shape: MR16
- luminous flux: 806 lm
- color temperature: 3 000 K
- power: 7 W
- luminous efficacy: 115 lm/W
- energy efficiency class: E
- beam angle: 100°
- color rendering index (CRI): Ra >80

- voltage: 230 V~/50 Hz
- dimensions: 50 × 50 × 58 mm
- packaging: 3 pcs, small box



ZQ8E42.3 3/-/15/60
15 25 730 228 ZQ8E42.3

- replacement of incandescent bulb: 60 W
- dimmable
- shape: MR16
- luminous flux: 800 lm
- color temperature: 4 000 K
- power: 7 W
- luminous efficacy: 114 lm/W
- energy efficiency class: E
- beam angle: 100°

- color rendering index (CRI): Ra >80
- voltage: 230 V~/50 Hz
- dimensions: 50 × 50 × 58 mm
- packaging: 1 pc, small box



ZQ8255S 1/-/10/60
15 25 730 415 ZQ8255S

- replacement of incandescent bulb: 60 W
- dimmable
- shape: MR16
- luminous flux: 800 lm
- color temperature: 4 000 K
- power: 7 W
- luminous efficacy: 114 lm/W
- energy efficiency class: E
- beam angle: 100°

- color rendering index (CRI): Ra >80
- voltage: 230 V~/50 Hz
- dimensions: 50 × 50 × 58 mm
- packaging: 1 pc, small box



ZQ8255D 1/-/10/60
15 25 730 416 ZQ8255D

- replacement of incandescent bulb: 60 W
- shape: MR16
- luminous flux: 806 lm
- color temperature: 4 000 K
- power: 7 W
- luminous efficacy: 115 lm/W
- energy efficiency class: E
- beam angle: 100°
- color rendering index (CRI): Ra >80

- voltage: 230 V~/50 Hz
- dimensions: 50 × 50 × 58 mm
- packaging: 1 pc, small box



ZQ8E43 1/-/10/60
15 25 730 419 ZQ8E43

- replacement of incandescent bulb: 60 W
- shape: MR16
- luminous flux: 806 lm
- color temperature: 4 000 K
- power: 7 W
- luminous efficacy: 115 lm/W
- energy efficiency class: E
- beam angle: 100°
- color rendering index (CRI): Ra >80

- voltage: 230 V~/50 Hz
- dimensions: 50 × 50 × 58 mm
- packaging: 3 pcs, small box



ZQ8E43.3 3/-/15/60
15 25 730 422 ZQ8E43.3

- replacement of incandescent bulb: 60 W
- shape: MR16
- luminous flux: 806 lm
- color temperature: 6 500 K
- power: 7 W
- luminous efficacy: 115 lm/W
- energy efficiency class: E
- beam angle: 100°
- color rendering index (CRI): Ra >80

- voltage: 230 V~/50 Hz
- dimensions: 50 × 50 × 58 mm
- packaging: 1 pc, small box



ZQ8E44 1/-/10/60
15 25 730 112 ZQ8E44

- replacement of incandescent bulb: 40 W
- dimmable
- shape: JC
- luminous flux: 470 lm
- color temperature: 3 000 K
- power: 4.2 W
- luminous efficacy: 112 lm/W
- energy efficiency class: E
- beam angle: 300°

- color rendering index (CRI): Ra >80
- voltage: 230 V~/50 Hz
- dimensions: 18 × 18 × 60 mm
- packaging: 1 pc, small box



ZQ9125D 1/-/10/60
15 25 736 211 ZQ9125D



- replacement of incandescent bulb: 40 W
- dimmable
- shape: JC
- luminous flux: 470 lm
- color temperature: 4 000 K
- power: 4.2 W
- luminous efficacy: 112 lm/W
- energy efficiency class: E
- beam angle: 300°
- color rendering index (CRI): Ra >80
- voltage: 230 V~/50 Hz
- dimensions: 18 × 18 × 60 mm
- packaging: 1 pc., small box



ZQ9225D 1/-/10/60
15 25 736 411 ZQ9225D

Basic

- most popular bulb types, found in most households
- economical replacement for obsolete tungsten filament bulbs
- low price and power consumption yet high efficiency
- lights up to 100 % immediately after pressing the switch



- replacement of incandescent bulb: 60 W
- shape: A60
- luminous flux: 806 lm
- color temperature: 3 000 K
- power: 9.4 W
- luminous efficacy: 86 lm/W
- energy efficiency class: F
- beam angle: 200°
- color rendering index (CRI): Ra >80
- voltage: 230 V~/50 Hz
- dimensions: 60 × 60 × 110 (max.) mm
- packaging: 1 pc., small box



ZL5F42 1/-/10/30
15 25 733 296 ZL5F42

- replacement of incandescent bulb: 60 W
- shape: A60
- luminous flux: 806 lm
- color temperature: 3 000 K
- power: 9.4 W
- luminous efficacy: 86 lm/W
- energy efficiency class: F
- beam angle: 200°
- color rendering index (CRI): Ra >80
- voltage: 230 V~/50 Hz
- dimensions: 60 × 60 × 110 (max.) mm
- packaging: 3 pcs., small box



ZL5F42.3 3/-/15/45
15 25 733 299 ZL5F42.3

- replacement of incandescent bulb: 60 W
- shape: A60
- luminous flux: 806 lm
- color temperature: 3 000 K
- power: 9.4 W
- luminous efficacy: 86 lm/W
- energy efficiency class: F
- beam angle: 200°
- color rendering index (CRI): Ra >80
- voltage: 230 V~/50 Hz
- dimensions: 60 × 60 × 110 (max.) mm
- packaging: 6 pcs., small box



ZL5F42.6 6/-/1/48
15 25 743 200 ZL5F42.6

- replacement of incandescent bulb: 60 W
- shape: A60
- luminous flux: 806 lm
- color temperature: 4 000 K
- power: 9.4 W
- luminous efficacy: 86 lm/W
- energy efficiency class: F
- beam angle: 200°
- color rendering index (CRI): Ra >80

- voltage: 230 V~/50 Hz
- dimensions: 60 × 60 × 110 (max.) mm
- packaging: 1 pc, small box



ZL5F43 1/-/10/30
15 25 733 492 ZL5F43

- replacement of incandescent bulb: 60 W
- shape: A60
- luminous flux: 806 lm
- color temperature: 4 000 K
- power: 9.4 W
- luminous efficacy: 86 lm/W
- energy efficiency class: F
- beam angle: 200°
- color rendering index (CRI): Ra >80

- voltage: 230 V~/50 Hz
- dimensions: 60 × 60 × 110 (max.) mm
- packaging: 3 pcs, small box



ZL5F43.3 3/-/15/45
15 25 733 495 ZL5F43.3

- replacement of incandescent bulb: 60 W
- shape: A60
- luminous flux: 806 lm
- color temperature: 4 000 K
- power: 9.4 W
- luminous efficacy: 86 lm/W
- energy efficiency class: F
- beam angle: 200°
- color rendering index (CRI): Ra >80

- voltage: 230 V~/50 Hz
- dimensions: 60 × 60 × 110 (max.) mm
- packaging: 6 pcs, small box



ZL5F43.6 6/-/-/48
15 25 733 496 ZL5F43.6

- replacement of incandescent bulb: 75 W
- shape: A60
- luminous flux: 1 055 lm
- color temperature: 3 000 K
- power: 12.4 W
- luminous efficacy: 85 lm/W
- energy efficiency class: F
- beam angle: 200°
- color rendering index (CRI): Ra >80

- voltage: 230 V~/50 Hz
- dimensions: 60 × 60 × 110 (max.) mm
- packaging: 1 pc, small box



ZL5F52 1/-/10/30
15 25 743 229 ZL5F52

- replacement of incandescent bulb: 75 W
- shape: A60
- luminous flux: 1 055 lm
- color temperature: 4 000 K
- power: 12.4 W
- luminous efficacy: 85 lm/W
- energy efficiency class: F
- beam angle: 200°
- color rendering index (CRI): Ra >80

- voltage: 230 V~/50 Hz
- dimensions: 60 × 60 × 110 (max.) mm
- packaging: 1 pc, small box



ZL5F53 1/-/10/30
15 25 743 411 ZL5F53

- replacement of incandescent bulb: 100 W
- shape: A60
- luminous flux: 1 521 lm
- color temperature: 3 000 K
- power: 17.8 W
- luminous efficacy: 85 lm/W
- energy efficiency class: F
- beam angle: 200°
- color rendering index (CRI): Ra >80

- voltage: 230 V~/50 Hz
- dimensions: 60 × 60 × 125 (max.) mm
- packaging: 1 pc, small box



ZL5F62
15 25 743 230

1/-/10/30
ZL5F62

- replacement of incandescent bulb: 100 W
- shape: A60
- luminous flux: 1 521 lm
- color temperature: 4 000 K
- power: 17.8 W
- luminous efficacy: 85 lm/W
- energy efficiency class: F
- beam angle: 200°
- color rendering index (CRI): Ra >80

- voltage: 230 V~/50 Hz
- dimensions: 60 × 60 × 125 (max.) mm
- packaging: 1 pc, small box



ZL5F63
15 25 743 412

1/-/10/30
ZL5F63

- replacement of incandescent bulb: 40 W
- shape: Mini Globe
- luminous flux: 470 lm
- color temperature: 3 000 K
- power: 5.5 W
- luminous efficacy: 85 lm/W
- energy efficiency class: F
- beam angle: 180°
- color rendering index (CRI): Ra >80

- voltage: 230 V~/50 Hz
- dimensions: 45 × 45 × 82 (max.) mm
- packaging: 1 pc, small box



ZL6F22
15 25 743 202

1/-/10/60
ZL6F22

- replacement of incandescent bulb: 40 W
- shape: Mini Globe
- luminous flux: 470 lm
- color temperature: 3 000 K
- power: 5.5 W
- luminous efficacy: 85 lm/W
- energy efficiency class: F
- beam angle: 180°
- color rendering index (CRI): Ra >80

- voltage: 230 V~/50 Hz
- dimensions: 45 × 45 × 82 (max.) mm
- packaging: 1 pc, small box



ZL1F22
15 25 731 246

1/-/10/60
ZL1F22

- replacement of incandescent bulb: 60 W
- shape: Mini Globe
- luminous flux: 806 lm
- color temperature: 3 000 K
- power: 9.4 W
- luminous efficacy: 86 lm/W
- energy efficiency class: F
- beam angle: 180°
- color rendering index (CRI): Ra >80

- voltage: 230 V~/50 Hz
- dimensions: 45 × 45 × 82 (max.) mm
- packaging: 1 pc, small box



ZL1F42
15 25 731 247

1/-/10/60
ZL1F42



www.emos.eu

Order Code
Item Number

Packaging
Type

- replacement of incandescent bulb: 60 W
- shape: Mini Globe
- luminous flux: 806 lm
- color temperature: 4 000 K
- power: 9.4 W
- luminous efficacy: 86 lm/W
- energy efficiency class: F
- beam angle: 180°
- color rendering index (CRI): Ra >80

- voltage: 230 V~/50 Hz
- dimensions: 45 × 45 × 82 (max.) mm
- packaging: 1 pc, small box



ZL1F43
15 25 731 444

1/-/10/60
ZL1F43

- replacement of incandescent bulb: 40 W
- shape: Candle
- luminous flux: 470 lm
- color temperature: 3 000 K
- power: 5.5 W
- luminous efficacy: 85 lm/W
- energy efficiency class: F
- beam angle: 180°
- color rendering index (CRI): Ra >80

- voltage: 230 V~/50 Hz
- dimensions: 35 × 35 × 105 (max.) mm
- packaging: 1 pc, small box



ZL4F22
15 25 743 201

1/-/10/60
ZL4F22

- replacement of incandescent bulb: 40 W
- shape: Candle
- luminous flux: 470 lm
- color temperature: 3 000 K
- power: 5.5 W
- luminous efficacy: 85 lm/W
- energy efficiency class: F
- beam angle: 180°
- color rendering index (CRI): Ra >80

- voltage: 230 V~/50 Hz
- dimensions: 35 × 35 × 105 (max.) mm
- packaging: 1 pc, small box



ZL3F22
15 25 731 244

1/-/10/60
ZL3F22

- replacement of incandescent bulb: 60 W
- shape: Candle
- luminous flux: 806 lm
- color temperature: 3 000 K
- power: 9.4 W
- luminous efficacy: 86 lm/W
- energy efficiency class: F
- beam angle: 180°
- color rendering index (CRI): Ra >80

- voltage: 230 V~/50 Hz
- dimensions: 35 × 35 × 110 (max.) mm
- packaging: 1 pc, small box



ZL3F42
15 25 731 245

1/-/10/60
ZL3F42

- replacement of incandescent bulb: 60 W
- shape: Candle
- luminous flux: 806 lm
- color temperature: 4 000 K
- power: 9.4 W
- luminous efficacy: 86 lm/W
- energy efficiency class: F
- beam angle: 180°
- color rendering index (CRI): Ra >80

- voltage: 230 V~/50 Hz
- dimensions: 35 × 35 × 110 (max.) mm
- packaging: 1 pc, small box



ZL3F43
15 25 731 443

1/-/10/60
ZL3F43

- replacement of incandescent bulb: 25 W
- shape: MR16
- luminous flux: 250 lm
- color temperature: 3 000 K
- power: 2.9 W
- luminous efficacy: 86 lm/W
- energy efficiency class: F
- beam angle: 110°
- color rendering index (CRI): Ra >80

- voltage: 230 V~/50 Hz
- dimensions: 50 × 50 × 58 (max.) mm
- packaging: 1 pc, small box



ZL8F02 1/-/10/90
15 25 730 234 ZL8F02

- replacement of incandescent bulb: 25 W
- shape: MR16
- luminous flux: 250 lm
- color temperature: 4 000 K
- power: 2.9 W
- luminous efficacy: 86 lm/W
- energy efficiency class: F
- beam angle: 110°
- color rendering index (CRI): Ra >80

- voltage: 230 V~/50 Hz
- dimensions: 50 × 50 × 58 (max.) mm
- packaging: 1 pc, small box



ZL8F03 1/-/10/90
15 25 730 429 ZL8F03

- replacement of incandescent bulb: 40 W
- shape: MR16
- luminous flux: 450 lm
- color temperature: 3 000 K
- power: 5.2 W
- luminous efficacy: 87 lm/W
- energy efficiency class: F
- beam angle: 110°
- color rendering index (CRI): Ra >80

- voltage: 230 V~/50 Hz
- dimensions: 50 × 50 × 58 (max.) mm
- packaging: 1 pc, small box



ZL8F22 1/-/10/90
15 25 730 235 ZL8F22

- replacement of incandescent bulb: 40 W
- shape: MR16
- luminous flux: 450 lm
- color temperature: 4 000 K
- power: 5.2 W
- luminous efficacy: 87 lm/W
- energy efficiency class: F
- beam angle: 110°
- color rendering index (CRI): Ra >80

- voltage: 230 V~/50 Hz
- dimensions: 50 × 50 × 58 (max.) mm
- packaging: 1 pc, small box



ZL8F23 1/-/10/90
15 25 730 430 ZL8F23

GoSmart Bulbs



- Remote light on/off
- Brightness, light colour and chromaticity temperature control
- Energy saving with automatic switch-off and dimming options
- Set unique lighting scenes for different activities
- Easy to install and create automations
- Connection to the home network via WIFI protocol
- Compatibility with EMOS GoSmart products and TUYA devices
- Voice control with Google Assistant and Amazon Alexa

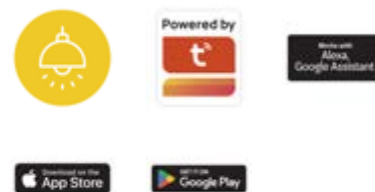

- replacement of incandescent bulb: 60 W
- dimmable
- shape: A60
- luminous flux: 806 lm
- color temperature: 2 700–6 500 K
- power: 9 W
- luminous efficacy: 90 lm/W
- energy efficiency class: F
- beam angle: 200°
- color rendering index (CRI): Ra >80
- voltage: 230 V~/50 Hz
- dimensions: 60 × 60 × 120 mm
- packaging: 1 pc, small box
- supported OS: Android, iOS
- compatibility: EMOS GoSmart, TUYA, LIDL, Smartlife
- protocol: Wi-Fi
- control by voice assistants
- notifications to the mobile app



ZQW514R 1/-/10/40
15 20 503 500 ZQW514R



- replacement of incandescent bulb: 75 W
- dimmable
- shape: A60
- luminous flux: 1 050 lm
- color temperature: 2 700–6 500 K
- power: 11 W
- luminous efficacy: 95 lm/W
- energy efficiency class: F
- beam angle: 200°
- color rendering index (CRI): Ra >80
- voltage: 230 V~/50 Hz
- dimensions: 60 × 60 × 125 mm
- packaging: 1 pc, small box
- supported OS: Android, iOS
- compatibility: EMOS GoSmart, TUYA, LIDL, Smartlife
- protocol: Wi-Fi
- control by voice assistants
- notifications to the mobile app

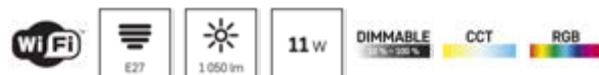

ZQW515R 1/-/10/40
15 20 503 501 ZQW515R



- replacement of incandescent bulb: 94 W
- dimmable
- shape: A65
- luminous flux: 1 400 lm
- color temperature: 2 700–6 500 K
- power: 14 W
- luminous efficacy: 100 lm/W
- energy efficiency class: F
- beam angle: 200°
- color rendering index (CRI): Ra >80
- voltage: 230 V~/50 Hz
- dimensions: 65 × 65 × 134 mm
- packaging: 1 pc, small box
- supported OS: Android, iOS
- compatibility: EMOS GoSmart, TUYA, LIDL, Smartlife
- protocol: Wi-Fi
- control by voice assistants
- notifications to the mobile app



ZQW516R 1/-/4/24
15 20 503 502 ZQW516R



- replacement of incandescent bulb: 40 W
- dimmable
- shape: Candle
- luminous flux: 470 lm
- color temperature: 2 700–6 500 K
- power: 4.8 W
- luminous efficacy: 98 lm/W
- energy efficiency class: F
- beam angle: 180°
- color rendering index (CRI): Ra >80
- voltage: 230 V~/50 Hz
- dimensions: 37 × 37 × 110 mm
- packaging: 1 pc, small box
- supported OS: Android, iOS
- compatibility: EMOS GoSmart, TUYA, LIDL, Smartlife
- protocol: Wi-Fi
- control by voice assistants
- notifications to the mobile app



ZQW322R 1/-/10/60
15 25 501 500 ZQW322R



- replacement of incandescent bulb: 35 W
- dimmable
- shape: MR16
- luminous flux: 400 lm
- color temperature: 2 700–6 500 K
- power: 4.8 W
- luminous efficacy: 83 lm/W
- energy efficiency class: G
- beam angle: 120°

- color rendering index (CRI): Ra >80
- voltage: 230 V~/50 Hz
- dimensions: 50 × 50 × 56.5 mm
- packaging: 1 pc, small box
- supported OS: Android, iOS
- compatibility: EMOS GoSmart, TUYA, LIDL, Smartlife
- protocol: Wi-Fi
- control by voice assistants
- notifications to the mobile app



ZQW832R 1/-/4/72
15 25 500 500 ZQW832R

- replacement of incandescent bulb: 60 W
- dimmable
- shape: A60
- luminous flux: 806 lm
- color temperature: 2 700–6 500 K
- power: 9 W
- luminous efficacy: 90 lm/W
- energy efficiency class: F
- beam angle: 200°

- color rendering index (CRI): Ra >80
- voltage: 230 V~/50 Hz
- dimensions: 60 × 60 × 120 mm
- packaging: 1 pc, small box
- supported OS: Android, iOS
- compatibility: EMOS GoSmart, TUYA, LIDL, Smartlife
- protocol: Zigbee 3.0
- control by voice assistants
- notifications to the mobile app



ZQZ514R 1/-/10/40
15 25 753 500 ZQZ514R

- replacement of incandescent bulb: 75 W
- dimmable
- shape: A60
- luminous flux: 1 050 lm
- color temperature: 2 700–6 500 K
- power: 11 W
- luminous efficacy: 95 lm/W
- energy efficiency class: F
- beam angle: 200°

- color rendering index (CRI): Ra >80
- voltage: 230 V~/50 Hz
- dimensions: 60 × 60 × 125 mm
- packaging: 1 pc, small box
- supported OS: Android, iOS
- compatibility: EMOS GoSmart, TUYA, LIDL, Smartlife
- protocol: Zigbee 3.0
- control by voice assistants
- notifications to the mobile app

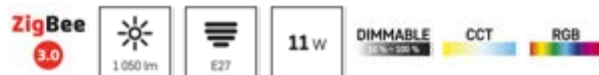

ZQZ515R 1/-/10/40
15 25 753 501 ZQZ515R

- replacement of incandescent bulb: 94 W
- dimmable
- shape: A65
- luminous flux: 1 400 lm
- color temperature: 2 700–6 500 K
- power: 14 W
- luminous efficacy: 100 lm/W
- energy efficiency class: F
- beam angle: 200°

- color rendering index (CRI): Ra >80
- voltage: 230 V~/50 Hz
- dimensions: 65 × 65 × 134 mm
- packaging: 1 pc, small box
- supported OS: Android, iOS
- compatibility: EMOS GoSmart, TUYA, LIDL, Smartlife
- protocol: Zigbee 3.0
- control by voice assistants
- notifications to the mobile app



ZQZ516R 1/-/10/40
15 25 753 502 ZQZ516R

- replacement of incandescent bulb: 40 W
- dimmable
- shape: Candle
- luminous flux: 470 lm
- color temperature: 2 700–6 500 K
- power: 4.8 W
- luminous efficacy: 98 lm/W
- energy efficiency class: F
- beam angle: 180°

- color rendering index (CRI): Ra >80
- voltage: 230 V~/50 Hz
- dimensions: 37 × 37 × 110 mm
- packaging: 1 pc, small box
- supported OS: Android, iOS
- compatibility: EMOS GoSmart, TUYA, LIDL, Smartlife
- protocol: Zigbee 3.0
- control by voice assistants
- notifications to the mobile app



ZQZ322R 1/-/10/60
15 25 751 500 ZQZ322R



www.emos.eu

Order Code
Item Number

Packaging
Type

- replacement of incandescent bulb: 35 W
- dimmable
- shape: MR16
- luminous flux: 400 lm
- color temperature: 2 700-6 500 K
- power: 4.8 W
- luminous efficacy: 83 lm/W
- energy efficiency class: G
- beam angle: 120°
- color rendering index (CRI): Ra >80
- voltage: 230 V~/50 Hz
- dimensions: 50 × 50 × 56.5 mm
- packaging: 1 pc, small box
- supported OS: Android, iOS
- compatibility: EMOS GoSmart, TUYA, LIDL, Smartlife
- protocol: Zigbee 3.0
- control by voice assistants
- notifications to the mobile app



ZQZ832R 1/-/4/72
15 25 750 500 ZQZ832R

Light sources

Light bulbs for electrical appliances

- energy-saving LED and classic bulbs for kitchen appliances
- shape adapted for use in various household appliances
- with E14 lamp cap
- bulb for oven, can withstand up to 300 °C

- replacement of incandescent bulb: 17 W
- shape: ST26
- luminous flux: 160 lm
- color temperature: 4 000 K
- power: 1.8 W
- luminous efficacy: 89 lm/W
- energy efficiency class: F
- beam angle: 150°
- color rendering index (CRI): Ra >80
- voltage: 230 V~/50 Hz
- dimensions: 58 × 27 × 27 mm
- packaging: 1 pc, small box



Z6913 1/-/10/100
15 24 014 013 LED-FR-1,6W-NW

- replacement of incandescent bulb: 40 W
- shape: JC
- luminous flux: 465 lm
- color temperature: 3 000 K
- power: 4.5 W
- luminous efficacy: 103 lm/W
- energy efficiency class: F
- beam angle: 300°
- color rendering index (CRI): Ra >80
- voltage: 230 V~/50 Hz
- dimensions: 58 × 20 × 20 mm
- packaging: 1 pc, small box



ZQ9140 1/-/10/60
15 25 731 208 ZQ9140

- replacement of incandescent bulb: 40 W
- shape: JC
- luminous flux: 465 lm
- color temperature: 4 000 K
- power: 4.5 W
- luminous efficacy: 103 lm/W
- energy efficiency class: F
- beam angle: 300°
- color rendering index (CRI): Ra >80

- voltage: 230 V~/50 Hz
- dimensions: 58 × 20 × 20 mm
- packaging: 1 pc, small box



ZQ9141 1/-/10/60
15 25 731 407 ZQ9141

- type: special lamp for oven
- voltage: 230 V
- power: 15 W
- color temperature: 300 °C
- socket (bulb holder): E14
- luminous flux: 58 lm
- packaging: 1 pc, box
- dimensions: 23 × 45 mm



Z6911 1/-/10/300
15 24 115 010 Z2

- type: fume hood bulb
- voltage: 230 V
- power: 40 W
- socket (bulb holder): E14
- luminous flux: 400 lm
- packaging: 1 pc, box
- dimensions: 25 × 82 mm



C5109 1/-/-/100
31 32 510 900 ADR 230-240V
40W/E14

ECO halogen

- more energy-efficient version of classic tungsten fibre bulb
- lights up to 100 % immediately after pressing the switch
- smooth dimming capability (when used with suitable dimmer)

- replacement of incandescent bulb: 94 W
- dimmable
- shape: J78
- luminous flux: 1 400 lm
- color temperature: 3 000 K
- power: 80 W
- luminous efficacy: 18 lm/W
- energy efficiency class: G
- beam angle: 360°

- color rendering index (CRI): Ra >99
- voltage: 230 V~/50 Hz
- dimensions: 8 × 78 × 8 mm
- packaging: 1 pc, small box



ZE0101 1/10/50/500
15 27 000 800 ECL 80-J78

- replacement of incandescent bulb: 139 W
- dimmable
- shape: J78
- luminous flux: 2 250 lm
- color temperature: 3 000 K
- power: 120 W
- luminous efficacy: 19 lm/W
- energy efficiency class: G
- beam angle: 360°
- color rendering index (CRI): Ra >99
- voltage: 230 V~/50 Hz
- dimensions: 8 × 78 × 8 mm
- packaging: 1 pc, small box



ZE0102 1/10/50/500
15 27 001 200 ECL 120-J78

- replacement of incandescent bulb: 161 W
- dimmable
- shape: J118
- luminous flux: 2 680 lm
- color temperature: 3 000 K
- power: 140 W
- luminous efficacy: 19 lm/W
- energy efficiency class: G
- beam angle: 360°
- color rendering index (CRI): Ra >99
- voltage: 230 V~/50 Hz
- dimensions: 10 × 118 × 10 mm
- packaging: 1 pc, small box



ZE0203 1/10/50/250
15 27 101 400 ZE0203

Light sources

LED tubes, tubes

PROFI PLUS

- designed for professional replacement of fluorescent tubes
- high luminous efficacy up to 150 lm/W
- high energy saving
- increased service life
- 5 years warranty
- use: administrative and industrial premises

- shape: T8
- luminous flux: 1 100 lm
- color temperature: 4 000 K
- power: 7.3 W
- luminous efficacy: 151 lm/W
- energy efficiency class: D
- beam angle: 260°
- color rendering index (CRI): Ra >80
- voltage: 230 V~/50 Hz
- dimensions: 27 × 603 × 27 mm
- packaging: 10 pcs, small box



Z73215 10/-/-/10
15 35 235 000 Z73215

- shape: T8
- luminous flux: 1 100 lm
- color temperature: 6 500 K
- power: 7.3 W
- luminous efficacy: 151 lm/W
- energy efficiency class: D
- beam angle: 260°
- color rendering index (CRI): Ra >80
- voltage: 230 V~/50 Hz

- dimensions: 27 × 603 × 27 mm
- packaging: 10 pcs, small box



Z73216 10/-/-/10
15 35 236 000 Z73216

- shape: T8
- luminous flux: 2 100 lm
- color temperature: 4 000 K
- power: 14 W
- luminous efficacy: 150 lm/W
- energy efficiency class: D
- beam angle: 260°
- color rendering index (CRI): Ra >80
- voltage: 230 V~/50 Hz

- dimensions: 27 × 1213 × 27 mm
- packaging: 10 pcs, small box



Z73225 10/-/-/10
15 35 237 000 Z73225

- shape: T8
- luminous flux: 2 100 lm
- color temperature: 6 500 K
- power: 14 W
- luminous efficacy: 150 lm/W
- energy efficiency class: D
- beam angle: 260°
- color rendering index (CRI): Ra >80
- voltage: 230 V~/50 Hz

- dimensions: 27 × 1213 × 27 mm
- packaging: 10 pcs, small box



Z73226 10/-/-/10
15 35 238 000 Z73226

- shape: T8
- luminous flux: 3 100 lm
- color temperature: 4 000 K
- power: 20.6 W
- luminous efficacy: 150 lm/W
- energy efficiency class: D
- beam angle: 260°
- color rendering index (CRI): Ra >80
- voltage: 230 V~/50 Hz

- dimensions: 27 × 1514 × 27 mm
- packaging: 10 pcs, small box



Z73235 10/-/-/10
15 35 239 000 Z73235

- shape: T8
- luminous flux: 3 100 lm
- color temperature: 6 500 K
- power: 20.6 W
- luminous efficacy: 150 lm/W
- energy efficiency class: D
- beam angle: 260°
- color rendering index (CRI): Ra >80
- voltage: 230 V~/50 Hz

- dimensions: 27 × 1514 × 27 mm
- packaging: 10 pcs, small box



Z73236 10/-/-/10
15 35 240 000 Z73236

BASIC

- designed to replace conventional fluorescent tubes
- they are characterized by luminous efficacy up to 100 lm/W
- high energy saving
- long service life
- favourable price/quality ratio
- use: administrative and industrial premises

- shape: T8
- luminous flux: 900 lm
- color temperature: 4 000 K
- power: 9.4 W
- luminous efficacy: 96 lm/W
- energy efficiency class: F
- beam angle: 260°
- color rendering index (CRI): Ra >80
- voltage: 230 V~/50 Hz
- dimensions: 600 × 26 × 26 mm
- packaging: 25 pc, small box



Z73113 25/-/-/25
15 35 241 000 Z73113



- shape: T8
- luminous flux: 900 lm
- color temperature: 6 500 K
- power: 9.4 W
- luminous efficacy: 96 lm/W
- energy efficiency class: F
- beam angle: 260°
- color rendering index (CRI): Ra >80
- voltage: 230 V~/50 Hz
- dimensions: 600 × 26 × 26 mm
- packaging: 25 pc, small box



Z73114 25/-/-/25
15 35 242 000 Z73114



- shape: T8
- luminous flux: 1 800 lm
- color temperature: 4 000 K
- power: 17.8 W
- luminous efficacy: 101 lm/W
- energy efficiency class: F
- beam angle: 260°
- color rendering index (CRI): Ra >80
- voltage: 230 V~/50 Hz
- dimensions: 1 200 × 26 × 26 mm
- packaging: 25 pc, small box



Z73123 25/-/-/25
15 35 243 000 Z73123



- shape: T8
- luminous flux: 1 800 lm
- color temperature: 6 500 K
- power: 17.8 W
- luminous efficacy: 101 lm/W
- energy efficiency class: F
- beam angle: 260°
- color rendering index (CRI): Ra >80
- voltage: 230 V~/50 Hz
- dimensions: 1 200 × 26 × 26 mm
- packaging: 25 pc, small box



Z73124 25/-/-/25
15 35 244 000 Z73124



- shape: T8
- luminous flux: 2 500 lm
- color temperature: 4 000 K
- power: 24.3 W
- luminous efficacy: 103 lm/W
- energy efficiency class: F
- beam angle: 260°
- color rendering index (CRI): Ra >80
- voltage: 230 V~/50 Hz
- dimensions: 1 500 × 26 × 26 mm
- packaging: 25 pc, small box

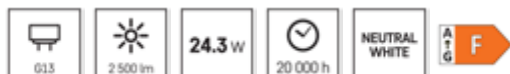

Z73133 25/-/-/25
15 35 245 000 Z73133

- shape: T8
- luminous flux: 2 500 lm
- color temperature: 6 500 K
- power: 24.3 W
- luminous efficacy: 103 lm/W
- energy efficiency class: F
- beam angle: 260°
- color rendering index (CRI): Ra >80
- voltage: 230 V~/50 Hz
- dimensions: 1 500 × 26 × 26 mm
- packaging: 25 pc, small box



Z73134 25/-/-/25
15 35 246 000 Z73134

Luminaires

Highbays

PROFI PLUS

ASTER

PROFI PLUS

- for professional industrial installations at high heights
- Osram branded LED chips with a luminous efficacy of 180 lm/W
- IP65 rating ensures water resistance
- outstanding performance and light quality – CRI > 80
- option for dimming using accessories
- 5 years warranty
- use: industrial and warehouse buildings, large halls

- power: 100 W
- luminous flux: 18 000 lm
- color temperature: 4 000 K
- light color: neutral white
- color rendering index (CRI): Ra > 80
- voltage: 220–240 V~
- IP rating: IP65
- beam angle: 60°
- dimensions: 265 × 163 mm in diameter
- supply cable length: 30 cm
- lead-in cable material: rubber
- body material: aluminum
- mechanical impact protection: IK08
- packaging: 1 pc, box



ZU310.6 1/-/-/1
15 46 139 000 ZU310.6

- power: 100 W
- luminous flux: 18 000 lm
- color temperature: 4 000 K
- light color: neutral white
- color rendering index (CRI): Ra > 80
- voltage: 220-240 V~
- IP rating: IP65
- beam angle: 90°
- dimensions: 265 × 163 mm in diameter

- supply cable length: 30 cm
- lead-in cable material: rubber
- body material: aluminum
- mechanical impact protection: IK08
- packaging: 1 pc, box



ZU310.9 1/-/-/1
15 46 139 100 ZU310.9

- power: 100 W
- luminous flux: 18 000 lm
- color temperature: 4 000 K
- light color: neutral white
- color rendering index (CRI): Ra > 80
- voltage: 220-240 V~
- IP rating: IP65
- beam angle: 120°
- dimensions: 265 × 163 mm in diameter

- supply cable length: 30 cm
- lead-in cable material: rubber
- body material: aluminum
- mechanical impact protection: IK08
- packaging: 1 pc, box



ZU310.12 1/-/-/1
15 46 139 200 ZU310.12

- power: 150 W
- luminous flux: 27 000 lm
- color temperature: 4 000 K
- light color: neutral white
- color rendering index (CRI): Ra > 80
- voltage: 220-240 V~
- IP rating: IP65
- beam angle: 60°
- dimensions: 300 × 173 mm in diameter

- supply cable length: 30 cm
- lead-in cable material: rubber
- body material: aluminum
- mechanical impact protection: IK08
- packaging: 1 pc, box



ZU315.6 1/-/-/1
15 46 139 300 ZU315.6

- power: 150 W
- luminous flux: 27 000 lm
- color temperature: 4 000 K
- light color: neutral white
- color rendering index (CRI): Ra > 80
- voltage: 220-240 V~
- IP rating: IP65
- beam angle: 90°
- dimensions: 300 × 173 mm in diameter

- supply cable length: 30 cm
- lead-in cable material: rubber
- body material: aluminum
- mechanical impact protection: IK08
- packaging: 1 pc, box



ZU315.9 1/-/-/1
15 46 139 400 ZU315.9

- power: 150 W
- luminous flux: 27 000 lm
- color temperature: 4 000 K
- light color: neutral white
- color rendering index (CRI): Ra > 80
- voltage: 220-240 V~
- IP rating: IP65
- beam angle: 120°
- dimensions: 300 × 173 mm in diameter

- supply cable length: 30 cm
- lead-in cable material: rubber
- body material: aluminum
- mechanical impact protection: IK08
- packaging: 1 pc, box



ZU315.12 1/-/-/1
15 46 139 500 ZU315.12



www.emos.eu

Order Code
Item Number

Packaging
Type

- power: 200 W
- luminous flux: 36 000 lm
- color temperature: 4 000 K
- light color: neutral white
- color rendering index (CRI): Ra > 80
- voltage: 220-240 V~
- IP rating: IP65
- beam angle: 60°
- dimensions: 340 × 178 mm in diameter
- supply cable length: 30 cm
- lead-in cable material: rubber
- body material: aluminum
- mechanical impact protection: IK08
- packaging: 1 pc, box



200 W	36 000 lm	IP65	IK08	60°	4 000 K NEUTRAL WHITE	5 YEARS WARRANTY
-------	-----------	------	------	-----	-----------------------------	------------------------



ZU320.6	1/-/-/1
15 46 139 600	ZU320.6

- power: 200 W
- luminous flux: 36 000 lm
- color temperature: 4 000 K
- light color: neutral white
- color rendering index (CRI): Ra > 80
- voltage: 220-240 V~
- IP rating: IP65
- beam angle: 90°
- dimensions: 340 × 178 mm in diameter
- supply cable length: 30 cm
- lead-in cable material: rubber
- body material: aluminum
- mechanical impact protection: IK08
- packaging: 1 pc, box



200 W	36 000 lm	IP65	IK08	90°	4 000 K NEUTRAL WHITE	5 YEARS WARRANTY
-------	-----------	------	------	-----	-----------------------------	------------------------



ZU320.9	1/-/-/1
15 46 139 700	ZU320.9

- power: 200 W
- luminous flux: 36 000 lm
- color temperature: 4 000 K
- light color: neutral white
- color rendering index (CRI): Ra > 80
- voltage: 220-240 V~
- IP rating: IP65
- beam angle: 120°
- dimensions: 340 × 178 mm in diameter
- supply cable length: 30 cm
- lead-in cable material: rubber
- body material: aluminum
- mechanical impact protection: IK08
- packaging: 1 pc, box



200 W	36 000 lm	IP65	IK08	120°	4 000 K NEUTRAL WHITE	5 YEARS WARRANTY
-------	-----------	------	------	------	-----------------------------	------------------------



ZU320.12	1/-/-/1
15 46 139 800	ZU320.12

Luminaires

Highbays

PROFI

CORUS

PROFI

- for industrial installations at high heights
- IP65 rating ensures water resistance
- outstanding performance and light quality – CRI > 80
- 5 years warranty
- use: industrial and warehouse buildings, large halls

- power: 83 W
- luminous flux: 10 000 lm
- color temperature: 4 000 K
- light color: neutral white
- color rendering index (CRI): Ra > 80
- voltage: 220–240 V
- IP rating: IP65
- beam angle: 110°
- dimensions: diameter 220 × 50 mm

- supply cable length: 30 cm
- lead-in cable material: rubber
- body material: aluminum
- mechanical impact protection: IK06
- packaging: 1 pc, box

**ZU083**

1/-/-/3

15 46 138 000

ZU083

- power: 133 W
- luminous flux: 16 000 lm
- color temperature: 4 000 K
- light color: neutral white
- color rendering index (CRI): Ra > 80
- voltage: 220–240 V
- IP rating: IP65
- beam angle: 110°
- dimensions: diameter 260 × 53 mm

- supply cable length: 30 cm
- lead-in cable material: rubber
- body material: aluminum
- mechanical impact protection: IK06
- packaging: 1 pc, box

**ZU133**

1/-/-/3

15 46 138 100

ZU133

- power: 166 W
- luminous flux: 20 000 lm
- color temperature: 4 000 K
- light color: neutral white
- color rendering index (CRI): Ra > 80
- voltage: 220–240 V
- IP rating: IP65
- beam angle: 110°
- dimensions: diameter 300 × 54 mm

- supply cable length: 30 cm
- lead-in cable material: rubber
- body material: aluminum
- mechanical impact protection: IK06
- packaging: 1 pc, box

**ZU166**

1/-/-/3

15 46 138 200

ZU166

- power: 225 W
- luminous flux: 27 000 lm
- color temperature: 4 000 K
- light color: neutral white
- color rendering index (CRI): Ra > 80
- voltage: 220-240 V
- IP rating: IP65
- beam angle: 110°
- dimensions: diameter 340 × 54 mm
- supply cable length: 30 cm
- lead-in cable material: rubber
- body material: aluminum
- mechanical impact protection: IK06
- packaging: 1 pc, box



ZU225 1/-/-/3
15 46 138 300 ZU225

Luminaires

Highbays

Accessories

ZU9001 1/-/-/144
15 46 009 001 ZU9001





product: 0-10 V converter for Highbay = dimensions: 55 × 29 mm in diameter = material: plastic (PC) + metal = designed for: Highbay line ASTER = packaging: 1 ks, box



ZU9002 1/-/-/144
15 46 009 002 ZU9002





product: DALI converter for Highbay = dimensions: 55 × 29 mm in diameter = material: plastic (PC) + metal = designed for: Highbay line ASTER = packaging: 1 ks, box

ZU9902 1/-/-/20
15 46 009 902 ZU9902

product: bracket for Highbay = dimensions: 254 × 115 × 50 mm = material: aluminum = designed for: Highbay line ASTER = color: black = packaging: 1 pc, packet

ZU9003 1/-/-/96
15 46 009 003 ZU9003





product: PIR sensor for highbay ASTER = dimensions: diameter 55 × 40 mm = material: plastic (PC) + metal = designed for: Highbay line ASTER = color: white = packaging: 1 ks, box

ZU9004 1/-/-/144
15 46 009 004 ZU9004





product: MW sensor for highbay ASTER = dimensions: 55 × 29 mm in diameter = material: plastic (PC) + metal = designed for: Highbay line ASTER = color: white = packaging: 1 ks, box

ZU9005 1/-/-/81
15 46 009 005 ZU9005





product: sensor settings controller for Highbay ASTER = dimensions: 125 × 70 × 25 mm = material: plastic = designed for: Highbay line ASTER = color: white = packaging: 1 ks, box

Luminaires

Dustproofs

PROFI PLUS

MISTY

PROFI PLUS

- designed for professional industrial installations
- replace older fluorescent luminaires
- modern design with high luminous efficacy up to 145 lm/W
- long life and instant 100% output
- energy saving up to 50% compared to fluorescent luminaires
- IP66 protection guarantees water resistance
- 5 years warranty
- use: industrial buildings, garages, corridors, workshops

- dimensions: 1 220 × 85 × 80 mm
- power: 21–26–31–35 W
- luminous flux: 3 300–5 600 lm
- color temperature: 4 000 K
- color rendering index (CRI): Ra >80
- beam angle: 120°
- IP rating: IP66
- through-wiring
- working temperature range: -20 °C to +40 °C

- clip material: stainless steel
- voltage: 220–240 V
- protection class: I
- packaging: 1 pc, box









ZT1521 1/-/-/9
15 46 138 400 ZT1521

- dimensions: 1 220 × 85 × 80 mm
- power: 24–29–34–38 W
- luminous flux: 3 300–5 600 lm
- color temperature: 4 000–6 500 K
- color rendering index (CRI): Ra >80
- beam angle: 120°
- IP rating: IP66
- through-wiring
- working temperature range: -20 °C to +40 °C

- clip material: stainless steel
- voltage: 220–240 V
- protection class: I
- lumen output in emergency mode: 700 lm
- backup time: 3 hours
- battery warranty: 2 years
- packaging: 1 pc, box











ZT1521E 1/-/-/9
15 46 138 401 ZT1521E



www.emos.eu

Order Code
Item Number

Packaging
Type

- dimensions: 1 220 × 85 × 80 mm
- power: 21–26–31–35 W
- luminous flux: 3 300–5 600 lm
- color temperature: 6 500 K
- color rendering index (CRI): Ra >80
- beam angle: 120°
- IP rating: IP66
- through-wiring
- working temperature range: -20 °C to +40 °C

- clip material: stainless steel
- voltage: 220–240 V
- protection class: I
- packaging: 1 pc, box



ZT1531 1/-/-/9
15 46 138 500 ZT1531

- dimensions: 1 520 × 85 × 80 mm
- power: 29–37–45–51 W
- luminous flux: 4 600–8 150 lm
- color temperature: 4 000 K
- color rendering index (CRI): Ra >80
- beam angle: 120°
- IP rating: IP66
- through-wiring
- working temperature range: -20 °C to +40 °C

- clip material: stainless steel
- voltage: 220–240 V
- protection class: I
- packaging: 1 pc, box



ZT1621 1/-/-/9
15 46 138 600 ZT1621

- dimensions: 1 520 × 85 × 80 mm
- power: 32–40–48–54 W
- luminous flux: 4 600–8 150 lm
- color temperature: 4 000–6 500 K
- color rendering index (CRI): Ra >80
- beam angle: 120°
- IP rating: IP66
- through-wiring
- working temperature range: -20 °C to +40 °C

- clip material: stainless steel
- voltage: 220–240 V
- protection class: I
- lumen output in emergency mode: 700 lm
- backup time: 3 hours
- battery warranty: 2 years
- packaging: 1 pc, box



ZT1621E 1/-/-/9
15 46 138 601 ZT1621E

- dimensions: 1 520 × 85 × 80 mm
- power: 29–37–45–51 W
- luminous flux: 4 600–8 150 lm
- color temperature: 6 500 K
- color rendering index (CRI): Ra >80
- beam angle: 120°
- IP rating: IP66
- through-wiring
- working temperature range: -20 °C to +40 °C

- clip material: stainless steel
- voltage: 220–240 V
- protection class: I
- packaging: 1 pc, box



ZT1631 1/-/-/9
15 46 138 700 ZT1631

- dimensions: 670 × 85 × 80 mm
- power: 10–13–16–18 W
- luminous flux: 1 500–2 700 lm
- color temperature: 4 000–6 500 K
- color rendering index (CRI): Ra >80
- beam angle: 120°
- IP rating: IP66
- through-wiring
- working temperature range: -20 °C to +40 °C

- clip material: stainless steel
- voltage: 220–240 V
- protection class: I
- packaging: 1 pc, box



ZT1040 1/-/-/12
15 46 138 800 ZT1040

Luminaires

Dustproofs

PROFI

FESTY

PROFI

- designed for professional industrial installations
- replace older fluorescent luminaires
- characterised by their modern design
- excellent price/quality ratio
- long life and instant 100% output
- energy saving up to 50% compared to fluorescent luminaires
- 5 years warranty
- use: industrial buildings, garages, corridors, workshops

- dimensions: 670 × 64 × 64 mm
- power: 18 W
- luminous flux: 2 200 lm
- color temperature: 4 000 K
- color rendering index (CRI): Ra >80
- beam angle: 120°
- IP rating: IP65
- through-wiring
- working temperature range: -20 °C to +40 °C

- material: plastic (PC)
- clip material: no clips
- voltage: 220–240 V
- protection class: I
- packaging: 1 pc, box



ZT4320 1/-/-/10
15 46 137 700 ZT4320

- dimensions: 1 270 × 64 × 64 mm
- power: 34 W
- luminous flux: 4 100 lm
- color temperature: 4 000 K
- color rendering index (CRI): Ra >80
- beam angle: 120°
- IP rating: IP65
- through-wiring
- working temperature range: -20 °C to +40 °C

- material: plastic (PC)
- clip material: no clips
- voltage: 220–240 V
- protection class: I
- packaging: 1 pc, box



ZT4420 1/-/-/10
15 46 137 800 ZT4420

- dimensions: 1 570 × 64 × 64 mm
- power: 51 W
- luminous flux: 6 000 lm
- color temperature: 4 000 K
- color rendering index (CRI): Ra >80
- beam angle: 120°
- IP rating: IP65
- through-wiring
- working temperature range: -20 °C to +40 °C

- material: plastic (PC)
- clip material: no clips
- voltage: 220–240 V
- protection class: I
- packaging: 1 pc, box



ZT4520 1/-/-/10
15 46 137 900 ZT4520

Luminaires

Dustproofs

ESSENTIAL

DUSTY

ESSENTIAL

- designed for standard industrial installations
- replace older fluorescent luminaires
- long life and instant 100% output
- energy saving up to 50% compared to fluorescent luminaires
- IP65 protection guarantees water resistance
- possibility of through wiring
- 3 years warranty
- use: industrial buildings, garages, corridors, workshops

- dimensions: 754 × 53 × 35 mm
- power: 18 W
- luminous flux: 1 700 lm
- color temperature: 4 000 K
- color rendering index (CRI): Ra >80
- beam angle: 120°
- IP rating: IP65
- through-wiring
- working temperature range: -15 °C to +35 °C

- material: plastic (PC)
- clip material: no clips
- voltage: 220–240 V
- protection class: II
- packaging: 1 pc, blister



ZT3020 1/-/-/20
15 46 135 700 ZT3020

- dimensions: 1 284 × 53 × 35 mm
- power: 37 W
- luminous flux: 3 800 lm
- color temperature: 4 000 K
- color rendering index (CRI): Ra >80
- beam angle: 120°
- IP rating: IP65
- through-wiring
- working temperature range: -15 °C to +35 °C

- material: plastic (PC)
- clip material: no clips
- voltage: 220–240 V
- protection class: II
- packaging: 1 pc, blister



ZT3120 1/-/-/20
15 46 135 800 ZT3120

- dimensions: 1 564 × 53 × 35 mm
- power: 45 W
- luminous flux: 4 500 lm
- color temperature: 4 000 K
- color rendering index (CRI): Ra >80
- beam angle: 120°
- IP rating: IP65
- through-wiring
- working temperature range: -20 °C to +35 °C

- material: plastic (PC)
- clip material: no clips
- voltage: 220–240 V
- protection class: II
- packaging: 1 pc, blister



ZT3220 1/-/-/20
15 46 135 900 ZT3220

Luminaires

Street Lights

PROFI

SOLIS

PROFI

- street lights
- durable aluminium body
- lighting efficiency up to 120 lm/W
- high operating cost savings compared to sodium lamps
- 3 years warranty
- use: permanent outdoor lighting

- power: 30 W
- luminous flux: 3 600 lm
- color temperature: 3 000 K
- light color: warm white
- color rendering index (CRI): Ra > 80
- voltage: 220–240 V
- IP rating: IP65
- beam angle: 130 × 60°
- dimensions: 412 × 146 × 63 mm

- supply cable length: 30 cm
- lead-in cable material: rubber
- body material: aluminum
- mechanical impact protection: IK08
- packaging: 1 pc, box

**Z00303**

1/-/-/4

15 36 000 000

Z00303

- power: 30 W
- luminous flux: 3 600 lm
- color temperature: 4 000 K
- light color: neutral white
- color rendering index (CRI): Ra > 80
- voltage: 220–240 V
- IP rating: IP65
- beam angle: 130 × 60°
- dimensions: 412 × 146 × 63 mm

- supply cable length: 30 cm
- lead-in cable material: rubber
- body material: aluminum
- mechanical impact protection: IK08
- packaging: 1 pc, box

**Z00304**

1/-/-/4

15 36 020 000

Z00304

- power: 50 W
- luminous flux: 6 000 lm
- color temperature: 4 000 K
- light color: neutral white
- color rendering index (CRI): Ra > 80
- voltage: 220–240 V
- IP rating: IP65
- beam angle: 130 × 60°
- dimensions: 412 × 146 × 63 mm

- supply cable length: 30 cm
- lead-in cable material: rubber
- body material: aluminum
- mechanical impact protection: IK08
- packaging: 1 pc, box

**Z00504**

1/-/-/4

15 36 020 001

Z00504



www.emos.eu

Order Code
Item Number

Packaging
Type

- power: 70 W
- luminous flux: 8 400 lm
- color temperature: 4 000 K
- light color: neutral white
- color rendering index (CRI): Ra > 80
- voltage: 220-240 V
- IP rating: IP65
- beam angle: 130 × 60°
- dimensions: 515 × 175 × 63 mm
- supply cable length: 30 cm
- lead-in cable material: rubber
- body material: aluminum
- mechanical impact protection: IK08
- packaging: 1 pc, box



Z00704 1/-/-/2
15 36 020 002 Z00704

Luminaires

Floodlights

PROFI PLUS

AVENO

PROFI PLUS

- combine top performance with a modern look
- provide a luminous efficiency of up to 160 lm/W
- the robust and well-made aluminium body
- adjustable wattage on selected models
- cost savings of up to 90% compared to halogen floodlights
- continuously dimmable
- 5 years warranty
- use: permanent illumination of indoor and outdoor areas

- power: 20 W
- luminous flux: 2 900 lm
- color temperature: 4 000 K
- light color: neutral white
- color rendering index (CRI): Ra > 80
- voltage: 220-240 V
- IP rating: IP66
- beam angle: 100°
- dimensions: 175 × 165 × 34 mm
- supply cable length: 1 m
- lead-in cable material: rubber
- body material: aluminum
- mechanical impact protection: IK08
- packaging: 1 pc, box



ZS2413 1/-/-/10
15 31 241 300 ZS2413

- power: 30 W
- luminous flux: 4 500 lm
- color temperature: 4 000 K
- light color: neutral white
- color rendering index (CRI): Ra > 80
- voltage: 220-240 V
- IP rating: IP66
- beam angle: 100°
- dimensions: 196 × 183 × 37 mm
- supply cable length: 1 m
- lead-in cable material: rubber
- body material: aluminum
- mechanical impact protection: IK08
- packaging: 1 pc, box



ZS2423 1/-/-/10
15 31 242 300 ZS2423

- power: 48 W
- luminous flux: 7 200 lm
- color temperature: 4 000 K
- light color: neutral white
- color rendering index (CRI): Ra > 80
- voltage: 220-240 V
- IP rating: IP66
- beam angle: 100°
- dimensions: 247 × 183 × 37 mm

- supply cable length: 1 m
- lead-in cable material: rubber
- body material: aluminum
- mechanical impact protection: IK08
- packaging: 1 pc, box



ZS2433 1/-/-10
15 31 243 300 ZS2433

- power: 100 W
- luminous flux: 16 000 lm
- color temperature: 4 000 K
- light color: neutral white
- color rendering index (CRI): Ra > 80
- voltage: 100-277 V
- IP rating: IP66
- beam angle: 90°
- dimensions: 294 × 270 × 70 mm

- supply cable length: 1 m
- lead-in cable material: rubber
- body material: aluminum
- mechanical impact protection: IK08
- packaging: 1 pc, box



ZS2443 1/-/-1
15 31 244 300 ZS2443

- power: 100 W
- luminous flux: 15 500 lm
- color temperature: 4 000 K
- light color: neutral white
- color rendering index (CRI): Ra > 80
- voltage: 100-277 V
- IP rating: IP66
- beam angle: 60° × 135°
- dimensions: 294 × 270 × 70 mm

- supply cable length: 1 m
- lead-in cable material: rubber
- body material: aluminum
- mechanical impact protection: IK08
- packaging: 1 pc, box



ZS2443A 1/-/-1
15 31 244 310 ZS2443A

- power: 150 W
- luminous flux: 24 000 lm
- color temperature: 4 000 K
- light color: neutral white
- color rendering index (CRI): Ra > 80
- voltage: 100-277 V
- IP rating: IP66
- beam angle: 90°
- dimensions: 294 × 345 × 70 mm

- supply cable length: 1 m
- lead-in cable material: rubber
- body material: aluminum
- mechanical impact protection: IK08
- packaging: 1 pc, box



ZS2453 1/-/-1
15 31 245 300 ZS2453

- power: 150 W
- luminous flux: 23 250 lm
- color temperature: 4 000 K
- light color: neutral white
- color rendering index (CRI): Ra > 80
- voltage: 100-277 V
- IP rating: IP66
- beam angle: 60° × 135°
- dimensions: 294 × 345 × 70 mm

- supply cable length: 1 m
- lead-in cable material: rubber
- body material: aluminum
- mechanical impact protection: IK08
- packaging: 1 pc, box



ZS2453A 1/-/-1
15 31 245 310 ZS2453A



www.emos.eu

Order Code
Item Number

Packaging
Type

- power: 200 W
- luminous flux: 32 000 lm
- color temperature: 4 000 K
- light color: neutral white
- color rendering index (CRI): Ra > 80
- voltage: 100-277 V
- IP rating: IP66
- beam angle: 90°
- dimensions: 368 × 388 × 75 mm
- supply cable length: 1 m
- lead-in cable material: rubber
- body material: aluminum
- mechanical impact protection: IK08
- packaging: 1 pc, box



200 W	32 000 lm	IP66	IK08	Dimmable	4 000 K NEUTRAL WHITE	5 YEARS WARRANTY
-------	-----------	------	------	----------	-----------------------------	------------------------



ZS2463	1/-/-/1
15 31 246 300	ZS2463

- power: 200 W
- luminous flux: 31 000 lm
- color temperature: 4 000 K
- light color: neutral white
- color rendering index (CRI): Ra > 80
- voltage: 100-277 V
- IP rating: IP66
- beam angle: 60° × 135°
- dimensions: 368 × 388 × 70 mm
- supply cable length: 1 m
- lead-in cable material: rubber
- body material: aluminum
- mechanical impact protection: IK08
- packaging: 1 pc, box



200 W	31 000 lm	IP66	IK08	Dimmable	4 000 K NEUTRAL WHITE	5 YEARS WARRANTY
-------	-----------	------	------	----------	-----------------------------	------------------------



ZS2463A	1/-/-/1
15 31 246 310	ZS2463A

- power: 300 W
- luminous flux: 48 000 lm
- color temperature: 4 000 K
- light color: neutral white
- color rendering index (CRI): Ra > 80
- voltage: 100-277 V
- IP rating: IP66
- beam angle: 90°
- dimensions: 432 × 425 × 75 mm
- supply cable length: 1 m
- lead-in cable material: rubber
- body material: aluminum
- mechanical impact protection: IK08
- packaging: 1 pc, box



300 W	48 000 lm	IP66	IK08	Dimmable	4 000 K NEUTRAL WHITE	5 YEARS WARRANTY
-------	-----------	------	------	----------	-----------------------------	------------------------



ZS2473	1/-/-/1
15 31 247 300	ZS2473

Luminaires

Floodlights

PROFI

INOVO

PROFI

- cost savings of up to 95% compared to halogen spotlights
- professional workmanship for the most demanding conditions
- easy cable connection using the cable connector (included)
- motion sensor with dimming and run time adjustment
- 5 years warranty
- use: permanent illumination of indoor and outdoor areas

- power: 10 W
- luminous flux: 1 100 lm
- color temperature: 4 000 K
- light color: neutral white
- color rendering index (CRI): Ra > 80
- voltage: 220-240 V~
- IP rating: IP65
- beam angle: 120°
- dimensions: 95 × 70 × 27 mm

- supply cable length: 30 cm
- lead-in cable material: rubber
- body material: aluminum
- mechanical impact protection: IK07
- packaging: 1 pc, box



ZS2612 1/-/-/30
15 31 242 612 ZS2612

- power: 20 W
- luminous flux: 2 200 lm
- color temperature: 4 000 K
- light color: neutral white
- color rendering index (CRI): Ra > 80
- voltage: 220-240 V~
- IP rating: IP65
- beam angle: 120°
- dimensions: 135 × 95 × 28 mm

- supply cable length: 30 cm
- lead-in cable material: rubber
- body material: aluminum
- mechanical impact protection: IK07
- packaging: 1 pc, box



ZS2622 1/-/-/20
15 31 242 622 ZS2622

- power: 30 W
- luminous flux: 3 300 lm
- color temperature: 4 000 K
- light color: neutral white
- color rendering index (CRI): Ra > 80
- voltage: 220-240 V~
- IP rating: IP65
- beam angle: 120°
- dimensions: 160 × 110 × 28 mm

- supply cable length: 30 cm
- lead-in cable material: rubber
- body material: aluminum
- mechanical impact protection: IK07
- packaging: 1 pc, box



ZS2632 1/-/-/10
15 31 242 632 ZS2632

- power: 50 W
- luminous flux: 5 500 lm
- color temperature: 4 000 K
- light color: neutral white
- color rendering index (CRI): Ra > 80
- voltage: 220-240 V~
- IP rating: IP65
- beam angle: 120°
- dimensions: 200 × 145 × 28 mm



- supply cable length: 30 cm
- lead-in cable material: rubber
- body material: aluminum
- mechanical impact protection: IK07
- packaging: 1 pc, box



ZS2642 1/-/-10
15 31 242 642 ZS2642

- power: 100 W
- luminous flux: 11 000 lm
- color temperature: 4 000 K
- light color: neutral white
- color rendering index (CRI): Ra > 80
- voltage: 220-240 V~
- IP rating: IP65
- beam angle: 120°
- dimensions: 300 × 220 × 42 mm



- supply cable length: 30 cm
- lead-in cable material: rubber
- body material: aluminum
- mechanical impact protection: IK08
- packaging: 1 pc, box



ZS2652 1/-/-5
15 31 242 652 ZS2652

- power: 150 W
- luminous flux: 16 500 lm
- color temperature: 4 000 K
- light color: neutral white
- color rendering index (CRI): Ra > 80
- voltage: 220-240 V~
- IP rating: IP65
- beam angle: 120°
- dimensions: 335 × 270 × 43 mm



- supply cable length: 30 cm
- lead-in cable material: rubber
- body material: aluminum
- mechanical impact protection: IK08
- packaging: 1 pc, box



ZS2662 1/-/-3
15 31 242 662 ZS2662

- power: 200 W
- luminous flux: 22 000 lm
- color temperature: 4 000 K
- light color: neutral white
- color rendering index (CRI): Ra > 80
- voltage: 220-240 V~
- IP rating: IP65
- beam angle: 120°
- dimensions: 390 × 300 × 49 mm



- supply cable length: 30 cm
- lead-in cable material: rubber
- body material: aluminum
- mechanical impact protection: IK08
- packaging: 1 pc, box



ZS2672 1/-/-2
15 31 242 672 ZS2672

- power: 10 W
- luminous flux: 1 100 lm
- color temperature: 4 000 K
- light color: neutral white
- color rendering index (CRI): Ra > 80
- voltage: 220-240 V~
- IP rating: IP65
- beam angle: 120°
- dimensions: 95 × 70 × 27 mm



- supply cable length: 30 cm
- detection range of PIR Sensor: 10 m
- lead-in cable material: rubber
- body material: aluminum
- mechanical impact protection: IK06
- packaging: 1 pc, box



ZS2712 1/-/-20
15 31 242 712 ZS2712

- power: 20 W
- luminous flux: 2 200 lm
- color temperature: 4 000 K
- light color: neutral white
- color rendering index (CRI): Ra > 80
- voltage: 220-240 V~
- IP rating: IP65
- beam angle: 120°
- dimensions: 135 × 95 × 28 mm

- supply cable length: 30 cm
- detection range of PIR Sensor: 10 m
- lead-in cable material: rubber
- body material: aluminum
- mechanical impact protection: IK06
- packaging: 1 pc, box



ZS2722 1/-/-20
15 31 242 722 ZS2722

- power: 30 W
- luminous flux: 3 300 lm
- color temperature: 4 000 K
- light color: neutral white
- color rendering index (CRI): Ra > 80
- voltage: 220-240 V~
- IP rating: IP65
- beam angle: 120°
- dimensions: 160 × 110 × 28 mm

- supply cable length: 30 cm
- detection range of PIR Sensor: 10 m
- lead-in cable material: rubber
- body material: aluminum
- mechanical impact protection: IK06
- packaging: 1 pc, box



ZS2732 1/-/-10
15 31 242 732 ZS2732

- power: 50 W
- luminous flux: 5 500 lm
- color temperature: 4 000 K
- light color: neutral white
- color rendering index (CRI): Ra > 80
- voltage: 220-240 V~
- IP rating: IP65
- beam angle: 120°
- dimensions: 200 × 145 × 28 mm

- supply cable length: 30 cm
- detection range of PIR Sensor: 10 m
- lead-in cable material: rubber
- body material: aluminum
- mechanical impact protection: IK06
- packaging: 1 pc, box



ZS2742 1/-/-10
15 31 242 742 ZS2742

Luminaires

Floodlights

CLASSIC

ILIO

CLASSIC

- unique design with a milky PC diffuser
- cost savings of up to 90% compared to halogen spotlights
- IP65 protection guarantees water resistance
- easy cable connection to the terminal block
- bevelled bracket allows easy installation on the wall
- 3 years warranty
- use: facades, private and public spaces, sales stands

- power: 10,5 W
- luminous flux: 950 lm
- color temperature: 4 000 K
- light color: neutral white
- color rendering index (CRI): Ra > 80
- voltage: 220–240 V~
- IP rating: IP65
- beam angle: 120°
- dimensions: 114 × 99 × 51 mm

- body material: aluminum
- mechanical impact protection: IK08
- packaging: 1 pc, box



ZS2510 1/-/-/20
15 31 252 510 ZS2510

- power: 21 W
- luminous flux: 1 900 lm
- color temperature: 4 000 K
- light color: neutral white
- color rendering index (CRI): Ra > 80
- voltage: 220–240 V~
- IP rating: IP65
- beam angle: 120°
- dimensions: 147 × 123 × 55 mm

- body material: aluminum
- mechanical impact protection: IK08
- packaging: 1 pc, box



ZS2520 1/-/-/20
15 31 252 520 ZS2520

- power: 31 W
- luminous flux: 2 800 lm
- color temperature: 4 000 K
- light color: neutral white
- color rendering index (CRI): Ra > 80
- voltage: 220–240 V~
- IP rating: IP65
- beam angle: 120°
- dimensions: 178 × 148 × 55 mm

- body material: aluminum
- mechanical impact protection: IK08
- packaging: 1 pc, box



ZS2530 1/-/-/12
15 31 252 530 ZS2530

- power: 51 W
- luminous flux: 4 600 lm
- color temperature: 4 000 K
- light color: neutral white
- color rendering index (CRI): Ra > 80
- voltage: 220-240 V~
- IP rating: IP65
- beam angle: 120°
- dimensions: 208 × 170 × 55 mm

- body material: aluminum
- mechanical impact protection: IK08
- packaging: 1 pc, box



ZS2540 1/-/-10
15 31 252 540 ZS2540

- power: 10,5 W
- luminous flux: 950 lm
- color temperature: 4 000 K
- light color: neutral white
- color rendering index (CRI): Ra > 80
- voltage: 220-240 V~
- IP rating: IP44
- beam angle: 120°
- dimensions: 114 × 162 × 75 mm

- detection range of PIR Sensor: 10 m
- body material: aluminum
- mechanical impact protection: IK06
- packaging: 1 pc, box



ZS2910 1/-/-18
15 31 252 910 ZS2910

- power: 21 W
- luminous flux: 1 900 lm
- color temperature: 4 000 K
- light color: neutral white
- color rendering index (CRI): Ra > 80
- voltage: 220-240 V~
- IP rating: IP44
- beam angle: 120°
- dimensions: 147 × 175 × 75 mm

- detection range of PIR Sensor: 10 m
- lead-in cable material: rubber
- body material: aluminum
- mechanical impact protection: IK06
- packaging: 1 pc, box



ZS2920 1/-/-12
15 31 252 920 ZS2920

- power: 31 W
- luminous flux: 2 800 lm
- color temperature: 4 000 K
- light color: neutral white
- color rendering index (CRI): Ra > 80
- voltage: 220-240 V~
- IP rating: IP44
- beam angle: 120°
- dimensions: 178 × 201 × 75 mm

- detection range of PIR Sensor: 10 m
- body material: aluminum
- mechanical impact protection: IK06
- packaging: 1 pc, box



ZS2930 1/-/-10
15 31 252 930 ZS2930

- power: 51 W
- luminous flux: 4 600 lm
- color temperature: 4 000 K
- light color: neutral white
- color rendering index (CRI): Ra > 80
- voltage: 220-240 V~
- IP rating: IP44
- beam angle: 120°
- dimensions: 208 × 223 × 75 mm

- detection range of PIR Sensor: 10 m
- body material: aluminum
- mechanical impact protection: IK06
- packaging: 1 pc, box



ZS2940 1/-/-5
15 31 252 940 ZS2940

TAMBO

CLASSIC

- aluminium with a milky PC diffuser for a pleasantly light
- cost savings of up to 90% compared to halogen spotlights
- IP65 protection guarantees water resistance
- ultra-thin design
- bevelled bracket allows easy installation on the wall
- 3 years warranty
- use: commercial, private buildings and ambient environment

- power: 10,5 W
- luminous flux: 800 lm
- color temperature: 4 000 K
- light color: neutral white
- color rendering index (CRI): Ra > 80
- voltage: 220–240 V~
- IP rating: IP65
- beam angle: 120°
- dimensions: 105 × 102 × 55 mm



- supply cable length: 30 cm
- lead-in cable material: rubber
- body material: aluminum
- mechanical impact protection: IK08
- packaging: 1 pc, box

**ZS2511**

1/-/-14

15 31 242 511

ZS2511

- power: 20 W
- luminous flux: 1 600 lm
- color temperature: 4 000 K
- light color: neutral white
- color rendering index (CRI): Ra > 80
- voltage: 220–240 V~
- IP rating: IP65
- beam angle: 120°
- dimensions: 135 × 101 × 55 mm



- supply cable length: 30 cm
- lead-in cable material: rubber
- body material: aluminum
- mechanical impact protection: IK08
- packaging: 1 pc, box

**ZS2521**

1/-/-12

15 31 242 521

ZS2521

- power: 30.5 W
- luminous flux: 2 600 lm
- color temperature: 4 000 K
- light color: neutral white
- color rendering index (CRI): Ra > 80
- voltage: 220–240 V~
- IP rating: IP65
- beam angle: 120°
- dimensions: 165 × 114 × 55 mm



- supply cable length: 30 cm
- lead-in cable material: rubber
- body material: aluminum
- mechanical impact protection: IK08
- packaging: 1 pc, box

**ZS2531**

1/-/-10

15 31 242 531

ZS2531

- power: 51 W
- luminous flux: 4 300 lm
- color temperature: 4 000 K
- light color: neutral white
- color rendering index (CRI): Ra > 80
- voltage: 220–240 V~
- IP rating: IP65
- beam angle: 120°
- dimensions: 210 × 142 × 55 mm



- supply cable length: 30 cm
- lead-in cable material: rubber
- body material: aluminum
- mechanical impact protection: IK08
- packaging: 1 pc, box

**ZS2541**

1/-/-7

15 31 242 541

ZS2541

- power: 10,5 W
- luminous flux: 800 lm
- color temperature: 4 000 K
- light color: neutral white
- color rendering index (CRI): Ra > 80
- voltage: 220-240 V~
- IP rating: IP54
- beam angle: 120°
- dimensions: 105 × 143 × 64 mm



- supply cable length: 30 cm
- detection range of PIR Sensor: 10 m
- lead-in cable material: rubber
- body material: aluminum
- mechanical impact protection: IK06
- packaging: 1 pc, box



ZS2911 1/-/-/14
15 31 242 911 ZS2911

- power: 20 W
- luminous flux: 1 600 lm
- color temperature: 4 000 K
- light color: neutral white
- color rendering index (CRI): Ra > 80
- voltage: 220-240 V~
- IP rating: IP54
- beam angle: 120°
- dimensions: 135 × 165 × 64 mm



- supply cable length: 30 cm
- detection range of PIR Sensor: 10 m
- lead-in cable material: rubber
- body material: aluminum
- mechanical impact protection: IK06
- packaging: 1 pc, box



ZS2921 1/-/-/12
15 31 242 921 ZS2921

- power: 30.5 W
- luminous flux: 2 600 lm
- color temperature: 4 000 K
- light color: neutral white
- color rendering index (CRI): Ra > 80
- voltage: 220-240 V~
- IP rating: IP54
- beam angle: 120°
- dimensions: 165 × 185 × 64 mm



- supply cable length: 30 cm
- detection range of PIR Sensor: 10 m
- lead-in cable material: rubber
- body material: aluminum
- mechanical impact protection: IK06
- packaging: 1 pc, box



ZS2931 1/-/-/10
15 31 242 931 ZS2931

- power: 51 W
- luminous flux: 4 300 lm
- color temperature: 4 000 K
- light color: neutral white
- color rendering index (CRI): Ra > 80
- voltage: 220-240 V~
- IP rating: IP54
- beam angle: 120°
- dimensions: 210 × 217 × 64 mm



- supply cable length: 30 cm
- detection range of PIR Sensor: 10 m
- lead-in cable material: rubber
- body material: aluminum
- mechanical impact protection: IK06
- packaging: 1 pc, box



ZS2941 1/-/-/7
15 31 242 941 ZS2941

Luminaires

Floodlights

ESSENTIAL

SIMPO

ESSENTIAL

- motion sensor allows to set the daylight sensor and duration
- cost savings of up to 90% compared to halogen spotlights
- IP44 protection ensures water resistance
- ultra-thin design
- bevelled bracket allows easy installation on the wall
- 3 years warranty
- use: private objects and surrounding environment

- power: 10 W
- luminous flux: 1 000 lm
- color temperature: 4 000 K
- light color: neutral white
- color rendering index (CRI): Ra > 80
- voltage: 220–240 V~
- IP rating: IP65
- beam angle: 120°
- dimensions: 85 × 73 × 25 mm



- supply cable length: 20 cm
- lead-in cable material: rubber
- lead-in cable type: H05RN-F
- body material: aluminum
- packaging: 1 pc, box

 4 000 K
 NEUTRAL
 WHITE

ZS2213

1/-/-48

15 31 221 300

ZS2213

- power: 20 W
- luminous flux: 2 000 lm
- color temperature: 4 000 K
- light color: neutral white
- color rendering index (CRI): Ra > 80
- voltage: 220–240 V~
- IP rating: IP65
- beam angle: 120°
- dimensions: 114 × 92 × 25 mm



- supply cable length: 20 cm
- lead-in cable material: rubber
- lead-in cable type: H05RN-F
- body material: aluminum
- packaging: 1 pc, box

 4 000 K
 NEUTRAL
 WHITE

ZS2223

1/-/-24

15 31 222 300

ZS2223

- power: 30 W
- luminous flux: 3 000 lm
- color temperature: 4 000 K
- light color: neutral white
- color rendering index (CRI): Ra > 80
- voltage: 220–240 V~
- IP rating: IP65
- beam angle: 120°
- dimensions: 143 × 113 × 25 mm



- supply cable length: 20 cm
- lead-in cable material: rubber
- lead-in cable type: H05RN-F
- body material: aluminum
- packaging: 1 pc, box

 4 000 K
 NEUTRAL
 WHITE

ZS2233

1/-/-24

15 31 223 300

ZS2233

- power: 50 W
- luminous flux: 5 000 lm
- color temperature: 4 000 K
- light color: neutral white
- color rendering index (CRI): Ra > 80
- voltage: 220-240 V~
- IP rating: IP65
- beam angle: 120°
- dimensions: 182 × 142 × 27 mm



- supply cable length: 20 cm
- lead-in cable material: rubber
- lead-in cable type: H05RN-F
- body material: aluminum
- packaging: 1 pc, box

4 000 K
NEUTRAL
WHITE



ZS2243
15 31 224 300

1/-/-12
ZS2243

- power: 10 W
- luminous flux: 1 000 lm
- color temperature: 4 000 K
- light color: neutral white
- color rendering index (CRI): Ra > 80
- voltage: 220-240 V~
- IP rating: IP44
- beam angle: 120°
- dimensions: 85 × 141 × 52 mm



- supply cable length: 20 cm
- detection range of PIR Sensor: 8 m
- lead-in cable material: rubber
- lead-in cable type: H05RN-F
- body material: aluminum
- packaging: 1 pc, box

4 000 K
NEUTRAL
WHITE



ZS2313
15 31 231 300

1/-/-16
ZS2313

- power: 20 W
- luminous flux: 2 000 lm
- color temperature: 4 000 K
- light color: neutral white
- color rendering index (CRI): Ra > 80
- voltage: 220-240 V~
- IP rating: IP44
- beam angle: 120°
- dimensions: 114 × 156 × 52 mm



- supply cable length: 20 cm
- detection range of PIR Sensor: 8 m
- lead-in cable material: rubber
- lead-in cable type: H05RN-F
- body material: aluminum
- packaging: 1 pc, box

4 000 K
NEUTRAL
WHITE



ZS2323
15 31 232 300

1/-/-20
ZS2323

- power: 30 W
- luminous flux: 3 000 lm
- color temperature: 4 000 K
- light color: neutral white
- color rendering index (CRI): Ra > 80
- voltage: 220-240 V~
- IP rating: IP44
- beam angle: 120°
- dimensions: 143 × 175 × 52 mm



- supply cable length: 20 cm
- detection range of PIR Sensor: 8 m
- lead-in cable material: rubber
- lead-in cable type: H05RN-F
- body material: aluminum
- packaging: 1 pc, box

4 000 K
NEUTRAL
WHITE



ZS2333
15 31 233 300

1/-/-10
ZS2333

- power: 50 W
- luminous flux: 5 000 lm
- color temperature: 4 000 K
- light color: neutral white
- color rendering index (CRI): Ra > 80
- voltage: 220-240 V~
- IP rating: IP44
- beam angle: 120°
- dimensions: 182 × 199 × 52 mm



- supply cable length: 20 cm
- detection range of PIR Sensor: 8 m
- lead-in cable material: rubber
- lead-in cable type: H05RN-F
- body material: aluminum
- packaging: 1 pc, box

4 000 K
NEUTRAL
WHITE



ZS2343
15 31 234 300

1/-/-10
ZS2343

Luminaires

Floodlights

Accessories

- water resistant connector for connection of 2 three-wire cables
- steel folding tripod as a stand for 2 floodlights
- high enclosure rating of IP68, silicone sealing
- height: 66–180 cm, load capacity max. 4 kg

- voltage: 250 V
- IP rating: IP68
- dimensions: 26 × 70 mm in diameter
- body material: plastic (PA66)
- mechanical impact protection: IK08
- packaging: 1 pc, packet

**ZS9010**

1/-/10/90

15 31 900 010

ZS9010

- voltage: 250 V
- IP rating: IP68
- dimensions: 26 × 90 mm in diameter
- body material: plastic (PA66)
- mechanical impact protection: IK08
- packaging: 1 pc, packet

**ZS9020**

1/-/10/90

15 31 900 020

ZS9020

- voltage: 250 V
- IP rating: IP68
- dimensions: 26 × 90 × 62 mm
- body material: plastic (PA66)
- mechanical impact protection: IK08
- packaging: 1 pc, packet

**ZS9030**

1/-/10/80

15 31 900 030

ZS9030

- dimensions: 140 × 120 × 630 mm
- body material: steel
- packaging: 1 pc, box

4 kg
max.**ZS9510**

1/-/-/4

15 31 950 010

ZS9510

Luminaires

Work Lights

PROFI

CANNO

PROFI

- mains powered and suitable for indoor and outdoor use
- robust construction which is shockproof and waterproof
- wide area illumination angle of 360°
- water and impact resistance due to IP54 and IK07 protection
- designed handle and folding design makes easy to transport
- 3 years warranty
- use: construction, house, garage, workshop, car repair shop

- power: 70 W
- luminous flux: 7 000 lm
- color temperature: 4 000 K
- light color: neutral white
- color rendering index (CRI): Ra > 80
- voltage: 220–240 V~
- IP rating: IP54
- beam angle: 360°
- dimensions: 205 × 160 × 880 mm

- supply cable length: 2 m
- number of adapter plugs: 1
- adapter plug type: SCHUKO
- lead-in cable material: rubber
- lead-in cable type: H07RN-F
- body material: plastic (ABS)
- mechanical impact protection: IK07
- packaging: 1 pc, box



70 W

7 000 lm

IP54

IK07

4 000 K
NEUTRAL
WHITE3
YEARS
WARRANTY**ZS3360S**

1/-/-/1

15 42 033 601

ZS3360S

Luminaires

Work Lights

CLASSIC

ILIO

CLASSIC

- mains powered, suitable for indoor and outdoor use
- robust shockproof and waterproof construction
- wide area illumination angle of 110°
- shockproof and waterproof thanks to IP44 and IK10 protection
- handle and folding design allowing easy reflector transport
- a 3-year warranty
- usage: constructions, houses, garages, workshops, etc.

- power: 21 W
- luminous flux: 1 900 lm
- color temperature: 4 000 K
- light color: neutral white
- color rendering index (CRI): Ra > 80
- voltage: 220–240 V~
- IP rating: IP44
- beam angle: 110°
- dimensions: 215 × 185 × 250 mm

- supply cable length: 1.5 m
- lead-in cable material: rubber
- lead-in cable type: H07RN-F
- body material: aluminum
- mechanical impact protection: IK10
- packaging: 1 pc, box



ZS3322 1/-/-/6
15 42 033 220 ZS3322

- power: 31 W
- luminous flux: 2 800 lm
- color temperature: 4 000 K
- light color: neutral white
- color rendering index (CRI): Ra > 80
- voltage: 220–240 V~
- IP rating: IP44
- beam angle: 110°
- dimensions: 240 × 185 × 275 mm

- supply cable length: 1.5 m
- lead-in cable material: rubber
- lead-in cable type: H07RN-F
- body material: aluminum
- mechanical impact protection: IK10
- packaging: 1 pc, box



ZS3332 1/-/-/4
15 42 033 320 ZS3332

- power: 51 W
- luminous flux: 4 600 lm
- color temperature: 4 000 K
- light color: neutral white
- color rendering index (CRI): Ra > 80
- voltage: 220–240 V~
- IP rating: IP44
- beam angle: 110°
- dimensions: 270 × 185 × 275 mm

- supply cable length: 1.5 m
- lead-in cable material: rubber
- lead-in cable type: H07RN-F
- body material: aluminum
- mechanical impact protection: IK10
- packaging: 1 pc, box



ZS3342 1/-/-/4
15 42 033 420 ZS3342

HOBBY SLIM

CLASSIC

- higher coverage for indoor and outdoor lighting
- steel folding tripod
- resistant to low outdoor temperatures or water droplets
- adjustable direction of light wherever needed
- adjustable up to 66–185 cm height
- IP65 protection guarantees water resistance
- usage: constructions, houses, garages, workshops, etc.

- power: 2× 20,5 W
- luminous flux: 2× 1 600 lm
- color temperature: 4 000 K
- light color: neutral white
- color rendering index (CRI): Ra > 80
- voltage: 220–240 V~
- IP rating: IP65
- beam angle: 120°
- dimensions: 860 × 860 × 1 850 mm

- supply cable length: 3 m
- lead-in cable material: rubber
- lead-in cable type: H07RN-F
- body material: aluminum
- mechanical impact protection: IK08
- packaging: 1 pc, box



ZS2221.2

1/-/-/2

15 31 222 120

ZS2221.2

- power: 2× 30 W
- luminous flux: 2× 2 400 lm
- color temperature: 4 000 K
- light color: neutral white
- color rendering index (CRI): Ra > 80
- voltage: 220–240 V~
- IP rating: IP65
- beam angle: 120°
- dimensions: 860 × 860 × 1 850 mm

- supply cable length: 3 m
- lead-in cable material: rubber
- lead-in cable type: H07RN-F
- body material: aluminum
- mechanical impact protection: IK08
- packaging: 1 pc, box



ZS2231.2

1/-/-/2

15 31 223 120

ZS2231.2

ACCO

CLASSIC

- floodlights with accumulators offer maximum variability
- robust design suitable for working in hostile environments
- no need for a present power source
- folding stand for easy transport and storage
- IP54 coverage ensures water resistance
- 120° lighting angle
- a 3-year warranty
- usage: constructions, garages, workshops, camping, etc.

- power: 10 W
- luminous flux: 1 000 lm
- color temperature: 6 500 K
- light color: cool white
- color rendering index (CRI): Ra > 80
- voltage: 5 V DC 220–240 V AC
- IP rating: IP54
- beam angle: 120°
- dimensions: 212 × 177 × 224 mm

- battery: Li-Ion 4 400 mAh
- AKU lighting time: 3 – 10 hours
- body material: aluminum
- packaging: 1 pc, box



ZS2812

1/-/-/5

15 31 281 200

ZS2812

- power: 20 W
- luminous flux: 2 000 lm
- color temperature: 6 500 K
- light color: cool white
- color rendering index (CRI): Ra > 80
- voltage: 5 V DC 220-240 V AC
- IP rating: IP54
- beam angle: 120°
- dimensions: 266 × 220 × 273 mm

- battery: Li-Ion 6 600 mAh
- AKU lighting time: 3 – 10 hours
- body material: aluminum
- packaging: 1 pc, box



ZS2822 1/-/-/4
15 31 282 200 ZS2822

- power: 30 W
- luminous flux: 3 000 lm
- color temperature: 6 500 K
- light color: cool white
- color rendering index (CRI): Ra > 80
- voltage: 5 V DC 220-240 V AC
- IP rating: IP54
- beam angle: 120°
- dimensions: 292 × 219 × 273 mm

- battery: Li-Ion 10 000 mAh
- AKU lighting time: 3 – 10 hours
- body material: aluminum
- packaging: 1 pc, box



ZS2832 1/-/-/2
15 31 283 200 ZS2832

Luminaires

Linear Luminaires

PROFI PLUS

ORTO

PROFI PLUS

- modern luminaires are made of high-quality aluminium profile
- they can be combined into different shapes
- ready for continuous installation in linear wiring
- possibility of mounted, built-in or hanging installation
- 5 years warranty
- use: office lighting, sales areas, interior spaces

- power: 8 W
- luminous flux: 800 lm
- color temperature: 4 000 K
- body material: aluminum
- color rendering index (CRI): Ra > 80
- beam angle: 110°
- type of mounting: surface/recessed
- dimensions: 151 × 151 × 58 mm
- body colour: white

- line: ORTO
- warranty period: 5 years
- UGR<: 22



ZALL 1/-/-/12
15 43 081 000 ZALL

- power: 12 W
- luminous flux: 1 200 lm
- color temperature: 4 000 K
- body material: aluminum
- color rendering index (CRI): Ra > 80
- beam angle: 110°
- type of mounting: surface/recessed
- dimensions: 252 × 151 × 58 mm
- body colour: white

- line: ORTO
- warranty period: 5 years
- UGR<: 22



ZALT
15 43 121 000

1/-/-8
ZALT

- power: 15 W
- luminous flux: 1 500 lm
- color temperature: 4 000 K
- body material: aluminum
- color rendering index (CRI): Ra > 80
- beam angle: 110°
- type of mounting: surface/recessed
- dimensions: 252 × 252 × 58 mm
- body colour: white

- line: ORTO
- warranty period: 5 years
- UGR<: 22



ZALX
15 43 151 000

1/-/-6
ZALX

- power: 19 W
- luminous flux: 2 000 lm
- color temperature: 4 000 K
- body material: aluminum
- color rendering index (CRI): Ra > 80
- beam angle: 110°
- type of mounting: surface/recessed
- dimensions: 600 × 49 × 58 mm
- body colour: white

- line: ORTO
- warranty period: 5 years
- UGR<: 22



ZAL192
15 43 191 000

1/-/-6
ZAL192

- power: 38 W
- luminous flux: 4 200 lm
- color temperature: 4 000 K
- body material: aluminum
- color rendering index (CRI): Ra > 80
- beam angle: 110°
- type of mounting: surface/recessed
- dimensions: 1 200 × 49 × 58 mm
- body colour: white

- line: ORTO
- warranty period: 5 years
- UGR<: 22



ZAL382
15 43 381 000

1/-/-6
ZAL382

- product: set of ropes
- dimensions: 150 cm (cable length)
- designed for: linear luminaires
- packaging: 1 ks, box



ZALAP
15 43 999 000

1/-/-100
ZALAP

- product: set of hooks
- designed for: linear luminaires
- packaging: 1 ks, box

**ZALAR**

1/-/-/36

15 43 999 001

ZALAR

- product: power supply box
- material: metal
- designed for: linear luminaires

**ZALAS**

1/-/-/24

15 43 999 002

ZALAS

Luminaires

LED Panels

PROFI PLUS

PROXO

PROFI PLUS

- the square or rectangular series are an effective option
- high colour rendering index models
- high efficiency and energy saving
- resistance to yellowing due to UV radiation
- 5 years warranty
- use: offices, classrooms and indoor areas

- power: 40 W
- replacement of incandescent bulb: 4× 18 W CFL
- luminous flux: 3 700 lm
- color temperature: 4 000 K
- body material: aluminum
- color rendering index (CRI): Ra > 95
- beam angle: 90°
- type of mounting: recessed
- dimensions: 595 × 595 × 10 mm

- body colour: white
- line: PROXO
- warranty period: 5 years
- UGR<: 19

**ZR1433**

1/-/-/5

15 44 104 032

ZR1433



- power: 19 W
- replacement of incandescent bulb: 2x 18 W CFL
- luminous flux: 1 800 lm
- color temperature: 4 000 K
- body material: aluminum
- color rendering index (CRI): Ra > 80
- beam angle: 120°
- type of mounting: recessed
- dimensions: 595 x 295 x 10,4 mm

- body colour: white
- line: PROXO
- warranty period: 5 years
- UGR<: 22



ZR2212 1/-/-/8
15 41 181 200 ZR2212

- power: 33 W
- replacement of incandescent bulb: 4x 18 W CFL
- luminous flux: 4 360 lm
- color temperature: 4 000 K
- body material: aluminum
- color rendering index (CRI): Ra > 80
- beam angle: 120°
- type of mounting: recessed
- dimensions: 595 x 595 x 10 mm

- body colour: white
- line: PROXO
- warranty period: 5 years
- UGR<: 22



ZB1114 1/-/-/4
15 44 103 320 ZB1114

- power: 33 W
- replacement of incandescent bulb: 4x 18 W CFL
- luminous flux: 4 100 lm
- color temperature: 4 000 K
- body material: aluminum
- color rendering index (CRI): Ra > 80
- beam angle: 90°
- type of mounting: recessed
- dimensions: 595 x 595 x 10 mm

- body colour: white
- line: PROXO
- warranty period: 5 years
- UGR<: 19



ZB1124 1/-/-/4
15 44 103 321 ZB1124

- power: 33 W
- replacement of incandescent bulb: 2x 36 W CFL
- luminous flux: 4 360 lm
- color temperature: 4 000 K
- body material: aluminum
- color rendering index (CRI): Ra > 80
- beam angle: 120°
- type of mounting: recessed
- dimensions: 295 x 1 195 x 10 mm

- body colour: white
- line: PROXO
- warranty period: 5 years
- UGR<: 22



ZB3114 1/-/-/4
15 44 203 320 ZB3114

- power: 33 W
- replacement of incandescent bulb: 2x 36 W CFL
- luminous flux: 4 100 lm
- color temperature: 4 000 K
- body material: aluminum
- color rendering index (CRI): Ra > 80
- beam angle: 90°
- type of mounting: recessed
- dimensions: 295 x 1 195 x 10 mm

- body colour: white
- line: PROXO
- warranty period: 5 years
- UGR<: 19



ZB3124 1/-/-/4
15 44 203 321 ZB3124

PIXXO

PROFI PLUS

- square-shaped luminaire is for indoor lighting
- IP65 protection guarantees water resistance
- resistance of the light-conducting plate against yellowing due to U
- 5 years warranty
- use: offices, classrooms and indoor areas

- power: 48 W
- replacement of incandescent bulb: 4× 18 W CFL
- luminous flux: 4 800 lm
- color temperature: 4 000 K
- body material: aluminum
- color rendering index (CRI): Ra > 80
- beam angle: 120°
- type of mounting: recessed
- dimensions: 595 × 595 × 10 mm
- body colour: white
- line: PROXO
- warranty period: 5 years
- UGR<: 22



ZR1532 1/-/-/4
15 44 104 820 ZR1532

LEXXO

PROFI PLUS

- modern energy-saving luminaires use backlit technology
- more uniform light emission and higher luminous efficiency
- outstanding performance and lighting quality – CRI > 80
- pleasant diffused light with a beam angle of 90°/120°
- 5 years warranty
- use: offices, classrooms and indoor areas

- power: 34 W
- replacement of incandescent bulb: 4× 18 W CFL
- luminous flux: 4 200 lm
- color temperature: 4 000 K
- body material: steel plate
- color rendering index (CRI): Ra > 80
- beam angle: 120°
- type of mounting: recessed
- dimensions: 595 × 595 × 30 mm
- body colour: white
- line: LEXXO
- warranty period: 5 years
- UGR<: 22



ZR1642 1/-/-/4
15 44 103 428 ZR1642

- product: frame for surface installation
- dimensions: 600 × 600 × 70 mm
- material: aluminum
- designed for: Backlit panel 60 × 60
- color: white
- packaging: 1 ks, box



ZR9036 1/-/-/20
15 44 100 000 ZR9036

- power: 30 W
 - replacement of incandescent bulb: 4× 18 W CFL
 - luminous flux: 4 000 lm
 - color temperature: 4 000 K
 - body material: steel plate
 - color rendering index (CRI): Ra > 80
 - beam angle: 120°
 - type of mounting: recessed
 - dimensions: 595 × 595 × 25 mm
- body colour: white
 - line: LEXXO
 - warranty period: 5 years
 - UGR<: 19



ZB2124 1/-/-/4
15 44 103 026 ZB2124

- power: 30 W
 - replacement of incandescent bulb: 4× 18 W CFL
 - luminous flux: 4 200 lm
 - color temperature: 4 000 K
 - body material: steel plate
 - color rendering index (CRI): Ra > 80
 - beam angle: 120°
 - type of mounting: recessed
 - dimensions: 595 × 595 × 25 mm
- body colour: white
 - line: LEXXO
 - warranty period: 5 years
 - UGR<: 22



ZB2154 1/-/-/4
15 44 103 027 ZB2154

TROXO

PROFI PLUS

- TROXO LED panels combine an attractive square design
- high luminous efficiency and energy savings
- pleasant diffused light with a very low glare index
- illuminates the room with enough intensity at an angle of 85°
- does not dazzle the surroundings with an wide beam angle
- 5 years warranty
- use: corridors, offices, classrooms, department stores

- power: 27 W
 - replacement of incandescent bulb: 4× 18 W CFL
 - luminous flux: 3 150 lm
 - color temperature: 4 000 K
 - body material: steel plate
 - color rendering index (CRI): Ra > 80
 - beam angle: 85°
 - type of mounting: recessed
 - dimensions: 595 × 595 × 23.2 mm
- body colour: white
 - line: TROXO
 - warranty period: 5 years
 - UGR<: 16



ZR1722 1/-/-/4
15 44 212 730 ZR1722

VEXXO

PROFI PLUS

- the square or rectangular series are an effective option
- high efficiency and energy saving
- resistance to yellowing due to UV radiation
- integrated surface mounting frame
- 5 years warranty
- use: offices, classrooms and indoor areas

- power: 33 W
- replacement of incandescent bulb: 4× 18 W CFL
- luminous flux: 4 000 lm
- color temperature: 4 000 K
- body material: aluminum
- color rendering index (CRI): Ra > 80
- beam angle: 90°
- type of mounting: surface
- dimensions: 601 × 601 × 37 mm
- body colour: white
- line: VEXXO
- warranty period: 5 years
- UGR<: 19



ZB1524 1/-/-/4
15 44 103 322 ZB1524

- power: 33 W
- replacement of incandescent bulb: 2× 36 W CFL
- luminous flux: 4 000 lm
- color temperature: 4 000 K
- body material: aluminum
- color rendering index (CRI): Ra > 80
- beam angle: 90°
- type of mounting: surface
- dimensions: 1 201 × 301 × 37 mm
- body colour: white
- line: VEXXO
- warranty period: 5 years
- UGR<: 19



ZB3524 1/-/-/4
15 44 203 322 ZB3524

Luminaires

LED Panels

EXCLUSIVE

RIVI

EXCLUSIVE

- can be dimmed progressively by remote control
- ability to create and easily control groups of panels
- four preset light scenes
- 3 years warranty
- use: interiors in homes, offices or hotels

- power: 36 W
- replacement of incandescent bulb: 4× 18 W CFL
- luminous flux: 3 600 lm
- color temperature: 2 700–6 000 K
- body material: aluminum
- color rendering index (CRI): Ra > 80
- beam angle: 90°
- type of mounting: recessed
- dimensions: 595 × 595 × 10 mm
- dimming function
- body colour: white
- line: RIVI
- warranty period: 3 years
- UGR<: 19

**ZR5410**

1/-/-/4

15 44 213 670

ZR5410

- product: remote controller for ZR5410
- designed for: Exclusive LED panels

**ZR9041**

1/-/-/100

15 44 300 001

ZR9041

Luminaires

LED Panels

PROFI

MAXXO

PROFI

- the square and rectangular for lighting office spaces
- high efficiency and energy saving
- pleasantly diffused light
- option to purchase a remote control for the ZR5410
- 3 years warranty
- use: offices, classrooms and indoor areas

- power: 36 W
- replacement of incandescent bulb: 4× 18 W CFL
- luminous flux: 4 100 lm
- color temperature: 3 000 K
- body material: aluminum
- color rendering index (CRI): Ra > 80
- beam angle: 90°
- type of mounting: recessed
- dimensions: 595 × 595 × 10 mm

- body colour: white
- line: MAXXO
- warranty period: 5 years
- UGR<: 19

**ZB1223**

1/-/-/5

15 44 103 610

ZB1223

- power: 36 W
- replacement of incandescent bulb: 4× 18 W CFL
- luminous flux: 4 320 lm
- color temperature: 4 000 K
- body material: aluminum
- color rendering index (CRI): Ra > 80
- beam angle: 120°
- type of mounting: recessed
- dimensions: 595 × 595 × 10 mm

- body colour: white
- line: MAXXO
- warranty period: 5 years
- UGR<: 22

**ZB1214**

1/-/-/5

15 44 103 628

ZB1214

- power: 36 W
- replacement of incandescent bulb: 4× 18 W CFL
- luminous flux: 4 320 lm
- color temperature: 4 000 K
- body material: aluminum
- color rendering index (CRI): Ra > 80
- beam angle: 90°
- type of mounting: recessed
- dimensions: 595 × 595 × 10 mm

- body colour: white
- line: MAXXO
- warranty period: 5 years
- UGR<: 19

**ZB1224**

1/-/-/5

15 44 103 629

ZB1224

- power: 36 W
- replacement of incandescent bulb: 2× 36 W CFL
- luminous flux: 4 320 lm
- color temperature: 4 000 K
- body material: aluminum
- color rendering index (CRI): Ra > 80
- beam angle: 120°
- type of mounting: recessed
- dimensions: 1 195 × 295 × 10 mm
- body colour: white
- line: MAXXO
- warranty period: 5 years
- UGR<: 22



ZB3214 1/-/-/5
15 44 103 630 ZB3214

- power: 36 W
- replacement of incandescent bulb: 2× 36 W CFL
- luminous flux: 4 320 lm
- color temperature: 4 000 K
- body material: aluminum
- color rendering index (CRI): Ra > 80
- beam angle: 90°
- type of mounting: recessed
- dimensions: 1 195 × 295 × 10 mm
- body colour: white
- line: MAXXO
- warranty period: 5 years
- UGR<: 19



ZB3224 1/-/-/5
15 44 103 631 ZB3224

REXXO

PROFI

- modern energy-saving luminaires use backlit technology
- more uniform light emission and higher luminous efficiency
- outstanding performance and lighting quality – CRI ≥ 80
- pleasantly diffused light
- 3 years warranty
- use: offices, classrooms and indoor areas

- power: 36 W
- replacement of incandescent bulb: 4× 18 W CFL
- luminous flux: 4 000 lm
- color temperature: 4 000 K
- body material: steel plate
- color rendering index (CRI): Ra > 80
- beam angle: 120°
- type of mounting: recessed
- dimensions: 595 × 595 × 24 mm
- body colour: white
- line: REXXO
- warranty period: 5 years
- UGR<: 22



ZB2214 1/-/-/6
15 44 103 622 ZB2214

- power: 36 W
- replacement of incandescent bulb: 4× 18 W CFL
- luminous flux: 4 000 lm
- color temperature: 4 000 K
- body material: steel plate
- color rendering index (CRI): Ra > 80
- beam angle: 120°
- type of mounting: recessed
- dimensions: 595 × 595 × 24 mm
- body colour: white
- line: REXXO
- warranty period: 5 years
- UGR<: 19



ZB2224 1/-/-/6
15 44 103 623 ZB2224

Luminaires

LED Panels

ESSENTIAL

DAXXO

ESSENTIAL

- more uniform light emission and higher luminous efficiency
- outstanding performance and lighting quality – CRI ≥ 80
- pleasantly diffused light
- use: offices, classrooms and indoor areas

- power: 36 W
- replacement of incandescent bulb: 4× 18 W CFL
- luminous flux: 3 600 lm
- color temperature: 4 000 K
- body material: steel plate
- color rendering index (CRI): Ra > 80
- beam angle: 120°
- type of mounting: recessed
- dimensions: 595 × 595 × 30 mm

- body colour: white
- warranty period: 2 years
- UGR<: 22



4 000 K
NEUTRAL
WHITE



8 592920 119914

ZB2414

1/-/-/6

15 44 103 621

ZB2414

Luminaires

LED Panels

Accessories

ZR9001

1/-/-/100

15 42 009 001

ZR9001



8 592920 034415



product: spring set = material: metal = designed for: LED panel 60 × 60 (30) (PROXO, MAXXO) = packaging: 4 ks, packet

ZR9002

1/-/-/100

15 42 009 002

ZR9002



8 592920 034439



product: spring set = material: metal = designed for: LED panel 30 × 120 (PROXO, MAXXO) = packaging: 6 ks, packet

ZR9010

1/-/-/100

15 42 009 010

ZR9010



8 592920 034453



product: set of hooks = material: metal = designed for: LED panel 60 × 60 (30) (PROXO, MAXXO) = packaging: 4 ks, packet

ZR9011

1/-/-/100

15 42 009 011

ZR9011



8 592920 034477

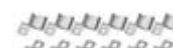

product: set of hooks = material: metal = designed for: LED panel 30 × 120 (PROXO, MAXXO) = packaging: 6 ks, packet

ZR9020

1/-/-/100

15 42 009 020

ZR9020



8 592920 034491



product: set of ropes = dimensions: 5 – 145 cm (cable length) = material: metal = designed for: LED panel 60 × 60 (30) (PROXO, MAXXO) = packaging: 4 ks, packet

ZR9021

1/-/-/100

15 42 009 021

ZR9021





8 592920 034514



product: set of ropes = dimensions: 5 – 145 cm (cable length) = material: metal = designed for: LED panel 30 × 120 (PROXO, MAXXO) = packaging: 6 ks, packet





ZR9034 1/-/-/20
15 42 009 034 ZR9034



product: frame for surface installation = dimensions: 600 × 600 × 45 mm = material: aluminum = designed for: LED panel 60 × 60 (PROXO, MAXXO) = color: white = packaging: 1 ks, box

ZR9035 1/-/-/15
15 42 009 035 ZR9035



product: frame for surface installation = dimensions: 1 200 × 300 × 45 mm = material: aluminum = designed for: LED panel 30 × 120 (PROXO, MAXXO) = color: white = packaging: 1 ks, box

ZR9036 1/-/-/20
15 44 100 000 ZR9036

product: frame for surface installation = dimensions: 600 × 600 × 70 mm = material: aluminum = designed for: Backlit panel 60 × 60 = color: white = packaging: 1 ks, box

ZR9041 1/-/-/100
15 44 300 001 ZR9041



product: remote controller for ZR5410 = designed for: Exclusive LED panels

Luminaires

Drivers

- spare external drivers enabling dimming and controlling LED lights
- ensure optimal functioning, durability, energy efficiency and protection against damage to the LEDs
- 5 year warranty



ZZ1435T 1/-/-/50
15 60 014 350 ZZ1435T

= voltage input: 220–240 V AC
 = frequency: 50/60 Hz
 = output voltage: 25–40 V DC
 = output current: 200–350 mA
 = power: 14 W
 = dimensions: 97 × 46 × 31 mm

= type: TRIAK
 = warranty period: 5 years

ZZ2055T 1/-/-/50
15 60 020 550 ZZ2055T

= voltage input: 220–240 V AC
 = frequency: 50/60 Hz
 = output voltage: 25–40 V DC
 = output current: 400–550 mA
 = power: 20 W
 = dimensions: 117 × 46 × 31 mm

= type: TRIAK
 = warranty period: 5 years

**ZZ3070T**

1/-/-/50

15 60 030 700

ZZ3070T



8 592920 114346

28 W

5

YEARS WARRANTY

- voltage input: 220–240 V AC
- frequency: 50/60 Hz
- output voltage: 25–40 V DC
- output current: 550–700 mA
- power: 28 W
- dimensions: 117 × 46 × 31 mm

- type: TRIAK
- warranty period: 5 years

ZZ409BD

1/-/-/48

15 60 040 900

ZZ409BD



8 592920 107102

40 W

5

YEARS WARRANTY

- voltage input: 200–240 V AC
- frequency: 50/60 Hz
- output voltage: 6–42 V DC
- output current: 450–1 100 mA
- power: 40 W
- dimensions: 103 × 68 × 30 mm

- type: DALI 2.0, PUSH DIM
- warranty period: 5 years

Luminaires

Surface Luminaires

EXCLUSIVE

RIVI

EXCLUSIVE

- made of cast aluminium and acrylic glass
- suitable for surface mounting
- high-quality drivers LIFUD
- LGP - PMMA - pleasantly diffused light
- easy installation thanks to the installation console
- 3 years warranty
- use: interiors in homes, offices or hotels.

- power: 40 W
- luminous flux: 380–3 800 lm
- color temperature: 2 700–6 000 K
- body material: aluminum
- color rendering index (CRI): Ra > 80
- beam angle: 115°
- type of mounting: surface
- dimensions: 595 × 595 × 52 mm
- dimming function

- body colour: white
- line: RIVI
- warranty period: 3 years
- UGR<: 22



8 592920 090480

ZM5173

1/-/-/4

15 44 103 603

ZM5173

- power: 25 W
- luminous flux: 210–2 100 lm
- color temperature: 2 700–6 000 K
- body material: aluminum
- color rendering index (CRI): Ra > 80
- beam angle: 115°
- type of mounting: surface
- dimensions: 295 × 595 × 52 mm
- dimming function

- body colour: white
- line: RIVI
- warranty period: 3 years
- UGR<: 22



8 592920 090466

ZM5172

1/-/-/4

15 44 102 400

ZM5172

- power: 20 W
- luminous flux: 140-1 400 lm
- color temperature: 2 700-6 000 K
- body material: aluminum
- color rendering index (CRI): Ra > 80
- beam angle: 115°
- type of mounting: surface
- dimensions: 295 × 295 × 52 mm
- dimming function
- body colour: white
- line: RIVI
- warranty period: 3 years
- UGR<: 22



ZM5171 1/-/-/3
15 44 101 800 ZM5171

ALVI

EXCLUSIVE

- rectangle and circular shape
- included frames in 2 colours for circular models
- very economical and durable LED diodes
- fluent dimmig via remote control
- durable metal body and difussers made of PMMA material
- light colour, timer and night light settings functions
- 3 years warranty
- use: interiors in households, offices or hotels

- power: 24 W
- replacement of incandescent bulb: 120 W
- luminous flux: 80-1 920 lm
- color temperature: 2 700-6 500 K
- body material: steel plate
- color rendering index (CRI): Ra > 80
- beam angle: 115°
- type of mounting: surface
- dimensions: 360 × 58 mm in diameter
- dimming function
- body colour: white
- line: ALVI
- warranty period: 3 years



ZM5165 1/-/-/5
15 39 084 002 ZM5165

- power: 36 W
- replacement of incandescent bulb: 170 W
- luminous flux: 140-2 880 lm
- color temperature: 2 700-6 500 K
- body material: steel plate
- color rendering index (CRI): Ra > 80
- beam angle: 115°
- type of mounting: surface
- dimensions: 500 × 60 mm in diameter
- dimming function
- body colour: white
- line: ALVI
- warranty period: 3 years



ZM5166 1/-/-/5
15 39 084 003 ZM5166

- power: 72 W
- replacement of incandescent bulb: 270 W
- luminous flux: 250-5 000 lm
- color temperature: 2 700-6 500 K
- body material: steel plate
- color rendering index (CRI): Ra > 80
- beam angle: 115°
- type of mounting: surface
- dimensions: 884 × 583 × 64 mm
- dimming function
- body colour: silver, white
- line: ALVI
- warranty period: 3 years



ZM5167 1/-/-/2
15 39 087 000 ZM5167

ILVI

EXCLUSIVE

- modern luminaires of premium quality in a circular shape
- very economical and durable LEDs
- fluent dimmig via remote control
- timer function, night light and HALO effect
- 3 years warranty
- use: interiors in households, offices or hotels

- power: 30 W
- replacement of incandescent bulb: 115 W
- luminous flux: 180–1 800 lm
- color temperature: 2 700–6 500 K
- body material: plastic (PS) + steel plate
- color rendering index (CRI): Ra > 80
- beam angle: 120°
- type of mounting: surface
- dimensions: 400 × 70 mm in diameter

- dimming function
- body colour: white
- line: ILVI
- warranty period: 3 years



ZM5168 1/-/-/5
15 39 094 300 ZM5168

- power: 45 W
- replacement of incandescent bulb: 160 W
- luminous flux: 270–2 700 lm
- color temperature: 2 700–6 500 K
- body material: plastic (PS) + steel plate
- color rendering index (CRI): Ra > 80
- beam angle: 120°
- type of mounting: surface
- dimensions: 500 × 70 mm in diameter

- dimming function
- body colour: white
- line: ILVI
- warranty period: 3 years



ZM5169 1/-/-/5
15 39 094 450 ZM5169

LIVI

EXCLUSIVE

- fluent dimming via remote control
- light colour adjustment
- timer and night light function
- 3 years warranty
- use: lighting of modern interiors, offices or hotels

- power: 30 W
- replacement of incandescent bulb: 110 W
- luminous flux: 1 800 lm
- color temperature: 2 700–6 500 K
- body material: steel plate
- color rendering index (CRI): Ra > 80
- beam angle: 115°
- type of mounting: surface
- dimensions: 400 × 85 mm in diameter

- dimming function
- body colour: white
- line: LIVI
- warranty period: 3 years



ZM5162 1/-/-/5
15 39 087 301 ZM5162

- power: 45 W
- replacement of incandescent bulb: 160 W
- luminous flux: 2 700 lm
- color temperature: 2 700–6 500 K
- body material: steel plate
- color rendering index (CRI): Ra > 80
- beam angle: 115°
- type of mounting: surface
- dimensions: 500 × 90 mm in diameter

- dimming function
- body colour: white
- line: LIVI
- warranty period: 3 years



ZM5163
15 39 087 451

1/-/-/5
ZM5163

ILVI GoSmart



- Control via remote control or mobile app
- Adjustment of light intensity and colour
- Timer and night light function
- Connection to the home network via WIFI protocol
- Compatibility with EMOS GoSmart products and TUYA devices
- Voice control with Google Assistant and Amazon Alexa

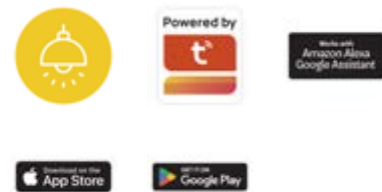

- power: 30 W
- replacement of incandescent bulb: 110 W
- luminous flux: 1 800 lm
- color temperature: 2 700–6 500 K
- body material: steel plate
- color rendering index (CRI): Ra > 80
- beam angle: 115°
- type of mounting: surface
- dimensions: 400 × 70 mm in diameter

- dimming function
- body colour: white
- line: GoSmart
- warranty period: 3 years
- supported OS: Android, iOS
- compatibility: EMOS GoSmart, TUYA, LIDL, Smartlife,
- protocol: Wi-Fi
- transmission frequency: 2.4 GHz Wi-Fi
- control by voice assistants



ZM5191
15 39 087 300

1/-/-/5
ZM5191

- power: 45 W
- replacement of incandescent bulb: 160 W
- luminous flux: 2 700 lm
- color temperature: 2 700–6 500 K
- body material: steel plate
- color rendering index (CRI): Ra > 80
- beam angle: 115°
- type of mounting: surface
- dimensions: 500 × 70 mm in diameter

- dimming function
- body colour: white
- line: GoSmart
- warranty period: 3 years
- supported OS: Android, iOS
- compatibility: EMOS GoSmart, TUYA, LIDL, Smartlife,
- protocol: Wi-Fi
- transmission frequency: 2.4 GHz Wi-Fi
- control by voice assistants



ZM5192
15 39 087 450

1/-/-/5
ZM5192

Luminaires

Surface Luminaires

PROFI

NEXXO

PROFI

- economical surface-mount luminaires
- combination with high quality workmanship
- circular or square shape
- milky diffuser and IP44 degree of protection
- easy installation
- 3 years warranty
- use: corridors in houses, garages, utility rooms

- power: 7.6 W
- replacement of incandescent bulb: 50 W
- luminous flux: 680 lm
- color temperature: 3 000/3 500/4 000 K
- body material: steel plate
- color rendering index (CRI): Ra > 80
- beam angle: 120°
- type of mounting: surface
- dimensions: 120 × 40 mm in diameter

- body colour: white
- line: NEXXO
- warranty period: 3 years

**ZM5123**

1/-/-/8

15 39 087 070

ZM5123

- power: 7.6 W
- replacement of incandescent bulb: 50 W
- luminous flux: 680 lm
- color temperature: 4 000 K
- body material: steel plate
- color rendering index (CRI): Ra > 80
- beam angle: 120°
- type of mounting: surface
- dimensions: 120 × 40 mm in diameter

- body colour: white
- line: NEXXO
- warranty period: 3 years

**ZM5125**

1/-/-/8

15 39 085 070

ZM5125

- power: 12.5 W
- replacement of incandescent bulb: 75 W
- luminous flux: 1 100 lm
- color temperature: 3 000/3 500/4 000 K
- body material: steel plate
- color rendering index (CRI): Ra > 80
- beam angle: 120°
- type of mounting: surface
- dimensions: 170 × 42 mm in diameter

- body colour: white
- line: NEXXO
- warranty period: 3 years

**ZM5133**

1/-/-/8

15 39 087 120

ZM5133

- power: 12.5 W
- replacement of incandescent bulb: 75 W
- luminous flux: 1 100 lm
- color temperature: 4 000 K
- body material: steel plate
- color rendering index (CRI): Ra > 80
- beam angle: 120°
- type of mounting: surface
- dimensions: 170 × 42 mm in diameter

- body colour: white
- line: NEXXO
- warranty period: 3 years



ZM5135 1/-/-/8
15 39 085 120 ZM5135

- power: 21 W
- replacement of incandescent bulb: 120 W
- luminous flux: 1 900 lm
- color temperature: 3 000/3 500/4 000 K
- body material: steel plate
- color rendering index (CRI): Ra > 80
- beam angle: 120°
- type of mounting: surface
- dimensions: 225 × 42 mm in diameter

- body colour: white
- line: NEXXO
- warranty period: 3 years



ZM5143 1/-/-/8
15 39 087 210 ZM5143

- power: 21 W
- replacement of incandescent bulb: 120 W
- luminous flux: 1 900 lm
- color temperature: 4 000 K
- body material: steel plate
- color rendering index (CRI): Ra > 80
- beam angle: 120°
- type of mounting: surface
- dimensions: 225 × 42 mm in diameter

- body colour: white
- line: NEXXO
- warranty period: 3 years



ZM5145 1/-/-/8
15 39 085 210 ZM5145

- power: 28.5 W
- replacement of incandescent bulb: 160 W
- luminous flux: 2 700 lm
- color temperature: 3 000/3 500/4 000 K
- body material: steel plate
- color rendering index (CRI): Ra > 80
- beam angle: 120°
- type of mounting: surface
- dimensions: 300 × 42 mm in diameter

- body colour: white
- line: NEXXO
- warranty period: 3 years



ZM5153 1/-/-/4
15 39 087 280 ZM5153

- power: 28.5 W
- replacement of incandescent bulb: 160 W
- luminous flux: 2 700 lm
- color temperature: 4 000 K
- body material: steel plate
- color rendering index (CRI): Ra > 80
- beam angle: 120°
- type of mounting: surface
- dimensions: 300 × 42 mm in diameter

- body colour: white
- line: NEXXO
- warranty period: 3 years



ZM5155 1/-/-/4
15 39 085 280 ZM5155

- power: 12.5 W
- replacement of incandescent bulb: 75 W
- luminous flux: 1 100 lm
- color temperature: 3 000/3 500/4 000 K
- body material: steel plate
- color rendering index (CRI): Ra > 80
- beam angle: 120°
- type of mounting: surface
- dimensions: 170 × 42 mm in diameter

- body colour: brushed nickel
- line: NEXXO
- warranty period: 3 years



ZM5233 1/-/-/8
15 39 087 121 ZM5233

- power: 21 W
- replacement of incandescent bulb: 120 W
- luminous flux: 1 900 lm
- color temperature: 3 000/3 500/4 000 K
- body material: steel plate
- color rendering index (CRI): Ra > 80
- beam angle: 120°
- type of mounting: surface
- dimensions: 225 × 42 mm in diameter

- body colour: brushed nickel
- line: NEXXO
- warranty period: 3 years



ZM5243 1/-/-/8
15 39 087 211 ZM5243

- power: 28.5 W
- replacement of incandescent bulb: 160 W
- luminous flux: 2 700 lm
- color temperature: 3 000/3 500/4 000 K
- body material: steel plate
- color rendering index (CRI): Ra > 80
- beam angle: 120°
- type of mounting: surface
- dimensions: 300 × 42 mm in diameter

- body colour: brushed nickel
- line: NEXXO
- warranty period: 3 years



ZM5253 1/-/-/4
15 39 087 281 ZM5253

- power: 12.5 W
- replacement of incandescent bulb: 75 W
- luminous flux: 1 100 lm
- color temperature: 3 000/3 500/4 000 K
- body material: steel plate
- color rendering index (CRI): Ra > 80
- beam angle: 120°
- type of mounting: surface
- dimensions: 170 × 42 mm in diameter

- body colour: black
- line: NEXXO
- warranty period: 3 years



ZM5333 1/-/-/8
15 39 087 122 ZM5333

- power: 21 W
- replacement of incandescent bulb: 120 W
- luminous flux: 1 900 lm
- color temperature: 3 000/3 500/4 000 K
- body material: steel plate
- color rendering index (CRI): Ra > 80
- beam angle: 120°
- type of mounting: surface
- dimensions: 225 × 42 mm in diameter

- body colour: black
- line: NEXXO
- warranty period: 3 years



ZM5343 1/-/-/8
15 39 087 212 ZM5343

- power: 28.5 W
- replacement of incandescent bulb: 160 W
- luminous flux: 2 700 lm
- color temperature: 3 000/3 500/4 000 K
- body material: steel plate
- color rendering index (CRI): Ra > 80
- beam angle: 120°
- type of mounting: surface
- dimensions: 300 × 42 mm in diameter

- body colour: black
- line: NEXXO
- warranty period: 3 years



ZM5353 1/-/-/4
15 39 087 282 ZM5353

- power: 7.6 W
- replacement of incandescent bulb: 50 W
- luminous flux: 680 lm
- color temperature: 3 000/3 500/4 000 K
- body material: steel plate
- color rendering index (CRI): Ra > 80
- beam angle: 120°
- type of mounting: surface
- dimensions: 120 × 120 × 40 mm

- body colour: white
- line: NEXXO
- warranty period: 3 years



ZM6123 1/-/-/8
15 39 087 071 ZM6123

- power: 7.6 W
- replacement of incandescent bulb: 50 W
- luminous flux: 680 lm
- color temperature: 4 000 K
- body material: steel plate
- color rendering index (CRI): Ra > 80
- beam angle: 120°
- type of mounting: surface
- dimensions: 120 × 120 × 40 mm

- body colour: white
- line: NEXXO
- warranty period: 3 years



ZM6125 1/-/-/8
15 39 085 071 ZM6125

- power: 12.5 W
- replacement of incandescent bulb: 75 W
- luminous flux: 1 100 lm
- color temperature: 3 000/3 500/4 000 K
- body material: steel plate
- color rendering index (CRI): Ra > 80
- beam angle: 120°
- type of mounting: surface
- dimensions: 170 × 170 × 42 mm

- body colour: white
- line: NEXXO
- warranty period: 3 years



ZM6133 1/-/-/8
15 39 087 123 ZM6133

- power: 12.5 W
- replacement of incandescent bulb: 75 W
- luminous flux: 1 100 lm
- color temperature: 4 000 K
- body material: steel plate
- color rendering index (CRI): Ra > 80
- beam angle: 120°
- type of mounting: surface
- dimensions: 170 × 170 × 42 mm

- body colour: white
- line: NEXXO
- warranty period: 3 years



ZM6135 1/-/-/8
15 39 085 121 ZM6135

- power: 21 W
- replacement of incandescent bulb: 120 W
- luminous flux: 1 900 lm
- color temperature: 3 000/3 500/4 000 K
- body material: steel plate
- color rendering index (CRI): Ra > 80
- beam angle: 120°
- type of mounting: surface
- dimensions: 225 × 225 × 42 mm

- body colour: white
- line: NEXXO
- warranty period: 3 years



ZM6143 1/-/-/8
15 39 087 213 ZM6143

- power: 21 W
- replacement of incandescent bulb: 120 W
- luminous flux: 1 900 lm
- color temperature: 4 000 K
- body material: steel plate
- color rendering index (CRI): Ra > 80
- beam angle: 120°
- type of mounting: surface
- dimensions: 225 × 225 × 42 mm

- body colour: white
- line: NEXXO
- warranty period: 3 years



ZM6145 1/-/-/8
15 39 085 211 ZM6145

- power: 28.5 W
- replacement of incandescent bulb: 160 W
- luminous flux: 2 700 lm
- color temperature: 3 000/3 500/4 000 K
- body material: steel plate
- color rendering index (CRI): Ra > 80
- beam angle: 120°
- type of mounting: surface
- dimensions: 300 × 300 × 42 mm

- body colour: white
- line: NEXXO
- warranty period: 3 years



ZM6153 1/-/-/4
15 39 087 283 ZM6153

- power: 28.5 W
- replacement of incandescent bulb: 160 W
- luminous flux: 2 700 lm
- color temperature: 4 000 K
- body material: steel plate
- color rendering index (CRI): Ra > 80
- beam angle: 120°
- type of mounting: surface
- dimensions: 300 × 300 × 42 mm

- body colour: white
- line: NEXXO
- warranty period: 3 years



ZM6155 1/-/-/4
15 39 085 281 ZM6155

- power: 12.5 W
- replacement of incandescent bulb: 75 W
- luminous flux: 1 100 lm
- color temperature: 3 000/3 500/4 000 K
- body material: steel plate
- color rendering index (CRI): Ra > 80
- beam angle: 120°
- type of mounting: surface
- dimensions: 170 × 170 × 42 mm

- body colour: brushed nickel
- line: NEXXO
- warranty period: 3 years



ZM6233 1/-/-/8
15 39 087 124 ZM6233

- power: 21 W
- replacement of incandescent bulb: 120 W
- luminous flux: 1 900 lm
- color temperature: 3 000/3 500/4 000 K
- body material: steel plate
- color rendering index (CRI): Ra > 80
- beam angle: 120°
- type of mounting: surface
- dimensions: 225 × 225 × 42 mm

- body colour: brushed nickel
- line: NEXXO
- warranty period: 3 years



ZM6243 1/-/-/8
15 39 087 214 ZM6243

- power: 28.5 W
- replacement of incandescent bulb: 50 W
- luminous flux: 2 700 lm
- color temperature: 3 000/3 500/4 000 K
- body material: steel plate
- color rendering index (CRI): Ra > 80
- beam angle: 120°
- type of mounting: surface
- dimensions: 300 × 300 × 42 mm

- body colour: brushed nickel
- line: NEXXO
- warranty period: 3 years



ZM6253 1/-/-/4
15 39 087 284 ZM6253

- power: 12.5 W
- replacement of incandescent bulb: 75 W
- luminous flux: 1 100 lm
- color temperature: 3 000/3 500/4 000 K
- body material: steel plate
- color rendering index (CRI): Ra > 80
- beam angle: 120°
- type of mounting: surface
- dimensions: 170 × 170 × 42 mm

- body colour: black
- line: NEXXO
- warranty period: 3 years



ZM6333 1/-/-/8
15 39 087 125 ZM6333

- power: 21 W
- replacement of incandescent bulb: 120 W
- luminous flux: 1 900 lm
- color temperature: 3 000/3 500/4 000 K
- body material: steel plate
- color rendering index (CRI): Ra > 80
- beam angle: 120°
- type of mounting: surface
- dimensions: 225 × 225 × 42 mm

- body colour: black
- line: NEXXO
- warranty period: 3 years



ZM6343 1/-/-/8
15 39 087 215 ZM6343

- power: 28.5 W
- replacement of incandescent bulb: 160 W
- luminous flux: 2 700 lm
- color temperature: 3 000/3 500/4 000 K
- body material: steel plate
- color rendering index (CRI): Ra > 80
- beam angle: 120°
- type of mounting: surface
- dimensions: 300 × 300 × 42 mm

- body colour: black
- line: NEXXO
- warranty period: 3 years



ZM6353 1/-/-/4
15 39 087 285 ZM6353

TIVI

PROFI

- ceiling lamps with a light source of energy class A
- high luminous efficacy and simple design.
- IP54 enclosure ensures water resistance
- easy installation
- use: indoor and outdoor environment of premises and houses

- power: 5.2 W
- replacement of incandescent bulb: 60 W
- luminous flux: 880 lm
- color temperature: 4 000 K
- body material: steel plate
- color rendering index (CRI): Ra > 80
- beam angle: 120°
- type of mounting: surface
- dimensions: diameter 250 × 70 mm

- body colour: white
- line: TIVI
- warranty period: 5 years



ZM3405 1/-/-2
15 39 085 050 ZM3405

- power: 8.6 W
- replacement of incandescent bulb: 90 W
- luminous flux: 1 440 lm
- color temperature: 4 000 K
- body material: steel plate
- color rendering index (CRI): Ra > 80
- beam angle: 120°
- type of mounting: surface
- dimensions: diameter 320 × 70 mm

- body colour: white
- line: TIVI
- warranty period: 5 years



ZM3406 1/-/-2
15 39 085 080 ZM3406

- power: 11 W
- replacement of incandescent bulb: 115 W
- luminous flux: 1 840 lm
- color temperature: 4 000 K
- body material: steel plate
- color rendering index (CRI): Ra > 80
- beam angle: 120°
- type of mounting: surface
- dimensions: 380 × 70 mm in diameter

- body colour: white
- line: TIVI
- warranty period: 5 years



ZM3407 1/-/-2
15 39 085 110 ZM3407

- power: 12.5 W
- replacement of incandescent bulb: 130 W
- luminous flux: 2 100 lm
- color temperature: 4 000 K
- body material: steel plate
- color rendering index (CRI): Ra > 80
- beam angle: 120°
- type of mounting: surface
- dimensions: 380 × 70 mm in diameter

- body colour: white
- line: TIVI
- warranty period: 5 years



ZM3408 1/-/-2
15 39 085 122 ZM3408

DIONI

PROFI

- design luminaire made of high quality plastic
- possibility to change the light colour temperature and light output during installation
- energy saving
- high IP54 protection guaranteeing water resistance
- 2 colour variants
- possibility of hanging installation with optional accessories
- use: indoor and outdoor environment of all rooms and houses

- power: 15 W
- replacement of incandescent bulb: 110 W
- luminous flux: 1 725 lm
- color temperature: 3 000/4 000/5 700 K
- body material: plastic
- color rendering index (CRI): Ra > 80
- beam angle: 110°
- type of mounting: surface/hanging
- dimensions: diameter 280 × 62 mm

- body colour: white
- line: DIONI
- warranty period: 3 years

**ZM7150**

1/-/-/3

15 39 087 150

C17280-AM-TW-DP

- power: 15 W
- replacement of incandescent bulb: 110 W
- luminous flux: 1 725 lm
- color temperature: 3 000/4 000/5 700 K
- body material: plastic
- color rendering index (CRI): Ra > 80
- beam angle: 110°
- type of mounting: surface/hanging
- dimensions: diameter 280 × 62 mm

- body colour: black
- line: DIONI
- warranty period: 3 years

**ZM7153**

1/-/-/3

15 39 087 151

C17280-AM-TW-DP

- power: 18 W
- replacement of incandescent bulb: 130 W
- luminous flux: 2 160 lm
- color temperature: 3 000/4 000/5 700 K
- body material: plastic
- color rendering index (CRI): Ra > 80
- beam angle: 110°
- type of mounting: surface/hanging
- dimensions: diameter 360 × 65 mm

- body colour: white
- line: DIONI
- warranty period: 3 years

**ZM7151**

1/-/-/3

15 39 087 180

C17360-AM-TW-DP

- power: 18 W
- replacement of incandescent bulb: 110 W
- luminous flux: 2 160 lm
- color temperature: 3 000/4 000/5 700 K
- body material: plastic
- color rendering index (CRI): Ra > 80
- beam angle: 110°
- type of mounting: surface/hanging
- dimensions: diameter 360 × 65 mm

- body colour: black
- line: DIONI
- warranty period: 3 years

**ZM7154**

1/-/-/3

15 39 087 181

C17360-AM-TW-DP

- power: 32 W
- replacement of incandescent bulb: 200 W
- luminous flux: 3 520 lm
- color temperature: 3 000/4 000/5 700 K
- body material: plastic
- color rendering index (CRI): Ra > 80
- beam angle: 110°
- type of mounting: surface/hanging
- dimensions: diameter 410 × 65 mm

- body colour: white
- line: DIONI
- warranty period: 3 years



ZM7152 1/-/-/3
15 39 087 320 C17410-AM-TW-DP

- power: 32 W
- replacement of incandescent bulb: 200 W
- luminous flux: 3 520 lm
- color temperature: 3 000/4 000/5 700 K
- body material: plastic
- color rendering index (CRI): Ra > 80
- beam angle: 110°
- type of mounting: surface/hanging
- dimensions: diameter 410 × 65 mm

- body colour: black
- line: DIONI
- warranty period: 3 years



ZM7155 1/-/-/3
15 39 087 321 C17410-AM-TW-DP

- product: hanging kit
- material: plastic (PC) + metal
- designed for: LED luminaires
- color: white
- packaging: 1 ks, box



ZM9000 1/-/-/2
15 90 900 001 ASP-C17AAA

- product: hanging kit
- material: plastic (PC) + metal
- designed for: LED luminaires
- color: black
- packaging: 1 ks, box



ZM9001 1/-/-/2
15 90 900 002 ASP-C17AAA

Luminaires

Surface Luminaires

CLASSIC

TORI

CLASSIC

- economical surface-mount luminaires
- combination with high quality workmanship
- circular or square shape
- milky diffuser and IP44 protection
- easy installation
- 3 years warranty
- use: corridors in houses, garages, utility rooms

- power: 15 W
- replacement of incandescent bulb: 80 W
- luminous flux: 1 500 lm
- color temperature: 3 000 K
- body material: plastic (PC)
- color rendering index (CRI): Ra > 80
- beam angle: 120°
- type of mounting: surface
- dimensions: 220 × 53 mm in diameter

- body colour: white
- line: TORI
- warranty period: 3 years

**ZM4121**

1/-/-/6

15 39 081 150

ZM4121

- power: 15 W
- replacement of incandescent bulb: 100 W
- luminous flux: 1 500 lm
- color temperature: 4 000 K
- body material: plastic (PC)
- color rendering index (CRI): Ra > 80
- beam angle: 120°
- type of mounting: surface
- dimensions: 220 × 53 mm in diameter

- body colour: white
- line: TORI
- warranty period: 3 years

**ZM4321**

1/-/-/10

15 39 082 150

ZM4321

- power: 24 W
- replacement of incandescent bulb: 145 W
- luminous flux: 2 400 lm
- color temperature: 3 000 K
- body material: plastic (PC)
- color rendering index (CRI): Ra > 80
- beam angle: 120°
- type of mounting: surface
- dimensions: 330 × 53 mm in diameter

- body colour: white
- line: TORI
- warranty period: 3 years

**ZM4122**

1/-/-/4

15 39 081 240

ZM4122

- power: 24 W
- replacement of incandescent bulb: 145 W
- luminous flux: 2 400 lm
- color temperature: 4 000 K
- body material: plastic (PC)
- color rendering index (CRI): Ra > 80
- beam angle: 120°
- type of mounting: surface
- dimensions: 330 × 53 mm in diameter

- body colour: white
- line: TORI
- warranty period: 3 years



ZM4322 1/-/-/4
15 39 082 240 ZM4322

- power: 36 W
- replacement of incandescent bulb: 215 W
- luminous flux: 3 800 lm
- color temperature: 4 000 K
- body material: plastic (PC)
- color rendering index (CRI): Ra > 80
- beam angle: 120°
- type of mounting: surface
- dimensions: 400 × 53 mm

- body colour: white
- line: TORI
- warranty period: 3 years



ZM4325 1/-/-/4
15 39 085 360 ZM4325

- power: 15 W
- replacement of incandescent bulb: 100 W
- luminous flux: 1 500 lm
- color temperature: 3 000 K
- body material: plastic (PC)
- color rendering index (CRI): Ra > 80
- beam angle: 120°
- type of mounting: surface
- dimensions: 220 × 220 × 53 mm

- body colour: white
- line: TORI
- warranty period: 3 years



ZM4123 1/-/-/10
15 39 081 151 ZM4123

- power: 15 W
- replacement of incandescent bulb: 100 W
- luminous flux: 1 500 lm
- color temperature: 4 000 K
- body material: plastic (PC)
- color rendering index (CRI): Ra > 80
- beam angle: 120°
- type of mounting: surface
- dimensions: 220 × 220 × 53 mm

- body colour: white
- line: TORI
- warranty period: 3 years



ZM4323 1/-/-/10
15 39 082 151 ZM4323

- power: 24 W
- replacement of incandescent bulb: 145 W
- luminous flux: 2 400 lm
- color temperature: 3 000 K
- body material: plastic (PC)
- color rendering index (CRI): Ra > 80
- beam angle: 120°
- type of mounting: surface
- dimensions: 330 × 330 × 53 mm

- body colour: white
- line: TORI
- warranty period: 3 years



ZM4124 1/-/-/4
15 39 081 241 ZM4124

- power: 24 W
- replacement of incandescent bulb: 145 W
- luminous flux: 2 400 lm
- color temperature: 4 000 K
- body material: plastic (PC)
- color rendering index (CRI): Ra > 80
- beam angle: 120°
- type of mounting: surface
- dimensions: 330 × 330 × 53 mm

- body colour: white
- line: TORI
- warranty period: 3 years



ZM4324 1/-/-/4
15 39 082 241 ZM4324

- power: 15 W
- replacement of incandescent bulb: 100 W
- luminous flux: 1 500 lm
- color temperature: 4 000 K
- body material: plastic (PC)
- color rendering index (CRI): Ra > 80
- motion sensor: MW
- beam angle: 120°
- sensor detection range: 10 m

- type of mounting: surface
- dimensions: 220 × 53 mm
- body colour: white
- line: TORI
- warranty period: 3 years



ZM4328 1/-/-/6
15 39 085 150 ZM4328

- power: 24 W
- replacement of incandescent bulb: 145 W
- luminous flux: 2 400 lm
- color temperature: 4 000 K
- body material: plastic (PC)
- color rendering index (CRI): Ra > 80
- motion sensor: MW
- beam angle: 120°
- sensor detection range: 10 m

- type of mounting: surface
- dimensions: 330 × 53 mm
- body colour: white
- line: TORI
- warranty period: 3 years



ZM4329 1/-/-/4
15 39 085 240 ZM4329

CORI

CLASSIC

- ceiling luminaires/wall-mounted LED lights
- steel luminaire body with PMMA cover
- warm or neutral light colour
- high luminous efficacy
- conservative design
- integrated design
- 3 years warranty
- use: interiors, offices spaces, hotels, homes

- power: 18 W
- replacement of incandescent bulb: 100 W
- luminous flux: 1 530 lm
- color temperature: 4 000 K
- body material: steel plate
- color rendering index (CRI): Ra > 80
- motion sensor: MW
- beam angle: 120°
- sensor detection range: 6 m

- type of mounting: surface
- dimensions: 360 × 105 mm in diameter
- body colour: white
- line: CORI
- warranty period: 3 years



ZM3412 1/-/-/2
15 39 034 120 ZM3412

- power: 22 W
- replacement of incandescent bulb: 125 W
- luminous flux: 1 980 lm
- color temperature: 4 000 K
- body material: steel plate
- color rendering index (CRI): Ra > 80
- motion sensor: MW
- beam angle: 120°
- sensor detection range: 6 m
- type of mounting: surface
- dimensions: 410 × 115 mm in diameter
- body colour: white
- line: CORI
- warranty period: 3 years



ZM3413

1/-/-6

15 39 034 130

ZM3413

DORI

CLASSIC

- ceiling or wall-mounted round/square shaped luminaires
- high luminous efficacy and simple design
- the luminaires come in two shapes
- IP54 enclosure ensures water resistance
- easy installation
- use: indoor and outdoor environment of premises and houses

- power: 18 W
- replacement of incandescent bulb: 115 W
- luminous flux: 1 800 lm
- color temperature: 4 000 K
- body material: plastic (PC)
- color rendering index (CRI): Ra > 80
- beam angle: 115°
- type of mounting: surface
- dimensions: 280 × 280 × 55 mm
- body colour: white
- line: DORI
- warranty period: 2 years



ZM4311

1/-/-8

15 39 043 050

ZM4311

- power: 24.5 W
- replacement of incandescent bulb: 150 W
- luminous flux: 2 450 lm
- color temperature: 4 000 K
- body material: plastic (PC)
- color rendering index (CRI): Ra > 80
- beam angle: 115°
- type of mounting: surface
- dimensions: 280 × 55 mm in diameter
- body colour: white
- line: DORI
- warranty period: 2 years



ZM4312

1/-/-8

15 39 043 060

ZM4312

- power: 18 W
- replacement of incandescent bulb: 115 W
- luminous flux: 1 800 lm
- color temperature: 4 000 K
- body material: plastic (PC)
- color rendering index (CRI): Ra > 80
- beam angle: 115°
- type of mounting: surface
- dimensions: 280 × 280 × 55 mm
- body colour: white
- line: DORI
- warranty period: 2 years



ZM4313

1/-/-8

15 39 043 070

ZM4313



www.emos.eu

Order Code
Item Number

Packaging
Type

- power: 24.5 W
- replacement of incandescent bulb: 150 W
- luminous flux: 2 450 lm
- color temperature: 4 000 K
- body material: plastic (PC)
- color rendering index (CRI): Ra > 80
- beam angle: 115°
- type of mounting: surface
- dimensions: 280 × 280 × 55 mm

- body colour: white
- line: DORI
- warranty period: 2 years



4 000 K
NEUTRAL
WHITE



ZM4314 1/-/-8
15 39 043 080 ZM4314



ZURI

CLASSIC

- made of high-quality plastic
- 2in1 - possibility to change the colour of the luminaire body
- energy saving
- IP54 protection guarantees water resistance
- 2 colour frames included
- use: indoor and outdoor environment of premises and houses

- power: 14 W
- replacement of incandescent bulb: 70 W
- luminous flux: 1 000 lm
- color temperature: 3 000 K
- body material: plastic (PC)
- color rendering index (CRI): Ra > 80
- beam angle: 120°
- type of mounting: surface
- dimensions: 215 × 80 mm in diameter

- body colour: black/white
- line: ZURI
- warranty period: 2 years



3 000 K
WARM
WHITE



ZM3130 1/-/-6
15 39 071 140 ZM3130



- power: 14 W
- replacement of incandescent bulb: 75 W
- luminous flux: 1 100 lm
- color temperature: 4 000 K
- body material: plastic (PC)
- color rendering index (CRI): Ra > 80
- beam angle: 120°
- type of mounting: surface
- dimensions: 215 × 80 mm in diameter

- body colour: black/white
- line: ZURI
- warranty period: 2 years



4 000 K
NEUTRAL
WHITE



ZM3230 1/-/-6
15 39 072 141 ZM3230



- power: 14 W
- replacement of incandescent bulb: 75 W
- luminous flux: 1 000 lm
- color temperature: 3 000 K
- body material: plastic (PC)
- color rendering index (CRI): Ra > 80
- motion sensor: PIR
- beam angle: 120°
- sensor detection range: 10 m

- type of mounting: surface
- dimensions: 215 × 80 mm in diameter
- body colour: black/white
- line: ZURI
- warranty period: 2 years



3 000 K
WARM
WHITE



ZM3131 1/-/-6
15 39 071 240 ZM3131



- power: 14 W
- replacement of incandescent bulb: 75 W
- luminous flux: 1 100 lm
- color temperature: 4 000 K
- body material: plastic (PC)
- color rendering index (CRI): Ra > 80
- motion sensor: PIR
- beam angle: 120°
- sensor detection range: 10 m

- type of mounting: surface
- dimensions: 215 × 80 mm in diameter
- body colour: black/white
- line: ZURI
- warranty period: 2 years



ZM3231

1/-/-/6

15 39 072 240

ZM3231



QARI

CLASSIC

- made of high-quality plastic
- circular and oval designs
- energy savings
- IP65 enclosure ensures water resistance
- use: indoor and outdoor environment of premises and houses

- power: 20 W
- replacement of incandescent bulb: 120 W
- luminous flux: 1 900 lm
- color temperature: 4 000 K
- body material: plastic (PC)
- color rendering index (CRI): Ra > 80
- beam angle: 120°
- type of mounting: surface
- dimensions: 220 × 78 mm in diameter

- body colour: white
- line: QARI
- warranty period: 2 years



ZM3010

1/-/-/6

15 39 722 000

ZM3010



- power: 20 W
- replacement of incandescent bulb: 120 W
- luminous flux: 1 900 lm
- color temperature: 4 000 K
- body material: plastic (PC)
- color rendering index (CRI): Ra > 80
- beam angle: 120°
- type of mounting: surface
- dimensions: 270 × 145 × 81 mm

- body colour: white
- line: QARI
- warranty period: 2 years



ZM3020

1/-/-/8

15 39 722 010

ZM3020



RORI

CLASSIC

- Residential luminaire with night light function (2 200K)-change function via wall switch
- possibility of changing the colour temperature of the light during installation
- energy saving
- 2 colour variants - white and black
- use: home interiors

- power: 17 W
- replacement of incandescent bulb: 100 W
- luminous flux: 1 400 lm
- color temperature: 2 700/3 500/4 000 K
- body material: steel plate
- color rendering index (CRI): Ra > 90
- beam angle: 110°
- type of mounting: surface
- dimensions: diameter 310 × 75 mm

- body colour: white
- line: RORI
- warranty period: 3 years

**ZM4400**

1/-/-/3

15 39 087 170

CF63 WHITE

- power: 17 W
- replacement of incandescent bulb: 100 W
- luminous flux: 1 100 lm
- color temperature: 2 700/3 500/4 000 K
- body material: steel plate
- color rendering index (CRI): Ra > 90
- beam angle: 110°
- type of mounting: surface
- dimensions: diameter 310 × 75 mm

- body colour: black
- line: RORI
- warranty period: 3 years

**ZM4401**

1/-/-/3

15 39 087 171

CF63 BLACK

Luminaires

Surface Luminaires

ESSENTIAL

RUBIC

ESSENTIAL

- made of high-quality plastic and custom for surface mounting
- long service life with minimal loss of luminosity
- built-in and mounted installation thanks to mounting frame
- high luminous efficiency
- integrated driver
- conservative design
- use: interior lighting in households

- power: 9 W
- replacement of incandescent bulb: 65 W
- luminous flux: 900 lm
- color temperature: 4 000 K
- body material: plastic (PC)
- color rendering index (CRI): Ra > 80
- beam angle: 120°
- type of mounting: surface
- dimensions: 120 × 42 mm in diameter

- body colour: white
- line: RUBIC
- warranty period: 2 years



4 000 K
NEUTRAL
WHITE



ZM5432

1/-/-/36

15 39 085 092

ZM5432

- power: 18 W
- replacement of incandescent bulb: 110 W
- luminous flux: 1 800 lm
- color temperature: 4 000 K
- body material: plastic (PC)
- color rendering index (CRI): Ra > 80
- beam angle: 120°
- type of mounting: surface
- dimensions: 170 × 42 mm in diameter

- body colour: white
- line: RUBIC
- warranty period: 2 years



4 000 K
NEUTRAL
WHITE



ZM5442

1/-/-/24

15 39 085 182

ZM5442

- power: 24 W
- replacement of incandescent bulb: 145 W
- luminous flux: 2 400 lm
- color temperature: 4 000 K
- body material: plastic (PC)
- color rendering index (CRI): Ra > 80
- beam angle: 120°
- type of mounting: surface
- dimensions: 220 × 42 mm in diameter

- body colour: white
- line: RUBIC
- warranty period: 2 years



4 000 K
NEUTRAL
WHITE



ZM5452

1/-/-/12

15 39 085 242

ZM5452

- power: 9 W
- replacement of incandescent bulb: 65 W
- luminous flux: 900 lm
- color temperature: 4 000 K
- body material: plastic (PC)
- color rendering index (CRI): Ra > 80
- beam angle: 120°
- type of mounting: surface
- dimensions: 120 × 120 × 42 mm

- body colour: white
- line: RUBIC
- warranty period: 2 years



4 000 K
NEUTRAL
WHITE



ZM6432
15 39 085 093

1/-/-/36
ZM6432

- power: 18 W
- replacement of incandescent bulb: 110 W
- luminous flux: 1 800 lm
- color temperature: 4 000 K
- body material: plastic (PC)
- color rendering index (CRI): Ra > 80
- beam angle: 120°
- type of mounting: surface
- dimensions: 170 × 170 × 42 mm

- body colour: white
- line: RUBIC
- warranty period: 2 years



4 000 K
NEUTRAL
WHITE



ZM6442
15 39 085 183

1/-/-/24
ZM6442

- power: 24 W
- replacement of incandescent bulb: 145 W
- luminous flux: 2 400 lm
- color temperature: 4 000 K
- body material: plastic (PC)
- color rendering index (CRI): Ra > 80
- beam angle: 120°
- type of mounting: surface
- dimensions: 220 × 220 × 42 mm

- body colour: white
- line: RUBIC
- warranty period: 2 years



4 000 K
NEUTRAL
WHITE



ZM6452
15 39 085 243

1/-/-/12
ZM6452

FIONI

ESSENTIAL

- LED luminaire with 12 W, 18 W and 24 W
- neutral white light colour
- energy saving
- easy installation
- luminous efficacy 100 lm/W

- power: 12 W
- replacement of incandescent bulb: 80 W
- luminous flux: 1 200 lm
- color temperature: 4 000 K
- body material: steel plate
- color rendering index (CRI): Ra > 80
- beam angle: 120°
- type of mounting: surface
- dimensions: 255 × 63 mm in diameter

- body colour: white
- line: FIONI
- warranty period: 2 years



4 000 K
NEUTRAL
WHITE



ZM1120
15 39 085 123

1/-/-/4
ZM1120

- power: 18 W
- replacement of incandescent bulb: 110 W
- luminous flux: 1 800 lm
- color temperature: 4 000 K
- body material: steel plate
- color rendering index (CRI): Ra > 80
- beam angle: 120°
- type of mounting: surface
- dimensions: 330 × 75 mm in diameter

- body colour: white
- line: FIONI
- warranty period: 2 years



4 000 K
NEUTRAL
WHITE



ZM1121 1/-/-/2
15 39 085 184 ZM1121

- power: 24 W
- replacement of incandescent bulb: 150 W
- luminous flux: 2 400 lm
- color temperature: 4 000 K
- body material: steel plate
- color rendering index (CRI): Ra > 80
- beam angle: 120°
- type of mounting: surface
- dimensions: 390 × 80 mm in diameter

- body colour: white
- line: FIONI
- warranty period: 2 years



4 000 K
NEUTRAL
WHITE



ZM1122 1/-/-/2
15 39 085 245 ZM1122

FLORI

ESSENTIAL

- quality luminaire with ceiling illumination
- in two different designs and two different sizes
- 2 colour variants - white and black
- energy saving
- easy installation
- use: home interiors

- power: 18 W
- replacement of incandescent bulb: 115 W
- luminous flux: 1 800 lm
- color temperature: 4 000 K
- body material: plastic
- color rendering index (CRI): Ra > 80
- beam angle: 110°
- type of mounting: surface
- dimensions: diameter 293 × 29 mm

- body colour: white
- line: FLORI
- warranty period: 2 years



4 000 K
NEUTRAL
WHITE



ZM1400 1/-/-/6
15 39 085 186 CL8105-021

- power: 18 W
- replacement of incandescent bulb: 115 W
- luminous flux: 1 800 lm
- color temperature: 4 000 K
- body material: plastic
- color rendering index (CRI): Ra > 80
- beam angle: 110°
- type of mounting: surface
- dimensions: 293 × 293 × 29 mm

- body colour: white
- line: FLORI
- warranty period: 2 years



4 000 K
NEUTRAL
WHITE



ZM1402 1/-/-/6
15 39 085 187 CL8109-031

- power: 18 W
- replacement of incandescent bulb: 115 W
- luminous flux: 1 800 lm
- color temperature: 4 000 K
- body material: plastic
- color rendering index (CRI): Ra > 80
- beam angle: 110°
- type of mounting: surface
- dimensions: diameter 293 × 29 mm

- body colour: black
- line: FLORI
- warranty period: 2 years



4 000 K
NEUTRAL
WHITE



ZM1404 1/-/-/6
15 39 085 188 CL8106-022

- power: 18 W
- replacement of incandescent bulb: 115 W
- luminous flux: 1 800 lm
- color temperature: 4 000 K
- body material: plastic
- color rendering index (CRI): Ra > 80
- beam angle: 110°
- type of mounting: surface
- dimensions: 293 × 293 × 29 mm

- body colour: black
- line: FLORI
- warranty period: 2 years



4 000 K
NEUTRAL
WHITE



ZM1406 1/-/-/6
15 39 085 189 CL8105-021

- power: 22 W
- replacement of incandescent bulb: 130 W
- luminous flux: 2 200 lm
- color temperature: 4 000 K
- body material: plastic
- color rendering index (CRI): Ra > 80
- beam angle: 110°
- type of mounting: surface
- dimensions: diameter 420 × 29 mm

- body colour: white
- line: FLORI
- warranty period: 2 years



4 000 K
NEUTRAL
WHITE



ZM1401 1/-/-/6
15 39 085 220 CL8113-041

- power: 22 W
- replacement of incandescent bulb: 130 W
- luminous flux: 2 200 lm
- color temperature: 4 000 K
- body material: plastic
- color rendering index (CRI): Ra > 80
- beam angle: 110°
- type of mounting: surface
- dimensions: 420 × 420 × 29 mm

- body colour: white
- line: FLORI
- warranty period: 2 years



4 000 K
NEUTRAL
WHITE



ZM1403 1/-/-/6
15 39 085 221 CL8105-021

- power: 22 W
- replacement of incandescent bulb: 130 W
- luminous flux: 2 200 lm
- color temperature: 4 000 K
- body material: plastic
- color rendering index (CRI): Ra > 80
- beam angle: 110°
- type of mounting: surface
- dimensions: diameter 420 × 29 mm

- body colour: black
- line: FLORI
- warranty period: 2 years



4 000 K
NEUTRAL
WHITE



ZM1405 1/-/-/6
15 39 085 222 CL8114-042

- power: 22 W
- replacement of incandescent bulb: 130 W
- luminous flux: 2 200 lm
- color temperature: 4 000 K
- body material: plastic
- color rendering index (CRI): Ra > 80
- beam angle: 110°
- type of mounting: surface
- dimensions: 420 × 420 × 29 mm
- body colour: black
- line: FLORI
- warranty period: 2 years

**ZM1407**

1/-/-/6

15 39 085 223

CL8116-052

Luminaires

Surface Luminaires

Others

ZM9000

1/-/-/2

15 90 900 001

ASP-C17AAA



- product: hanging kit
- material: plastic (PC) + metal
- designed for: LED luminaires
- color: white
- packaging: 1 ks, box

**ZM9001**

1/-/-/2

15 90 900 002

ASP-C17AAA



- product: hanging kit
- material: plastic (PC) + metal
- designed for: LED luminaires
- color: black
- packaging: 1 ks, box



Luminaires

Pendant Luminaires

CLASSIC

CLASSIC

- for bulbs with socket E27
- ideal in combination with filament or vintage bulbs
- attractive design in copper and brass
- possibility to install your own shade
- 3 years warranty
- use: modern interiors, bars, hotels, restaurants

- body material: pressed sheet + aluminium
- type of mounting: hanging
- dimensions: 10 × 100 cm in diameter
- body colour: copper
- warranty period: 3 years

**ZC3000**

1/-/10/20

15 47 300 000

ZC3000

- body material: pressed sheet + aluminium
- type of mounting: hanging
- dimensions: 10 × 100 cm in diameter
- body colour: brass
- warranty period: 3 years

**ZC3100**

1/-/10/20

15 47 310 000

ZC3100

Luminaires

Recessed Luminaires

EXCLUSIVE

SIMMI

EXCLUSIVE

- elegant LED spotlights with tilt option
- have an integrated driver
- in white or with a brushed nickel surface finish
- top-quality and exclusive appearance
- 3 years warranty
- use: indoor and outdoor environment of premises and houses

- power: 5 W
- replacement of incandescent bulb: 50 W
- luminous flux: 450 lm
- color temperature: 3 000 K
- body material: plastic (PC)
- color rendering index (CRI): Ra > 80
- beam angle: 110°
- type of mounting: recessed
- dimensions: 90 × 25 mm in diameter

- mounting hole: 68 mm
- body colour: white
- line: SIMMI
- warranty period: 3 years



ZD3121 1/-/6/60
15 40 115 510 ZD3121

- power: 5 W
- replacement of incandescent bulb: 50 W
- luminous flux: 450 lm
- color temperature: 4 000 K
- body material: plastic (PC)
- color rendering index (CRI): Ra > 80
- beam angle: 110°
- type of mounting: recessed
- dimensions: 90 × 25 mm in diameter

- mounting hole: 68 mm
- body colour: white
- line: SIMMI
- warranty period: 3 years



ZD3122 1/-/6/60
15 40 115 570 ZD3122

- power: 5 W
- replacement of incandescent bulb: 50 W
- luminous flux: 450 lm
- color temperature: 3 000 K
- body material: aluminum
- color rendering index (CRI): Ra > 80
- beam angle: 110°
- type of mounting: recessed
- dimensions: 80 × 25 mm in diameter

- mounting hole: 68 mm
- body colour: brushed nickel
- line: SIMMI
- warranty period: 3 years



ZD3221 1/-/6/60
15 40 125 510 ZD3221

- power: 5 W
- replacement of incandescent bulb: 50 W
- luminous flux: 450 lm
- color temperature: 4 000 K
- body material: aluminum
- color rendering index (CRI): Ra > 80
- beam angle: 110°
- type of mounting: recessed
- dimensions: 80 × 25 mm in diameter

- mounting hole: 68 mm
- body colour: brushed nickel
- line: SIMMI
- warranty period: 3 years



ZD3222 1/-/6/60
15 40 125 570 ZD3222

Luminaires

Recessed Luminaires

PROFI

NEXXO

PROFI

- made of cast aluminium and acrylic glass
- suitable for surface mounting
- high-quality drivers LIFUD
- LGP - PMMA - pleasantly diffused light
- easy installation thanks to the installation console
- 3 years warranty
- use: interiors in homes, offices or hotels.
- use: interior lighting in homes, offices, hotels

- power: 7 W
- replacement of incandescent bulb: 40 W
- luminous flux: 450 lm
- color temperature: 3 000 K
- body material: aluminum
- color rendering index (CRI): Ra > 82
- beam angle: 110°
- type of mounting: recessed
- dimensions: 120 × 21 mm in diameter

- mounting hole: 105 mm
- body colour: white
- line: NEXXO
- warranty period: 3 years



ZD1124 1/-/-/8
15 40 110 613 ZD1124

- power: 7 W
- replacement of incandescent bulb: 40 W
- luminous flux: 480 lm
- color temperature: 4 000 K
- body material: aluminum
- color rendering index (CRI): Ra > 82
- beam angle: 110°
- type of mounting: recessed
- dimensions: 120 × 21 mm in diameter

- mounting hole: 105 mm
- body colour: white
- line: NEXXO
- warranty period: 3 years



ZD1125 1/-/-/8
15 40 110 623 ZD1125

- power: 12.5 W
- replacement of incandescent bulb: 70 W
- luminous flux: 1 000 lm
- color temperature: 3 000 K
- body material: aluminum
- color rendering index (CRI): Ra > 82
- beam angle: 110°
- type of mounting: recessed
- dimensions: 170 × 21 mm in diameter

- mounting hole: 155 mm
- body colour: white
- line: NEXXO
- warranty period: 3 years



ZD1134 1/-/-/8
15 40 111 214 ZD1134

- power: 12.5 W
- replacement of incandescent bulb: 70 W
- luminous flux: 1 050 lm
- color temperature: 4 000 K
- body material: aluminum
- color rendering index (CRI): Ra > 82
- beam angle: 110°
- type of mounting: recessed
- dimensions: 170 × 21 mm in diameter

- mounting hole: 155 mm
- body colour: white
- line: NEXXO
- warranty period: 3 years



ZD1135 1/-/-/8
15 40 111 224 ZD1135

- power: 18 W
- replacement of incandescent bulb: 100 W
- luminous flux: 1 500 lm
- color temperature: 3 000 K
- body material: aluminum
- color rendering index (CRI): Ra > 82
- beam angle: 110°
- type of mounting: recessed
- dimensions: 225 × 21 mm in diameter

- mounting hole: 205 mm
- body colour: white
- line: NEXXO
- warranty period: 3 years



ZD1144 1/-/-/8
15 40 111 813 ZD1144

- power: 18 W
- replacement of incandescent bulb: 100 W
- luminous flux: 1 600 lm
- color temperature: 4 000 K
- body material: aluminum
- color rendering index (CRI): Ra > 82
- beam angle: 110°
- type of mounting: recessed
- dimensions: 225 × 21 mm in diameter

- mounting hole: 205 mm
- body colour: white
- line: NEXXO
- warranty period: 3 years



ZD1145 1/-/-/8
15 40 111 823 ZD1145

- power: 25 W
- replacement of incandescent bulb: 125 W
- luminous flux: 2 000 lm
- color temperature: 3 000 K
- body material: aluminum
- color rendering index (CRI): Ra > 82
- beam angle: 110°
- type of mounting: recessed
- dimensions: 300 × 21 mm in diameter

- mounting hole: 280 mm
- body colour: white
- line: NEXXO
- warranty period: 3 years



ZD1154 1/-/-/4
15 40 112 413 ZD1154

- power: 25 W
- replacement of incandescent bulb: 125 W
- luminous flux: 2 100 lm
- color temperature: 4 000 K
- body material: aluminum
- color rendering index (CRI): Ra > 82
- beam angle: 110°
- type of mounting: recessed
- dimensions: 300 × 21 mm in diameter

- mounting hole: 280 mm
- body colour: white
- line: NEXXO
- warranty period: 3 years



ZD1155 1/-/-/4
15 40 112 423 ZD1155

- power: 7 W
- replacement of incandescent bulb: 40 W
- luminous flux: 480 lm
- color temperature: 3 000/3 500/4 000 K
- body material: aluminum
- color rendering index (CRI): Ra > 82
- beam angle: 110°
- type of mounting: recessed
- dimensions: 120 × 21 mm in diameter

- mounting hole: 105 mm
- body colour: brushed nickel
- line: NEXXO
- warranty period: 3 years



ZD1223 1/-/-/8
15 40 130 670 ZD1223

- power: 12.5 W
- replacement of incandescent bulb: 70 W
- luminous flux: 1 050 lm
- color temperature: 3 000/3 500/4 000 K
- body material: aluminum
- color rendering index (CRI): Ra > 82
- beam angle: 110°
- type of mounting: recessed
- dimensions: 170 × 21 mm in diameter

- mounting hole: 155 mm
- body colour: brushed nickel
- line: NEXXO
- warranty period: 3 years



ZD1233 1/-/-/8
15 40 131 270 ZD1233

- power: 18 W
- replacement of incandescent bulb: 100 W
- luminous flux: 1 600 lm
- color temperature: 3 000/3 500/4 000 K
- body material: aluminum
- color rendering index (CRI): Ra > 82
- beam angle: 110°
- type of mounting: recessed
- dimensions: 225 × 21 mm in diameter

- mounting hole: 205 mm
- body colour: brushed nickel
- line: NEXXO
- warranty period: 3 years



ZD1243 1/-/-/8
15 40 131 870 ZD1243

- power: 7 W
- replacement of incandescent bulb: 40 W
- luminous flux: 480 lm
- color temperature: 3 000/3 500/4 000 K
- body material: aluminum
- color rendering index (CRI): Ra > 82
- beam angle: 110°
- type of mounting: recessed
- dimensions: 120 × 21 mm in diameter

- mounting hole: 105 mm
- body colour: black
- line: NEXXO
- warranty period: 3 years



ZD1323 1/-/-/8
15 40 140 670 ZD1323

- power: 12.5 W
- replacement of incandescent bulb: 70 W
- luminous flux: 1 050 lm
- color temperature: 3 000/3 500/4 000 K
- body material: aluminum
- color rendering index (CRI): Ra > 82
- beam angle: 110°
- type of mounting: recessed
- dimensions: 170 × 21 mm in diameter

- mounting hole: 155 mm
- body colour: black
- line: NEXXO
- warranty period: 3 years



ZD1333 1/-/-/8
15 40 141 270 ZD1333

- power: 18 W
- replacement of incandescent bulb: 100 W
- luminous flux: 1 600 lm
- color temperature: 3 000/3 500/4 000 K
- body material: aluminum
- color rendering index (CRI): Ra > 82
- beam angle: 110°
- type of mounting: recessed
- dimensions: 225 × 21 mm in diameter

- mounting hole: 205 mm
- body colour: black
- line: NEXXO
- warranty period: 3 years



ZD1343 1/-/-/8
15 40 141 870 ZD1343

- power: 7 W
- replacement of incandescent bulb: 40 W
- luminous flux: 450 lm
- color temperature: 3 000 K
- body material: aluminum
- color rendering index (CRI): Ra > 82
- beam angle: 110°
- type of mounting: recessed
- dimensions: 120 × 120 × 21 mm

- mounting hole: 105 × 105 mm
- body colour: white
- line: NEXXO
- warranty period: 3 years



ZD2124 1/-/-/8
15 40 210 612 ZD2124

- power: 7 W
- replacement of incandescent bulb: 40 W
- luminous flux: 480 lm
- color temperature: 4 000 K
- body material: aluminum
- color rendering index (CRI): Ra > 82
- beam angle: 110°
- type of mounting: recessed
- dimensions: 120 × 120 × 21 mm

- mounting hole: 105 × 105 mm
- body colour: white
- line: NEXXO
- warranty period: 3 years

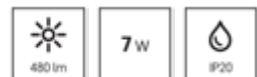

ZD2125 1/-/-/8
15 40 210 622 ZD2125

- power: 12.5 W
- replacement of incandescent bulb: 70 W
- luminous flux: 1 000 lm
- color temperature: 3 000 K
- body material: aluminum
- color rendering index (CRI): Ra > 82
- beam angle: 110°
- type of mounting: recessed
- dimensions: 170 × 170 × 21 mm

- mounting hole: 155 × 155 mm
- body colour: white
- line: NEXXO
- warranty period: 3 years



ZD2134 1/-/-/8
15 40 211 213 ZD2134

- power: 12.5 W
- replacement of incandescent bulb: 70 W
- luminous flux: 1 050 lm
- color temperature: 4 000 K
- body material: aluminum
- color rendering index (CRI): Ra > 82
- beam angle: 110°
- type of mounting: recessed
- dimensions: 170 × 170 × 21 mm

- mounting hole: 155 × 155 mm
- body colour: white
- line: NEXXO
- warranty period: 3 years



ZD2135 1/-/-/8
15 40 211 223 ZD2135

- power: 18 W
- replacement of incandescent bulb: 100 W
- luminous flux: 1 500 lm
- color temperature: 3 000 K
- body material: aluminum
- color rendering index (CRI): Ra > 82
- beam angle: 110°
- type of mounting: recessed
- dimensions: 225 × 225 × 21 mm

- mounting hole: 205 × 205 mm
- body colour: white
- line: NEXXO
- warranty period: 3 years



ZD2144 1/-/-/8
15 40 211 813 ZD2144

- power: 18 W
- replacement of incandescent bulb: 100 W
- luminous flux: 1 600 lm
- color temperature: 4 000 K
- body material: aluminum
- color rendering index (CRI): Ra > 82
- beam angle: 110°
- type of mounting: recessed
- dimensions: 225 × 225 × 21 mm

- mounting hole: 205 × 205 mm
- body colour: white
- line: NEXXO
- warranty period: 3 years



ZD2145 1/-/-/8
15 40 211 823 ZD2145

- power: 25 W
- replacement of incandescent bulb: 125 W
- luminous flux: 2 000 lm
- color temperature: 3 000 K
- body material: aluminum
- color rendering index (CRI): Ra > 82
- beam angle: 110°
- type of mounting: recessed
- dimensions: 300 × 300 × 21 mm

- mounting hole: 280 × 280 mm
- body colour: white
- line: NEXXO
- warranty period: 3 years



ZD2154 1/-/-/4
15 40 212 413 ZD2154

- power: 25 W
- replacement of incandescent bulb: 125 W
- luminous flux: 2 100 lm
- color temperature: 4 000 K
- body material: aluminum
- color rendering index (CRI): Ra > 82
- beam angle: 110°
- type of mounting: recessed
- dimensions: 300 × 300 × 21 mm

- mounting hole: 280 × 280 mm
- body colour: white
- line: NEXXO
- warranty period: 3 years



ZD2155 1/-/-/4
15 40 212 424 ZD2155

- power: 7 W
- replacement of incandescent bulb: 40 W
- luminous flux: 480 lm
- color temperature: 3 000/3 500/4 000 K
- body material: aluminum
- color rendering index (CRI): Ra > 82
- beam angle: 110°
- type of mounting: recessed
- dimensions: 120 × 120 × 21 mm

- mounting hole: 105 × 105 mm
- body colour: brushed nickel
- line: NEXXO
- warranty period: 3 years



ZD2223 1/-/-/8
15 40 230 670 ZD2223

- power: 12.5 W
- replacement of incandescent bulb: 70 W
- luminous flux: 1 050 lm
- color temperature: 3 000/3 500/4 000 K
- body material: aluminum
- color rendering index (CRI): Ra > 82
- beam angle: 110°
- type of mounting: recessed
- dimensions: 170 × 170 × 21 mm

- mounting hole: 155 × 155 mm
- body colour: brushed nickel
- line: NEXXO
- warranty period: 3 years



ZD2233 1/-/-/8
15 40 231 270 ZD2233

- power: 18 W
- replacement of incandescent bulb: 100 W
- luminous flux: 1 600 lm
- color temperature: 3 000/3 500/4 000 K
- body material: aluminum
- color rendering index (CRI): Ra > 82
- beam angle: 110°
- type of mounting: recessed
- dimensions: 225 × 225 × 21 mm

- mounting hole: 205 × 205 mm
- body colour: brushed nickel
- line: NEXXO
- warranty period: 3 years



ZD2243 1/-/-/8
15 40 231 870 ZD2243

- power: 7 W
- replacement of incandescent bulb: 40 W
- luminous flux: 480 lm
- color temperature: 3 000/3 500/4 000 K
- body material: aluminum
- color rendering index (CRI): Ra > 82
- beam angle: 110°
- type of mounting: recessed
- dimensions: 120 × 120 × 21 mm

- mounting hole: 105 × 105 mm
- body colour: black
- line: NEXXO
- warranty period: 3 years



ZD2323 1/-/-/8
15 40 240 670 ZD2323

- power: 12.5 W
- replacement of incandescent bulb: 70 W
- luminous flux: 1 050 lm
- color temperature: 3 000/3 500/4 000 K
- body material: aluminum
- color rendering index (CRI): Ra > 82
- beam angle: 110°
- type of mounting: recessed
- dimensions: 170 × 170 × 21 mm

- mounting hole: 155 × 155 mm
- body colour: black
- line: NEXXO
- warranty period: 3 years



ZD2333 1/-/-/8
15 40 241 270 ZD2333



www.emos.eu

Order Code
Item Number

Packaging
Type

- power: 18 W
- replacement of incandescent bulb: 100 W
- luminous flux: 1 600 lm
- color temperature: 3 000/3 500/4 000 K
- body material: aluminum
- color rendering index (CRI): Ra > 82
- beam angle: 110°
- type of mounting: recessed
- dimensions: 225 × 225 × 21 mm

- mounting hole: 205 × 205 mm
- body colour: black
- line: NEXXO
- warranty period: 3 years



ZD2343 1/-/-/8
15 40 241 870 ZD2343

VIXXO

PROFI

- thin attractive frameless LED luminaires
- high quality aluminium alloy with white exterior finish
- allow easy horizontal and vertical installation
- IP65 enclosure ensures water resistance
- 3 years warranty
- use: bathrooms and toilets, kitchen

- power: 6 W
- replacement of incandescent bulb: 42 W
- luminous flux: 500 lm
- color temperature: 4 000 K
- body material: aluminum
- color rendering index (CRI): Ra > 80
- beam angle: 120°
- type of mounting: recessed
- dimensions: 70 × 20 mm in diameter

- mounting hole: 55 mm
- body colour: white
- line: VIXXO
- warranty period: 3 years



ZV1112 1/-/4/20
15 40 110 621 ZV1112

- power: 7,5 W
- replacement of incandescent bulb: 50 W
- luminous flux: 650 lm
- color temperature: 4 000 K
- body material: aluminum
- color rendering index (CRI): Ra > 80
- beam angle: 120°
- type of mounting: recessed
- dimensions: 100 × 20 mm in diameter

- mounting hole: 80 mm
- body colour: white
- line: VIXXO
- warranty period: 3 years



ZV1122 1/-/4/20
15 40 110 820 ZV1122

- power: 10 W
- replacement of incandescent bulb: 65 W
- luminous flux: 900 lm
- color temperature: 4 000 K
- body material: aluminum
- color rendering index (CRI): Ra > 80
- beam angle: 120°
- type of mounting: recessed
- dimensions: 125 × 20 mm in diameter

- mounting hole: 105 mm
- body colour: white
- line: VIXXO
- warranty period: 3 years



ZV1132 1/-/4/16
15 40 111 120 ZV1132

- power: 13.5 W
- replacement of incandescent bulb: 85 W
- luminous flux: 1 250 lm
- color temperature: 4 000 K
- body material: aluminum
- color rendering index (CRI): Ra > 80
- beam angle: 120°
- type of mounting: recessed
- dimensions: 155 × 20 mm in diameter

- mounting hole: 135 mm
- body colour: white
- line: VIXXO
- warranty period: 3 years



ZV1142 1/-/-/10
15 40 111 520 ZV1142

- power: 19 W
- replacement of incandescent bulb: 110 W
- luminous flux: 1 700 lm
- color temperature: 4 000 K
- body material: aluminum
- color rendering index (CRI): Ra > 80
- beam angle: 120°
- type of mounting: recessed
- dimensions: 185 × 20 mm in diameter

- mounting hole: 165 mm
- body colour: white
- line: VIXXO
- warranty period: 3 years



ZV1152 1/-/-/12
15 40 112 220 ZV1152

- power: 6 W
- replacement of incandescent bulb: 42 W
- luminous flux: 500 lm
- color temperature: 4 000 K
- body material: aluminum
- color rendering index (CRI): Ra > 80
- beam angle: 120°
- type of mounting: recessed
- dimensions: 75 × 75 × 20 mm

- mounting hole: 55 × 55 mm
- body colour: white
- line: VIXXO
- warranty period: 3 years



ZV2112 1/-/4/20
15 40 210 621 ZV2112

- power: 7.5 W
- replacement of incandescent bulb: 50 W
- luminous flux: 650 lm
- color temperature: 4 000 K
- body material: aluminum
- color rendering index (CRI): Ra > 80
- beam angle: 120°
- type of mounting: recessed
- dimensions: 100 × 100 × 20 mm

- mounting hole: 80 × 80 mm
- body colour: white
- line: VIXXO
- warranty period: 3 years



ZV2122 1/-/4/20
15 40 210 820 ZV2122

- power: 10 W
- replacement of incandescent bulb: 65 W
- luminous flux: 900 lm
- color temperature: 4 000 K
- body material: aluminum
- color rendering index (CRI): Ra > 80
- beam angle: 120°
- type of mounting: recessed
- dimensions: 125 × 125 × 20 mm

- mounting hole: 105 × 105 mm
- body colour: white
- line: VIXXO
- warranty period: 3 years



ZV2132 1/-/4/16
15 40 211 120 ZV2132

- power: 13.5 W
- replacement of incandescent bulb: 85 W
- luminous flux: 1 250 lm
- color temperature: 4 000 K
- body material: aluminum
- color rendering index (CRI): Ra > 80
- beam angle: 120°
- type of mounting: recessed
- dimensions: 155 × 155 × 20 mm

- mounting hole: 135 × 135 mm
- body colour: white
- line: VIXXO
- warranty period: 3 years



ZV2142 1/-/-10
15 40 211 520 ZV2142

- power: 19 W
- replacement of incandescent bulb: 110 W
- luminous flux: 1 700 lm
- color temperature: 4 000 K
- body material: aluminum
- color rendering index (CRI): Ra > 80
- beam angle: 120°
- type of mounting: recessed
- dimensions: 185 × 185 × 20 mm

- mounting hole: 165 × 165 mm
- body colour: white
- line: VIXXO
- warranty period: 3 years



ZV2152 1/-/-12
15 40 212 220 ZV2152

GERI

PROFI

- can be tilted up to 90 degrees
- two colour variants
- easy installation
- 3 years warranty
- use: illumination of walls, shelves, paintings

- power: 6.5 W
- replacement of incandescent bulb: 40 W
- luminous flux: 780 lm
- color temperature: 2 700/4 000/6 500 K
- body material: aluminum
- color rendering index (CRI): Ra > 80
- beam angle: 36°
- type of mounting: recessed
- dimensions: diameter 105 × 40 mm

- mounting hole: 87 mm
- dimming function: yes – Triac
- body colour: white
- line: GERI
- warranty period: 3 years



ZV1160 1/-/-20
15 40 116 500 GIMBALL

- power: 6.5 W
- replacement of incandescent bulb: 40 W
- luminous flux: 700 lm
- color temperature: 2 700/4 000/6 500 K
- body material: aluminum
- color rendering index (CRI): Ra > 80
- beam angle: 36°
- type of mounting: recessed
- dimensions: diameter 105 × 40 mm

- mounting hole: 87 mm
- dimming function: yes – Triac
- body colour: black
- line: GERI
- warranty period: 3 years



ZV1161 1/-/-20
15 40 146 500 GIMBALL

Luminaires

Recessed Luminaires

ESSENTIAL

RUBIC

ESSENTIAL

- white are made of high-quality plastic
- designed to be recessed into plasterboard
- long service life with minimal loss of luminosity
- high luminous efficiency
- conservative design
- integrated driver
- use: interior lighting in households

- power: 9 W
- replacement of incandescent bulb: 65 W
- luminous flux: 900 lm
- color temperature: 4 000 K
- body material: plastic (PC)
- color rendering index (CRI): Ra > 80
- beam angle: 120°
- type of mounting: recessed
- dimensions: 120 × 26 mm in diameter

- mounting hole: 90–110 mm
- body colour: white
- line: RUBIC
- warranty period: 2 years



4 000 K
NEUTRAL
WHITE



ZD1432

1/-/-48

15 39 085 090

ZD1432

- power: 18 W
- replacement of incandescent bulb: 110 W
- luminous flux: 1 800 lm
- color temperature: 4 000 K
- body material: plastic (PC)
- color rendering index (CRI): Ra > 80
- beam angle: 120°
- type of mounting: recessed
- dimensions: 170 × 26 mm in diameter

- mounting hole: 140–160 mm
- body colour: white
- line: RUBIC
- warranty period: 2 years



4 000 K
NEUTRAL
WHITE



ZD1442

1/-/-32

15 39 085 180

ZD1442

- power: 24 W
- replacement of incandescent bulb: 145 W
- luminous flux: 2 400 lm
- color temperature: 4 000 K
- body material: plastic (PC)
- color rendering index (CRI): Ra > 80
- beam angle: 120°
- type of mounting: recessed
- dimensions: 220 × 26 mm in diameter

- mounting hole: 190–210 mm
- body colour: white
- line: RUBIC
- warranty period: 2 years



4 000 K
NEUTRAL
WHITE



ZD1452

1/-/-16

15 39 085 244

ZD1452



www.emos.eu

Order Code
Item Number

Packaging
Type

- power: 9 W
- replacement of incandescent bulb: 65 W
- luminous flux: 900 lm
- color temperature: 4 000 K
- body material: plastic (PC)
- color rendering index (CRI): Ra > 80
- beam angle: 120°
- type of mounting: recessed
- dimensions: 120 × 120 × 26 mm

- mounting hole: 90–110 mm
- body colour: white
- line: RUBIC
- warranty period: 2 years



4 000 K
NEUTRAL
WHITE



ZD2432
15 39 085 091

1/-/-/45
ZD2432

- power: 18 W
- replacement of incandescent bulb: 110 W
- luminous flux: 1 800 lm
- color temperature: 4 000 K
- body material: plastic (PC)
- color rendering index (CRI): Ra > 80
- beam angle: 120°
- type of mounting: recessed
- dimensions: 170 × 170 × 26 mm

- mounting hole: 140–160 mm
- body colour: white
- line: RUBIC
- warranty period: 2 years



4 000 K
NEUTRAL
WHITE



ZD2442
15 39 085 181

1/-/-/32
ZD2442

- power: 24 W
- replacement of incandescent bulb: 145 W
- luminous flux: 2 400 lm
- color temperature: 4 000 K
- body material: plastic (PC)
- color rendering index (CRI): Ra > 80
- beam angle: 120°
- type of mounting: recessed
- dimensions: 220 × 220 × 26 mm

- mounting hole: 190–210 mm
- body colour: white
- line: RUBIC
- warranty period: 2 years



4 000 K
NEUTRAL
WHITE



ZD2452
15 39 085 241

1/-/-/16
ZD2452

Luminaires

Emergency Luminaires

PROFI

CESSI

PROFI

- emergency luminaires are used in case of power failure
- ensure safe egress from rooms during a power outage
- sufficient backup power for 3 hours during a power outage
- test button and LED indicator for testing functionality
- 4 years warranty
- use: industrial buildings, garages, hallways, offices

- type of emergency operation test: manual button
- light color: cool white
- IP rating: IP20
- body material: plastic (PC)
- power voltage: 220–240 V AC
- input power: 3 W max.
- dimensions: 315 × 223 × 45 mm
- luminous flux: 30 lm
- color temperature: 5 000 K
- mounting type: attached
- warranty period: 4 years
- backup time: 3 h
- battery type: Ni-Cd
- battery capacity: 900 mAh
- type of emergency light operation: maintained/non-

**ZN1210**

1/-/-/6

15 48 121 000

ZN1210

- body material: plastic (PC)
- dimensions: 386 × 80 × 74 mm
- mounting type: recessed
- warranty period: 4 years

**ZN1211**

1/-/-/8

15 48 121 100

ZN1211

NESSI

PROFI

- emergency luminaires are used in case of power failure
- ensure safe egress from rooms during a power outage
- sufficient backup power for 3 hours during a power outage
- test button and LED indicator for testing functionality
- 4 years warranty
- use: industrial buildings, garages, hallways, offices

- type of emergency operation test: manual button
- light color: cool white
- IP rating: IP65
- body material: plastic (ABS)
- power voltage: 220–240 V AC
- input power: 3 W
- dimensions: 351 × 111 × 63 mm
- luminous flux: 150 lm
- color temperature: 6 500 K
- mounting type: attached
- warranty period: 4 years
- backup time: 3 h
- battery type: LiFePo4
- battery capacity: 1 500 mAh
- type of emergency light operation: maintained/non-



ZN1110 1/-/-/10
15 48 111 000 ZN1110

- body material: steel plate
- dimensions: 387 × 147 × 30 mm
- mounting type: recessed
- warranty period: 4 years



ZN1111 1/-/-/10
15 48 111 100 ZN1111

- IP rating: IP65
- body material: plastic (PC)
- dimensions: 350 × 113 × 192 mm
- warranty period: 4 years



ZN1112 1/-/-/10
15 48 111 200 ZN1112

ORSU

PROFI

- emergency luminaires are used in case of power failure
- ensure safe egress from rooms during a power outage
- sufficient backup power for 3 hours during a power outage
- test button and LED indicator for testing functionality
- 4 years warranty
- use: industrial and warehouse buildings, corridors, offices

- | | |
|---|---|
| ▪ type of emergency operation test: manual button | ▪ mounting type: recessed |
| ▪ light color: cool white | ▪ warranty period: 4 years |
| ▪ IP rating: IP20 | ▪ backup time: 3 h |
| ▪ body material: plastic (PC) | ▪ battery type: LiFePo4 |
| ▪ power voltage: 220-240 V AC | ▪ battery capacity: 1 500 mAh |
| ▪ input power: 3 W | ▪ type of emergency light operation: non-maintained |
| ▪ dimensions: 140 × 55 mm in diameter | |
| ▪ luminous flux: 240 lm | |
| ▪ color temperature: 6 500 K | |



ZN1310 1/-/-/12
15 48 131 000 ZN1310

- body material: plastic (PC)
- dimensions: 140 × 55 mm in diameter
- mounting type: attached
- warranty period: 4 years



ZN1311 1/-/-/12
15 48 131 100 ZN1311

Luminaires

Emergency Luminaires

Emergency conversion kit

- type of emergency operation test: manual button
- IP rating: IP20
- body material: plastic (PC)
- power voltage: 220–240 V AC
- input power: 6 W max.
- dimensions: 212 × 73 × 28 mm
- warranty period: 3 years
- backup time: 1 h
- battery type: LiFePo4
- battery capacity: 1 500 mAh

**ZR9310**

1/-/-/20

15 48 931 000

ZR9310

Luminaires

Orientation Luminaires

CLASSIC

AMAL

CLASSIC

- orientation luminaires in brushed aluminium
- designed for recessed mounting
- the aluminium body and glass milk diffuse
- a superior service life
- minimal power consumption
- IP65 protection guarantees water resistance
- in neutral or warm white
- use: stairs, exterior facades, walls

- colour: stainless steel
- light color: warm white
- IP rating: IP65
- material of the diffuser: glass
- body material: aluminum
- mounting hole: 113 × 43 × 65 mm
- voltage: 220-240 V
- packaging: 1 pc, box
- power: 1.5 W

- dimensions: 123 × 53 × 61 mm
- luminous flux: 55 lm
- color temperature: 3 000 K
- source of light: LED
- lifetime: 30 000 hours

**ZC0108**

1/-/-/24

15 45 000 080

ZC0108

- colour: stainless steel
- light color: neutral white
- IP rating: IP65
- material of the diffuser: glass
- body material: aluminum
- mounting hole: 113 × 43 × 65 mm
- voltage: 220-240 V
- packaging: 1 pc, box
- power: 1.5 W

- dimensions: 123 × 53 × 61 mm
- luminous flux: 55 lm
- color temperature: 4 000 K
- source of light: LED
- lifetime: 30 000 hours

**ZC0110**

1/-/-/24

15 45 000 100

ZC0110

- colour: stainless steel
- light color: warm white
- IP rating: IP65
- material of the diffuser: glass
- body material: aluminum
- mounting hole: 75 × 70 mm
- voltage: 220-240 V
- packaging: 1 pc, box
- power: 1.5 W

- dimensions: 80 × 80 × 61 mm
- luminous flux: 75 lm
- color temperature: 3 000 K
- source of light: LED
- lifetime: 30 000 hours

**ZC0109**

1/-/-/24

15 45 000 090

ZC0109

- colour: stainless steel
- light color: neutral white
- IP rating: IP65
- material of the diffuser: glass
- body material: aluminum
- mounting hole: 75 × 70 mm
- voltage: 220–240 V
- packaging: 1 pc, box
- power: 2 W

- dimensions: 80 × 80 × 61 mm
- luminous flux: 70 lm
- color temperature: 4 000 K
- source of light: LED
- lifetime: 30 000 hours



4 000 K
NEUTRAL
WHITE



ZC0111 1/-/-/24
15 45 000 110 ZC0111

DIRAL

CLASSIC

- in several shapes and sizes
- designed for recessed mounting
- the aluminium body and glass milk diffuser
- a superior service life
- IP65 protection guarantees water resistance
- for indoor and outdoor areas
- use: stairs, exteriors facades, walls

- colour: grey
- light color: warm white
- IP rating: IP65
- material of the diffuser: glass
- body material: aluminum
- mounting hole: 80 × 75 mm
- voltage: 220–240 V
- packaging: 1 pc, box
- power: 1 W

- dimensions: 90 × 90 × 71 mm
- luminous flux: 25 lm
- color temperature: 3 000 K
- source of light: LED
- lifetime: 30 000 hours



3 000 K
WARM
WHITE



ZC0105 1/-/-/16
15 45 000 050 ZC0105

- colour: grey
- light color: warm white
- IP rating: IP65
- material of the diffuser: glass
- body material: aluminum
- mounting hole: 125 × 58 mm
- voltage: 220–240 V
- packaging: 1 pc, box
- power: 3 W

- dimensions: 140 × 70 × 71 mm
- luminous flux: 90 lm
- color temperature: 3 000 K
- source of light: LED
- lifetime: 30 000 hours



3 000 K
WARM
WHITE



ZC0106 1/-/-/16
15 45 000 060 ZC0106

DIRBI

CLASSIC

- orientation luminaires for surface-mounted installation
- excellent price/quality ratio
- the ABS plastic body and polycarbonate diffuser
- a long service life
- minimal power consumption
- for indoor and outdoor areas
- IP65 protection guarantees water resistance
- use: stairs, exterior facades, walls

- colour: dark grey
- light color: neutral white
- IP rating: IP65
- material of the diffuser: polycarbonate
- body material: ABS
- voltage: 220–240 V
- packaging: 1 pc, box
- power: 3 W
- dimensions: 120 × 120 × 32 mm

- luminous flux: 100 lm
- color temperature: 4 000 K
- source of light: LED
- lifetime: 30 000 hours

4 000 K
NEUTRAL
WHITE

8 592920 075586

ZC0114

1/-/-/18

15 45 000 140

ZC0114

- colour: dark grey
- light color: neutral white
- IP rating: IP65
- material of the diffuser: polycarbonate
- body material: ABS
- voltage: 220–240 V
- packaging: 1 pc, box
- power: 1.5 W
- dimensions: 100 × 60 × 33 mm

- luminous flux: 80 lm
- color temperature: 4 000 K
- source of light: LED
- lifetime: 30 000 hours

4 000 K
NEUTRAL
WHITE

8 592920 075609

ZC0116

1/-/-/40

15 45 000 160

ZC0116

- colour: dark grey
- light color: neutral white
- IP rating: IP65
- material of the diffuser: polycarbonate
- body material: ABS
- voltage: 220–240 V
- packaging: 1 pc, box
- power: 3 W
- dimensions: 160 × 70 × 33 mm

- luminous flux: 150 lm
- color temperature: 4 000 K
- source of light: LED
- lifetime: 30 000 hours

4 000 K
NEUTRAL
WHITE

8 592920 075616

ZC0117

1/-/-/30

15 45 000 170

ZC0117

Luminaires

Cabinet Luminaires

CLASSIC

TIGO

CLASSIC

- energy-saving LED bars for embellishing a closet or kitchen unit
- lengths from 300 mm to 1 150 mm
- option to interconnect different lengths
- neutral white colour temperature
- simple installation

- power: 5 W
- length: 300 mm
- luminous flux: 500 lm
- color temperature: 4 000 K
- light color: neutral white
- material: aluminium (Al) + plastic
- dimensions: 300 × 22 × 30 mm
- lifetime: 25 000 hours
- beam angle: 120°

= packaging: 1 pc, small box

4 000 K
NEUTRAL
WHITE**ZS2110**

15 31 211 010

1/-/-/30

ZS2110

- power: 10 W
- length: 600 mm
- luminous flux: 1 000 lm
- color temperature: 4 000 K
- light color: neutral white
- material: aluminium (Al) + plastic
- dimensions: 600 × 22 × 30 mm
- lifetime: 25 000 hours
- beam angle: 120°

= packaging: 1 pc, small box

4 000 K
NEUTRAL
WHITE**ZS2120**

15 31 211 020

1/-/-/30

ZS2120

- power: 15 W
- length: 860 mm
- luminous flux: 1 500 lm
- color temperature: 4 000 K
- light color: neutral white
- material: aluminium (Al) + plastic
- dimensions: 860 × 22 × 30 mm
- lifetime: 25 000 hours
- beam angle: 120°

= packaging: 1 pc, small box

4 000 K
NEUTRAL
WHITE**ZS2130**

15 31 211 030

1/-/-/30

ZS2130

- power: 20 W
 - length: 1 150 mm
 - luminous flux: 2 000 lm
 - color temperature: 4 000 K
 - light color: neutral white
 - material: aluminium (Al) + plastic
 - dimensions: 1 150 × 22 × 30 mm
 - lifetime: 25 000 hours
 - beam angle: 120°
- = packaging: 1 pc, small box



4 000 K
NEUTRAL
WHITE



ZS2140
15 31 211 040

1/-/-/30
ZS2140

Luminaires

Desk and Floor Lamps

- stylish table or floor lamps
- suitable for the study or children's room
- selected models allow wireless charging of mobile phones,
- night light function, timer or dimming function
- retro lamps with E27 base

- model: MIA
 - power: 5.6 W
 - luminous flux: 150 lm
 - colour: black
 - supply cable length: 1 m
 - power adaptor: USB
 - power adaptor included: yes (USB cable)
 - color temperature: 3 000/5 000/6 500 K
 - dimensions: 30 cm
- = color rendering index (CRI): Ra >95
= packaging: 1 pc, box



Z7625
15 38 189 000

1/-/-/20
Z7625

- model: LUCY
 - power: 2 W
 - luminous flux: 100 lm
 - colour: white
 - supply cable length: 1 m
 - power adaptor: USB cable
 - power adaptor included: yes (USB cable)
 - color temperature: 5 000 K
 - dimensions: 80 × 80 × 300 mm
- = color rendering index (CRI): Ra >80
= packaging: 1 pc, box



Z7626
15 38 190 000

1/-/-/6
Z7626

- model: EMILY
- power: 2 W
- luminous flux: 100 lm
- colour: white
- supply cable length: 1 m
- power adaptor: USB cable
- power adaptor included: yes (USB cable)
- color temperature: 5 000 K
- dimensions: 80 × 80 × 300 mm

- color rendering index (CRI): Ra >80
- packaging: 1 pc, box



Z7627 1/-/-16
15 38 191 000 Z7627



- model: CHARLES
- power: 7.6 W
- luminous flux: 550 lm
- colour: white
- supply cable length: 1.3 m
- power adaptor: 12 V/450 mA
- power adaptor included
- color temperature: 3 000-6 500 K
- dimensions: 420 × 165 × 165 mm

- color rendering index (CRI): Ra >80
- packaging: 1 pc, box

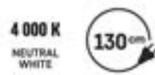
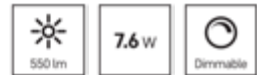

Z7628W 1/-/-2
15 38 192 000 Z7628W



- model: CHARLES
- power: 7.6 W
- luminous flux: 550 lm
- colour: black
- supply cable length: 1.3 m
- power adaptor: 12 V/450 mA
- power adaptor included
- color temperature: 3 000-6 500 K
- dimensions: 420 × 165 × 165 mm

- color rendering index (CRI): Ra >80
- packaging: 1 pc, box



Z7628B 1/-/-2
15 38 193 000 Z7628B



- model: LILY
- power: 13.5
- luminous flux: 760 lm
- colour: white
- supply cable length: 1.5 m
- power adaptor: 10 V/1 A
- power adaptor included
- color temperature: 3 000/4 000/6 500 K
- dimensions: 330 × 130 × 150 mm

- color rendering index (CRI): Ra > 90
- packaging: 1 pc, box



Z7629W 1/-/-4
15 38 194 000 Z7629W



- model: LILY
- power: 13.5
- luminous flux: 760 lm
- colour: black
- supply cable length: 1.5 m
- power adaptor: 10 V/1 A
- power adaptor included
- color temperature: 3 000/4 000/6 500 K
- dimensions: 330 × 130 × 150 mm

- color rendering index (CRI): Ra > 90
- packaging: 1 pc, box



Z7629B 1/-/-4
15 38 195 000 Z7629B



- model: KATIE
- power: 4 W
- luminous flux: 250 lm
- colour: white
- supply cable length: 1.5 m
- power adaptor: 5 V/1 A
- power adaptor included
- color temperature: 3 000/4 000/5 000 K
- dimensions: 330 × 130 × 150 mm

• packaging: 1 pc, box



Z7630W
15 38 196 000

1/-/-/2
Z7630W

- model: KATIE
- power: 4 W
- luminous flux: 250 lm
- colour: black
- supply cable length: 1.5 m
- power adaptor: 5 V/1 A
- power adaptor included
- color temperature: 3 000/4 000/5 000 K
- dimensions: 330 × 130 × 150 mm

• packaging: 1 pc, box



Z7630B
15 38 197 000

1/-/-/2
Z7630B

- model: AVA
- power: 5.6 W
- luminous flux: 200 lm
- colour: black
- supply cable length: 1.5 m
- power adaptor: USB cable
- power adaptor included: yes (USB cable)
- color temperature: 3 000/4 000/5 000 K
- dimensions: 460 × 105 × 53 mm

• color rendering index (CRI): Ra >95
• packaging: 1 pc, box



Z7617
15 38 179 000

1/-/-/10
Z7617

- model: CARSON
- power: 6 W
- luminous flux: 400 lm
- colour: black
- supply cable length: 1.5 m
- power adaptor: 12 V/1 000 mA
- power adaptor included
- color temperature: 2 700–6 600 K
- dimensions: 330 × 290 mm

• USB port
• color rendering index (CRI): Ra >80
• packaging: 1 pc, box



Z7618B
15 38 180 000

1/-/-/6
Z7618B

- model: CARSON
- power: 6 W
- luminous flux: 400 lm
- colour: white
- supply cable length: 1.5 m
- power adaptor: 12 V/1 000 mA
- power adaptor included
- color temperature: 2 700–6 600 K
- dimensions: 330 × 290 mm

• USB port
• color rendering index (CRI): Ra >80
• packaging: 1 pc, box



Z7618W
15 38 181 000

1/-/-/6
Z7618W

- model: CHASE
- power: 7.8 W
- luminous flux: 450 lm
- colour: black
- supply cable length: 1.5 m
- power adaptor: 12 V/500 mA
- power adaptor included
- color temperature: 2 700–6 500 K
- dimensions: 370 × 340 mm

- color rendering index (CRI): Ra >80
- packaging: 1 pc, box



Z7619B
15 38 182 000

1/-/-/8
Z7619B

- model: CHASE
- power: 7.8 W
- luminous flux: 450 lm
- colour: white
- supply cable length: 1.5 m
- power adaptor: 12 V/500 mA
- power adaptor included
- color temperature: 2 700–6 500 K
- dimensions: 370 × 340 mm

- color rendering index (CRI): Ra >80
- packaging: 1 pc, box



Z7619W
15 38 183 000

1/-/-/8
Z7619W

- model: WESLEY
- power: 12 W
- luminous flux: 700 lm
- colour: black
- supply cable length: 1.5 m
- power adaptor: 15 V/800 mA
- power adaptor included
- color temperature: 2 700–6 000 K
- dimensions: 430 × 180 mm

- color rendering index (CRI): Ra >95
- packaging: 1 pc, box



Z7620B
15 38 184 000

1/-/-/2
Z7620B

- model: WESLEY
- power: 12 W
- luminous flux: 700 lm
- colour: white
- supply cable length: 1.5 m
- power adaptor: 15 V/800 mA
- power adaptor included
- color temperature: 2 700–6 000 K
- dimensions: 430 × 180 mm

- color rendering index (CRI): Ra >95
- packaging: 1 pc, box



Z7620W
15 38 185 000

1/-/-/2
Z7620W

- model: KAREN
- power: 9.2 W
- luminous flux: 640 lm
- colour: black
- supply cable length: 1,3 m
- power adaptor: USB cable
- power adaptor included: yes (USB cable)
- color temperature: 3 000/4 000/6 000 K
- dimensions: 200 × 550 × 700 mm

- USB port: no + wireless charging
- color rendering index (CRI): Ra >80
- packaging: 1 pc, box



Z7615
15 38 176 000

1/-/-/5
Z7615

- model: STELLA
- power: 6.5 W
- luminous flux: 400 lm
- colour: blue
- supply cable length: 1.7 m
- power adaptor: 12 V/400 mA
- power adaptor included
- number of LED: 12
- color temperature: 4 000 K

- dimensions: 160 × 550 × 345 mm
- color rendering index (CRI): Ra >80
- packaging: 1 pc, box



Z7602BL

1/-/-/4

15 38 157 000

Z7602BL

- model: STELLA
- power: 6.5 W
- luminous flux: 400 lm
- colour: pink
- supply cable length: 1.7 m
- power adaptor: 12 V/400 mA
- power adaptor included
- number of LED: 12
- color temperature: 4 000 K

- dimensions: 160 × 550 × 345 mm
- color rendering index (CRI): Ra >80
- packaging: 1 pc, box



Z7602P

1/-/-/4

15 38 156 000

Z7602P

- model: STELLA
- power: 6.5 W
- luminous flux: 400 lm
- colour: black
- supply cable length: 1.7 m
- power adaptor: 12 V/400 mA
- power adaptor included
- color temperature: 4 000 K
- dimensions: 160 × 550 × 345 mm

- color rendering index (CRI): Ra >80
- packaging: 1 pc, box



Z7602B

1/-/-/4

15 38 155 000

Z7602B

- model: STELLA
- power: 6.5 W
- luminous flux: 400 lm
- colour: white
- supply cable length: 1.7 m
- power adaptor: 12 V/400 mA
- power adaptor included
- number of LED: 12
- color temperature: 4 000 K

- dimensions: 160 × 550 × 345 mm
- color rendering index (CRI): Ra >80
- packaging: 1 pc, box

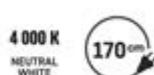

Z7602W

1/-/-/4

15 38 154 000

Z7602W

- model: EDDY
- power: 6 W
- luminous flux: 480 lm
- colour: white
- supply cable length: 1.8 m
- power adaptor: 12 V/0.36 A
- power adaptor included
- number of LED: 24
- color temperature: 3 000/4 500/6 800 K

- dimensions: 170 × 105 × 350 mm
- color rendering index (CRI): Ra > 83
- packaging: 1 pc, box



Z7599W

1/-/-/6

15 38 150 201

Z7599W

- model: EDDY
- power: 6 W
- luminous flux: 480 lm
- colour: black
- supply cable length: 1.8 m
- power adaptor: 12 V/0.36 A
- power adaptor included
- number of LED: 24
- color temperature: 3 000/4 500/6 800 K

- dimensions: 170 × 105 × 350 mm
- color rendering index (CRI): Ra > 83
- packaging: 1 pc, box



Z7599B 1/-/-/6
15 38 150 200 Z7599B

- model: JULIAN
- colour: black
- supply cable length: 1.5 m
- power adaptor: 220-240 V
- dimensions: 460 × 200 mm
- packaging: 1 pc, box



Z7621B 1/-/-/2
15 38 186 000 Z7621B

- model: JULIAN
- colour: white
- supply cable length: 1.5 m
- power adaptor: 220-240 V
- dimensions: 460 × 200 mm
- packaging: 1 pc, box



Z7621W 1/-/-/2
15 38 187 000 Z7621W

- model: JULIAN
- colour: blue
- supply cable length: 1.5 m
- power adaptor: 220-240 V
- dimensions: 460 × 200 mm
- packaging: 1 pc, box



Z7621BL 1/-/-/2
15 38 188 000 Z7621BL

- model: LUCAS
- colour: white
- supply cable length: 1.5 m
- power adaptor: 220-240 V
- dimensions: 480 × 155 × 330 mm
- packaging: 1 pc, box



Z7609W 1/-/-/2
15 38 169 000 Z7609W

- model: ARTHUR
- colour: dark grey
- supply cable length: 1.8 m
- power adaptor: 220–240 V
- dimensions: 850 × 280 × 1 510 mm
- packaging: 1 pc, box

**Z7610**

1/-/-/1

15 38 170 000

Z7610

Sensors

- products with PIR and MW technology
- MW sensors are less demanding on placement than PIR
- also function as switches for lights, outdoor floodlights or alarms
- detection angle of either 180° or 360° and range of 6–12 m
- selected products can also send a command to open doors or gate

- detection angle: 360°
- detection distance: 6 m
- switching time: 5 s, 30 s, 1 min, 3 min, 5 min, 8 min
- IP rating: IP20
- sensor type: PIR
- power source: 230 V~/50 Hz
- max. resistive load: 800 W
- packaging: 1 pc, small box

**G1110**

1/-/-/80

14 54 007 100

G1110

- detection angle: 180°
- detection distance: 12 m
- switching time: min. 10 seconds – max. 7 minutes
- IP rating: IP44
- sensor type: PIR
- power source: 230 V~/50 Hz
- max. resistive load: 1200 W
- packaging: 1 pc, small box

**G1120**

1/-/-/40

14 54 007 200

G1120

- detection angle: 180°
- detection distance: 12 m
- switching time: min. 10 seconds – max. 7 minutes
- IP rating: IP44
- sensor type: PIR
- power source: 230 V~/50 Hz
- max. resistive load: 1200 W
- packaging: 1 pc, small box

**G1125**

1/-/-/40

14 54 007 250

G1125

- detection angle: 360°
- detection distance: 6 m
- switching time: min. 10 seconds – max. 7 minutes
- IP rating: IP20
- sensor type: PIR
- power source: 230 V~/50 Hz
- max. resistive load: 1200 W
- packaging: 1 pc, small box



G1130 1/-/-/20
14 54 008 100 G1130

- detection angle: 360°
- detection distance: 6 m
- switching time: min. 10 sekunds – max. 15 minutes
- IP rating: IP20
- sensor type: PIR
- power source: 230 V~/50 Hz
- max. resistive load: 2 000 W
- packaging: 1 pc, small box



G1150 1/-/-/20
14 54 009 200 G1150

- detection angle: 360°
- detection distance: 6 m
- switching time: min. 10 sekunds – max. 15 minutes
- IP rating: IP20
- sensor type: PIR
- power source: 230 V~/50 Hz
- max. resistive load: 1200 W
- packaging: 1 pc, small box



G1160 1/-/-/36
14 54 010 100 G1160

- detection angle: 180°
- detection distance: 12 m
- switching time: min. 10 sekunds – max. 15 minutes
- IP rating: IP65
- sensor type: PIR
- power source: 230 V~/50 Hz
- max. resistive load: 1200 W
- packaging: 1 pc, small box



G1240 1/-/-/40
14 54 015 100 G1240

- detection angle: 360°
- detection distance: 8 m
- switching time: min. 10 seconds – max. 12 minutes
- IP rating: IP20
- sensor type: microwave
- power source: 230 V~/50 Hz
- max. resistive load: 1200 W
- packaging: 1 pc, small box



G1180 1/-/-/24
14 54 012 100 G1180

- detection angle: 360°
- detection distance: 8 m
- switching time: min. 10 seconds – max. 12 minutes
- IP rating: IP20
- sensor type: microwave
- power source: 230 V~/50 Hz
- max. resistive load: 1200 W
- packaging: 1 pc, small box



G1190 1/-/-/24
14 54 013 100 G1190

- detection angle: 360°
- detection distance: 15 m
- switching time: min. 10 seconds – max. 12 minutes
- IP rating: IP20
- sensor type: microwave
- power source: 230 V~/50 Hz
- max. resistive load: 1200 W
- packaging: 1 pc, small box



G1210 1/-/-/80
15 54 014 100 G1210

Decorations

Smart chains

Chains GoSmart

- 64 lighting modes for a festive atmosphere
- Timer function for scheduled on/off
- Music synchronization for rhythmic blinking
- Various lengths 8–24 m, suitable for both indoor and outdoor use
- Connection to the home network via Wi-Fi protocol
- Compatibility with EMOS GoSmart products and TUYA devices
- Voice control with Google Assistant and Amazon Alexa

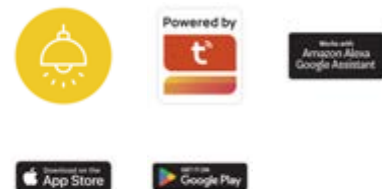

- product: chain
- light color: RGB
- dimensions: 8 m
- area of use: both outdoor and indoor
- timer
- remote control: no
- number of LED: 80
- supply line length: 5 m
- power: 8.4 W
- IP rating: IP44
- lifetime: 10 000 hours
- supported OS: Android, iOS
- compatibility: EMOS GoSmart, TUYA, LIDL, Smartlife,
- protocol: Wi-Fi
- transmission frequency: 2,4 GHz Wi-Fi
- control by voice assistants
- notifications to the mobile app
- application languages: EN, CZ, SK, PL, DE, HU, SI, FR,



D4ZR01 1/-/-/30
15 50 044 028 D4ZR01



www.emos.eu

Order Code
Item Number

Packaging
Type

- product: chain
- light color: RGB
- dimensions: 12 m
- area of use: both outdoor and indoor
- timer
- remote control: no
- number of LED: 120
- supply line length: 5 m
- power: 8.4 W

- IP rating: IP44
- lifetime: 10 000 hours
- supported OS: Android, iOS
- compatibility: EMOS GoSmart, TUYA, LIDL, Smartlife,
- protocol: Wi-Fi
- transmission frequency: 2,4 GHz Wi-Fi
- control by voice assistants
- notifications to the mobile app
- application languages: EN, CZ, SK, PL, DE, HU, SI, FR,



D4ZR02 1/-/-/25
15 50 044 029 D4ZR02

- product: chain
- light color: RGB
- dimensions: 18 m
- area of use: both outdoor and indoor
- timer
- remote control: no
- number of LED: 180
- supply line length: 5 m
- power: 8.4 W

- IP rating: IP44
- lifetime: 10 000 hours
- supported OS: Android, iOS
- compatibility: EMOS GoSmart, TUYA, LIDL, Smartlife,
- protocol: Wi-Fi
- transmission frequency: 2,4 GHz Wi-Fi
- control by voice assistants
- notifications to the mobile app
- application languages: EN, CZ, SK, PL, DE, HU, SI, FR,



D4ZR03 1/-/-/20
15 50 044 030 D4ZR03

- product: chain
- light color: RGB
- dimensions: 24 m
- area of use: both outdoor and indoor
- timer
- remote control: no
- number of LED: 240
- supply line length: 5 m
- power: 8.4 W

- IP rating: IP44
- lifetime: 10 000 hours
- supported OS: Android, iOS
- compatibility: EMOS GoSmart, TUYA, LIDL, Smartlife,
- protocol: Wi-Fi
- transmission frequency: 2,4 GHz Wi-Fi
- control by voice assistants
- notifications to the mobile app
- application languages: EN, CZ, SK, PL, DE, HU, SI, FR,





















D4ZR04 1/-/-/16
15 50 044 031 D4ZR04

Decorations

Decorations

Party

<p>DCPW01</p> <p>15 50 000 000</p>  <p>8 592920 093207</p> <ul style="list-style-type: none"> product: garland light color: warm white dimensions: 5 m area of use: both outdoor and indoor timer: no remote control: no 	<p>1/-/-/6</p> <p>ZY1939</p>   <ul style="list-style-type: none"> number of LED: 50 supply line length: 5 m power: 5 W IP rating: IP44 lifetime: 10 000 hours 		<p>DCPW02</p> <p>15 50 000 001</p>  <p>8 592920 093214</p> <ul style="list-style-type: none"> product: garland light color: warm white dimensions: 5 m area of use: both outdoor and indoor timer: no remote control: no 	<p>1/-/-/6</p> <p>ZY2053</p>   <ul style="list-style-type: none"> number of LED: 50 supply line length: 5 m power: 6 W IP rating: IP44 lifetime: 10 000 hours 	
<p>DCPV01</p> <p>15 50 001 023</p>  <p>8 592920 099070</p> <ul style="list-style-type: none"> product: garland light color: vintage dimensions: 4.5 m area of use: both outdoor and indoor timer: no remote control: no 	<p>1/-/-/8</p> <p>DCPV01</p>   <ul style="list-style-type: none"> number of LED: 100 supply line length: 5 m power: 5 W IP rating: IP44 lifetime: 10 000 hours 		<p>DCPM01</p> <p>15 50 004 000</p>  <p>8 592920 094013</p> <ul style="list-style-type: none"> product: garland light color: multicolor dimensions: 5 m area of use: both outdoor and indoor timer: no remote control: no 	<p>1/-/-/6</p> <p>ZY1938</p>   <ul style="list-style-type: none"> number of LED: 50 supply line length: 5 m power: 6 W IP rating: IP44 lifetime: 10 000 hours 	
<p>DCPZ01</p> <p>15 50 005 000</p>  <p>8 592920 094020</p> <ul style="list-style-type: none"> dimensions: 7.35 m area of use: both outdoor and indoor timer: no remote control: no supply line length: 5 m power: 750 W max. 	<p>1/-/-/2</p> <p>ZY2293</p>   <ul style="list-style-type: none"> IP rating: IP44 lifetime: 10 000 hours 		<p>DCPZ02</p> <p>15 50 005 001</p>  <p>8 592920 094037</p> <ul style="list-style-type: none"> dimensions: 7.35 m area of use: both outdoor and indoor timer: no remote control: no power: 750 W max. IP rating: IP44 	<p>1/-/-/2</p> <p>ZY2294</p>   <ul style="list-style-type: none"> lifetime: 10 000 hours 	

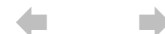
**DCPW04**

1/-/-/6

15 50 005 016

DCPW04



8 592920 099551



- product: garland
- light color: warm white
- dimensions: 7.6 m
- area of use: both outdoor and indoor
- timer: no
- remote control: no

- number of LED: 16
- supply line length: 5 m
- power: 6 W
- IP rating: IP44
- lifetime: 10 000 hours

DCPW07

1/-/-/6

15 50 005 019

DCPW07



8 592920 110829



- product: garland
- light color: warm white
- dimensions: 7.6 m
- area of use: both outdoor and indoor
- timer: no
- remote control: no

- number of LED: 20
- supply line length: 5 m
- power: 6 W
- IP rating: IP44
- lifetime: 10 000 hours

Lantern

DCLV01

1/-/-/15

15 50 001 013

ZY2114



8 592920 093771



- product: lantern
- light color: vintage
- dimensions: 10.5 × 24 cm
- area of use: indoor
- timer
- remote control: no

- number of LED: 1
- power: 0.06 W
- IP rating: IP20
- lifetime: 10 000 hours

DCLV02

1/-/-/15

15 50 001 014

ZY2115



8 592920 093788



- product: lantern
- light color: vintage
- dimensions: 10.5 × 24 cm
- area of use: indoor
- timer
- remote control: no

- number of LED: 1
- power: 0.06 W
- IP rating: IP20
- lifetime: 10 000 hours

LED candles

DCCV06

1/-/-/8

15 50 001 005

ZY2141



8 592920 093696



- product: candle
- light color: vintage
- dimensions: 7.5 × 10/12.5/15 cm
- area of use: indoor
- timer
- remote control: yes (1× CR2032, include)

- number of LED: 3× 1
- power: 0.06 W
- IP rating: IP20
- lifetime: 10 000 hours

DCCV07

1/-/-/8

15 50 001 006

ZY2143



8 592920 093702







- product: candle
- light color: vintage
- dimensions: 7.5 × 10/12.5/15 cm
- area of use: indoor
- timer
- remote control: yes (1× CR2032, include)

- number of LED: 3× 1
- power: 0.06 W
- IP rating: IP20
- lifetime: 10 000 hours







DCCV11 6/-/-216
15 50 001 010 ZY2149





- product: candle
- light color: vintage
- dimensions: 3.8 × 3.8 cm
- area of use: indoor
- timer: no
- remote control: no
- number of LED: 6 × 1
- power: 0.06 W
- IP rating: IP20
- lifetime: 10 000 hours

DCCV12 6/-/-216
15 50 001 011 ZY2150





- product: candle
- light color: vintage
- dimensions: 3.8 × 3.8 cm
- area of use: indoor
- timer: no
- remote control: no
- number of LED: 6 × 1
- power: 0.06 W
- IP rating: IP20
- lifetime: 10 000 hours

DCCV13 6/-/-216
15 50 001 012 ZY2151





- product: candle
- light color: vintage
- dimensions: 3.8 × 3.8 cm
- area of use: indoor
- timer: no
- remote control: no
- number of LED: 6 × 1
- power: 0.06 W
- IP rating: IP20
- lifetime: 10 000 hours

DCCV19 1/-/-35
15 50 000 056 ZY2371T





- product: grave candle
- light color: warm white
- dimensions: 7 × 12.5 cm
- area of use: both outdoor and indoor
- timer: no
- remote control: no
- number of LED: 1
- power: 0.06 W
- IP rating: IP44
- lifetime: 10 000 hours

DCCV20 1/-/-35
15 50 000 057 ZY2372



- product: grave candle
- light color: warm white
- dimensions: 7 × 12.5 cm
- area of use: both outdoor and indoor
- timer: sensor
- remote control: no
- number of LED: 1
- power: 0.06 W
- IP rating: IP44
- lifetime: 10 000 hours

DCCV21 1/-/-24
15 50 001 024 DCCV21

- product: grave candle
- light color: vintage
- dimensions: 7 × 12.5 cm
- area of use: both outdoor and indoor
- timer: no
- remote control: no
- number of LED: 1
- power: 0.06 W
- IP rating: IP44
- lifetime: 10 000 hours

DCCV22 1/-/-24
15 50 001 029 DCCV22

- product: grave candle
- light color: vintage
- dimensions: 7.5 × 25 cm
- area of use: both outdoor and indoor
- timer: no
- remote control: no
- number of LED: 1
- power: 0.06 W
- IP rating: IP44
- lifetime: 1 500 hours

Weather stations, thermometers, scales, others



Weather stations

Weather stations

- can assess current weather and forecast
- display temperature and humidity (in and out), time and date
- wireless comm. with up to 3 sensors (powered by AA or AAA)
- large colour display, LED backlight (perm/temp) & projector
- with stand/for hanging on the wall, battery or mains powered

clock: DCF (radio controlled clock) = LED backlight display = the possibility of hanging on the wall = time zones = date = calendar = alarm clock: yes, 2x = outdoor temperature: -30 °C to +60 °C, resolutions 0.1 °C = indoor temperature: -10 °C to +50 °C, resolution 0.1 °C = outdoor humidity: 1 % až 99 % RV, resolution 1 % = indoor humidity: 1 % to 99 % RH, resolution 1 % = min. and max. temperature = weather forecast = temperature warning = pressure trend = barometer = rain gauge = anemometer = altitude adjustment = moon phase = range of the sensor: up to 100 m = possible additional sensor: up to 3 temperature and humidity sensors (E06018), 1 anemometer sensor (E06016) = power of sensor: 4x 1.5 V AA (not included) = power of station: 3x 1.5 V AAA (not included) = AC adapter: yes, 5 V DC/300 mA (included) = main unit size: 17 × 192 ×



 **E6016** 1/-/-/1
26 06 164 000 E6016

clock: DCF (radio controlled clock) = color backlight display (Black Mask) = date = calendar = alarm clock: yes, 2x = outdoor temperature: -20 °C to +60 °C, resolution 0.1 °C = indoor temperature: -5 °C to +50 °C, resolution 0.1 °C = min. and max. temperature = weather forecast = rain gauge: no = anemometer: no = range of the sensor: up to 30 m = possible additional sensor: 3 (E08400) = power of sensor: 2x 1.5 V AA (not included) = power of station: 1x CR2032 (included) = AC adapter: yes, 4.5 V DC/300 mA (included) = main unit size: 56 × 163 × 80 mm



 **E8466** 1/-/-/8
26 06 150 000 E8466



www.emos.eu

Order Code
Item Number

Packaging
Type

clock: DCF (radio controlled clock) = LED backlight display = the possibility of hanging on the wall = color backlight display (Black Mask) = time zones = date = calendar = alarm clock: yes, 2x = outdoor temperature: -40 °C to +70 °C, resolution 0.1 °C = indoor temperature: -10 °C to +50 °C, resolution 0.1 °C = outdoor humidity: 20 % to 95 % RH, resolution 1 % = indoor humidity: 1 % to 99 % RH, resolution 1 % = min. and max. temperature = weather forecast = pressure trend = barometer = rain gauge: no = anemometer: no = moon phase = range of the sensor: up to 50 m = possible additional sensor: 3 (E05018) = wired probe for sensor: 0.95 m = power of sensor: 2x 1.5 V AAA (not included) = power of station: 3x 1.5 V AAA (not included) = AC adapter: yes, 5 V DC/600 mA (included) = main unit size: 26 × 197 × 125 mm



E5111
26 06 170 000

1/-/-8
E5111



clock: DCF (radio controlled clock) = LED backlight display = the possibility of hanging on the wall = color backlight display (Black Mask) = time zones = date = calendar = alarm clock: yes, 2x = outdoor temperature: -50 °C to +70 °C, resolution 0.1 °C = indoor temperature: -10 °C to +50 °C, resolution 0.1 °C = outdoor humidity: 1 % až 99 % RV, resolution 1 % = indoor humidity: 1 % to 99 % RH, resolution 1 % = min. and max. temperature = weather forecast = temperature warning = pressure trend = barometer = rain gauge: no = anemometer: no = altitude adjustment = moon phase = range of the sensor: up to 100 m = possible additional sensor: 3 (E06018) = power of sensor: 2x 1.5 V AAA (not included) = power of station: 3x 1.5 V AAA (not included) = AC adapter: yes, 5 V DC/300 mA (included) = main unit size: 17 × 192 × 127 mm



E6018
26 06 162 000

1/-/-12
E6018



clock: DCF (radio controlled clock) = LED backlight display = the possibility of hanging on the wall = time zones = date = calendar = alarm clock: yes, 2x = outdoor temperature: -40 °C to +70 °C, resolution 0.1 °C = indoor temperature: -10 °C to +50 °C, resolution 0.1 °C = outdoor humidity: 20 % to 95 % RH, resolution 1 % = indoor humidity: 1 % to 99 % RH, resolution 1 % = min. and max. temperature = weather forecast = pressure trend = barometer = rain gauge: no = anemometer: no = altitude adjustment = range of the sensor: up to 30 m = possible additional sensor: 3 (E05018) = wired probe for sensor = power of sensor: 2x 1.5 V AAA (not included) = power of station: 3x 1.5 V AA (not included) = main unit size: 27 × 130 × 130 mm



E5080
26 06 169 000

1/-/-12
E5080



clock: DCF (radio controlled clock) = LED backlight display = time zones = date = calendar = alarm clock = outdoor temperature: -50 °C to +70 °C, resolution 0.1 °C = indoor temperature: -10 °C to +50 °C, resolution 0.1 °C = outdoor humidity: 20 % to 95 %, resolution 1 % = indoor humidity: 20 % to 95 %, resolution 1 % = min. and max. temperature = weather forecast = temperature warning = rain gauge: no = anemometer: no = moon phase = range of the sensor: up to 30 m = possible additional sensor: 3 (E05018) = power of sensor: 2x 1.5 V AAA (not included) = power of station: 2x 1.5 V AA (not included) = main unit size: 50 × 120 × 180 mm



E3003
26 06 153 000

1/-/-10
E3003



clock: DCF (radio controlled clock) = LED backlight display = time zones = date = calendar = alarm clock = outdoor temperature: -30 °C to +60 °C, resolutions 0.1 °C = indoor temperature: 0 °C to +50 °C, resolution 0.1 °C = indoor humidity: 20 % to 90 % RH, resolution 1 % = weather forecast = rain gauge: no = anemometer: no = moon phase = range of the sensor: up to 30 m = possible additional sensor: 3 (E03070) = power of sensor: 2x 1.5 V AAA (not included) = power of station: 3x 1.5 V AAA (not included) = main unit size: 52 × 139 × 100 mm



E3070
26 06 139 000

1/-/-18
E3070





www.emos.eu

Order Code
Item Number

Packaging
Type

clock: DCF (radio controlled clock) = the possibility of hanging on the wall = time zones = date = calendar = alarm clock = outdoor temperature: -40 °C to +60 °C, resolution 0.1 °C = indoor temperature: -10 °C to +50 °C, resolution 0.1 °C = outdoor humidity: 20 % to 95 % RH, resolution 1 % = indoor humidity: 1 % to 99 % RH, resolution 1 % = min. and max. temperature = weather forecast = rain gauge: no = anemometer: no = moon phase = range of the sensor: up to 30 m = possible additional sensor: 3 (E05018) = power of sensor: 2× 1.5 V AA (not included) = power of station: 2× 1.5 V AAA (not included) = main unit size: 23 × 76 × 126 mm



E0352 1/-/-/20
26 06 166 000 E0352

clock: yes, quartz = date = calendar = alarm clock = outdoor temperature: -50 °C to +70 °C, resolution 0.1 °C = indoor temperature: -10 °C to +50 °C, resolution 0.1 °C = indoor humidity: 20 % to 95 % RH, resolution 1 % = min. and max. temperature = weather forecast = rain gauge: no = anemometer: no = moon phase = wired probe for sensor: 1.9 m = power of station: 2× LR1130 (included) = main unit size: 16 × 70 × 109 mm



E0117N 1/-/-/80
26 06 003 000 E0117N

clock: yes, quartz = LED backlight display = the possibility of hanging on the wall = color backlight display (Black Mask) = alarm clock = outdoor temperature: -50 °C to +70 °C, resolution 0.1 °C = indoor temperature: -10 °C to +50 °C, resolution 0.1 °C = outdoor humidity: 20 % to 95 % RH, resolution 1 % = indoor humidity: 20 % to 95 % RH, resolution 1 % = min. and max. temperature = weather forecast = rain gauge: no = anemometer: no = range of the sensor: up to 50 m = power of sensor: 2× 1.5 V AAA (not included) = power of station: 2× 1.5 V AAA (not included) = AC adapter: yes, micro USB 5 V/1 A (not included) = main unit size: 20 × 85 × 96 mm



E8647 1/-/-/20
26 06 172 000 E8647

clock: DCF (radio controlled clock) = LED backlight display = the possibility of hanging on the wall = color backlight display (Black Mask) = time zones = date = calendar = alarm clock = outdoor temperature: -30 °C to +60 °C, resolutions 0.1 °C = indoor temperature: -10 °C to +50 °C, resolution 0.1 °C = outdoor humidity: 10 % to 99 % RH, resolution 1 % = indoor humidity: 10 % to 99 % RH, resolution 1 % = min. and max. temperature = weather forecast = temperature warning = barometer = rain gauge = anemometer: no = range of the sensor: up to 50 m = power of sensor: 2× 1.5 V AA (not included) = power of station: 3× 1.5 V AAA (not included) = AC adapter: yes, 5 V DC/1 000 mA (included) = main unit size: 29 × 205 × 127 mm



E8670 1/-/-/6
26 06 174 000 E8670

clock: DCF (radio controlled clock) = LED backlight display = the possibility of hanging on the wall = color backlight display (Black Mask) = time zones = date = calendar = alarm clock = outdoor temperature: -40 °C to +60 °C, resolution 0.1 °C = indoor temperature: -10 °C to +50 °C, resolution 0.1 °C = outdoor humidity: 1 % až 99 % RV, resolution 1 % = indoor humidity: 1 % to 99 % RH, resolution 1 % = min. and max. temperature = weather forecast = temperature warning = pressure trend = barometer = rain gauge: no = anemometer: no = moon phase = range of the sensor: up to 80 m = possible additional sensor: 3 (E00387) = power of sensor: 2× 1.5 V AA (not included) = power of station: 3× 1.5 V AA (not included) = AC adapter: yes, 5 V DC/1 200 mA (included) = main unit size: 30 × 200 × 130 mm



E0387 1/-/-/8
26 06 176 000 E0387



www.emos.eu

Order Code
Item Number

Packaging
Type

clock: DCF (radio controlled clock) = LED backlight display = color backlight display (Black Mask) = time zones = date = calendar = alarm clock = outdoor temperature: -50 °C to +70 °C, resolution 0.1 °C = indoor temperature: -2 °C to +50 °C, resolution 0.1 °C = outdoor humidity: 20 % to 95 % RH, resolution 1 % = indoor humidity: 20 % to 95 % RH, resolution 1 % = min. and max. temperature = weather forecast = temperature warning = pressure trend = barometer = rain gauge: no = anemometer: no = moon phase = range of the sensor: up to 100 m = possible additional sensor: 3 (E00387, E05018) = power of sensor: 2× 1.5 V AAA (not included) = power of station: 2× 1.5 V AA (not included) = AC adapter: yes, USB-C 9 V DC/2 000 mA, 1.5 m (included) = main unit size: 133 × 125 × 110 mm



E8010
26 06 179 000

1/-/-/6
E8010

Thermometers

Thermometers

- displays indoor & outdoor temperature, some also humidity
- wireless or with probe (wire-connected, out the window)
- measures indoor humidity via integrated sensor in the body
- selected models also feature calendar, alarm and ice warning
- hung on wall or window, thermometer & probe battery-powered

thermometer design: wireless = clock: DCF (radio controlled clock) = LED backlight display = time zones = indoor temperature: -9 °C to +50 °C, resolution 0.1 °C = outdoor temperature: -50 °C to +70 °C, resolution 0.1 °C = min. and max. temperature = range in open space: up to 60 m = possible additional sensor: 1 (E05018) = the possibility of hanging on the wall = power of station: 2× 1.5 V AAA (not included) = power of sensor: 2× 1.5 V AAA (not included) = main unit size: 25 × 82 × 152 mm = sensor size: 27 × 60 × 95 mm = screen size: 54 × 74 mm



E0107
26 03 115 000

1/-/-/24
E0107T

thermometer design: wireless = indoor temperature: -10 °C to +50 °C, resolution 0.1 °C = outdoor temperature: -30 °C to +50 °C, resolutions 0.1 °C = min. and max. temperature = range in open space: up to 80 m = possible additional sensor: 1 (E05018) = the possibility of hanging on the wall = power of station: 2× 1.5 V AAA (not included) = power of sensor: 2× 1.5 V AAA (not included) = main unit size: 91,8 × 20 × 91,8 mm = sensor size: 31 × 19 × 100 mm = screen size: Ø 64 mm



E0129
26 03 119 002

1/-/-/20
E0129

thermometer design: wireless = indoor temperature: 0 °C to +60 °C, resolution 0.1 °C = outdoor temperature: -40 °C to +60 °C, resolution 0.1 °C = range in open space: up to 100 m = the possibility of hanging on the wall = power of station: 2× 1.5 V AAA (not included) = power of sensor: 2× 1.5 V AAA (not included) = main unit size: 18 × 56 × 85 mm = sensor size: 20 × 49 × 68 mm = screen size: 34 × 39 mm



E0042 1/-/-/30
26 03 118 000 E0042

thermometer design: wireless = clock: DCF (radio controlled clock) = LED backlight display = time zones = date = alarm clock = snooze = indoor temperature: 0 °C to +50 °C, resolution 0.1 °C = outdoor temperature: -20 °C to +60 °C, resolutions 0.1 °C = min. and max. temperature = range in open space: up to 30 m = possible additional sensor: 1 (E05018) = power of station: 2× 1.5 V AAA (not included) = power of sensor: 2× 1.5 V AAA (not included) = main unit size: 30 × 78 × 78 mm = sensor size: 25 × 60 × 95 mm = screen size: 46 × 49 mm



E0127 1/-/-/18
26 03 121 000 E0127

thermometer design: wire = indoor temperature: -10 °C to +50 °C, resolution 1 °C = indoor humidity: 20 % to 99 % RH, resolution 1 % = outdoor temperature: -50 °C to +70 °C, resolution 1 °C = min. and max. temperature = temperature warning = temperature index = wired probe for sensor: 2 m = the possibility of hanging on the wall = power of station: 2× 1.5 V AAA (not included) = main unit size: 22 × 106 × 117 mm = screen size: 64 × 76 mm



E8471 1/-/-/40
26 03 014 000 RS8471

thermometer design: wire = indoor temperature: 0 °C to +60 °C, resolution 0.1 °C = outdoor temperature: -40 °C to +60 °C, resolution 0.1 °C = wired probe for sensor: 2 m, Ø 8 mm = the possibility of hanging on the wall = power of station: 2× 1.5 V AAA (not included) = main unit size: 18 × 57 × 85 mm = screen size: 34 × 40 mm



E0041 1/-/-/30
26 03 013 000 E0041

thermometer design: wireless = clock: yes, quartz = LED backlight display = date = alarm clock = snooze = indoor temperature: 0 °C to +50 °C, resolution 0.1 °C = indoor humidity: 20 % to 90 % RH, resolution 1 % = min. and max. temperature = power of station: 1× 1.5 V AA (not included) = main unit size: 37 × 93 × 93 mm = screen size: 60 × 65 mm



E0114 1/5/-/50
26 03 117 000 E0114



www.emos.eu

Order Code
Item Number

Packaging
Type

thermometer design: wire = clock = alarm clock = snooze = indoor temperature: 0 °C to +50 °C, resolution 0.1 °C = indoor humidity: 25 % to 95 % RH, resolution 1 % = outdoor temperature: -40 °C to +60 °C, resolution 0.1 °C = min. and max. temperature = wired probe for sensor: 2,9 m, Ø 4 mm = the possibility of hanging on the wall = power of station: 1× 1.5 V AAA (not included) = main unit size: 23 × 76 × 107 mm = screen size: 46 × 61 mm



E0121
26 03 016 001

1/-/-/20
E0121



thermometer design: wire = indoor temperature: 0 °C to +60 °C, resolution 0.1 °C = outdoor temperature: -40 °C to +60 °C, resolution 0.1 °C = min. and max. temperature = wired probe for sensor: 0.9 m = the possibility of hanging on the wall = power of station: 2× 1.5 V AAA (not included) = main unit size: 19 × 58 × 75 mm = screen size: 41 × 52 mm



E0422
26 03 016 002

1/-/-/30
E0422



thermometer design: wireless = clock: yes, quartz = LED backlight display = alarm clock = snooze = indoor temperature: 0 °C to +50 °C, resolution 0.1 °C = outdoor temperature: -30 °C to +60 °C, resolutions 0.1 °C = min. and max. temperature = range in open space: up to 50 m = possible additional sensor: 3 (E05018) = the possibility of hanging on the wall = power of station: 2× 1.5 V AAA (not included) = power of sensor: 2× 1.5 V AAA (not included) = main unit size: 21 × 80 × 110 mm = sensor size: 25 × 50 × 95 mm = screen size: 53 × 81 mm



E8636
26 03 119 003

1/-/-/32
E8636



thermometer design: wireless = magnet for fixing = indoor temperature: -10 °C to +50 °C, resolution 0.1 °C = indoor humidity: 20 % to 90 % RH, resolution 1 % = the possibility of hanging on the wall = power of station: 1× 3 V CR2032 (included) = main unit size: 46 × 16 × 62 mm = screen size: 34 × 41 mm



E0345
26 03 203 000

1/-/50/100
ET345TH



Thermometers GoSmart



- For measuring indoor temperature and humidity
- Display temperature and humidity data history in the app
- Temperature and humidity alerts via alarm
- Small size and elegant design
- Battery powered
- Connection to home network via ZigBee protocol
- Compatibility with EMOS GoSmart products and TUYA devices
- Voice control with Google Assistant and Amazon Alexa



thermometer design: wireless – smart = indoor temperature: -20 °C to +60 °C, resolution 0.1 °C = indoor humidity: 0 % to 99 % RH, resolution 1 % = temperature warning = the possibility of hanging on the wall = power of station: 1× 3 V CR2032 (included) = main unit size: 26 × 13 × 52 mm



EGS0102

1/-/-/80

26 03 122 000

EGS0102



thermometer design: wireless – smart = clock: wifi = LED backlight display = date = indoor temperature: -10 °C to +60 °C, resolution 0.1 °C = indoor humidity: 0 % to 99 % RH, resolution 1 % = min. and max. temperature = temperature warning = the possibility of hanging on the wall = power of station: 3× 1.5 V AAA (not included) = main unit size: 56 × 23 × 56 mm = screen size: 42 × 40 mm



EGS0101

1/-/-/80

26 03 123 000

EGS0101



Spare sensors

- wireless sensors and wired probes for EMOS weather stations
- measure outdoor temperature and humidity (-50 to +70 °C)
- range of up to 25–100 m in an open area

designed for the type of main unit: AOK-5018B, AOK-5060, S627BS, IB303TR, E0107T, IW001-DCF, IW003-DCF, E5068, E5062, E5063, E3078, E3028, E0300, E8236, E0211, E3010, E0127, E0329, E5005, E3003, E0107, E0129, E5101, E5010, E0352, E5059, E5111, E8636, E0316 = indicator of outdoor humidity: 20 % to 95 % RH, resolution 1 % = range in open space: up to 25 m = external wire sensor = operating temperature: -50 °C to +70 °C, resolution 0.1 °C = power source: 2× 1.5 V AAA (not included) = dimensions: 21 × 60 × 100 mm



E05018

1/-/-/100

26 93 000 120

AOK2011



designed for the type of main unit: E3070 = range in open space: up to 30 m = operating temperature: -30 °C to +60 °C, resolution 0.1 °C = power source: 2× 1.5 V AAA (not included) = dimensions: 84 × 64 × 25 mm



E03070 1/-/-/100
26 93 000 180 E03070

designed for the type of main unit: C8403D, C8404C, C8405D, E8468, E8466 = indicator of outdoor humidity: 20 % to 90 % RH, resolution 1 % = range in open space: up to 50 m = operating temperature: -40 °C to +70 °C, resolution 0.1 °C = power source: 2× 1.5 V AA (not included) = dimensions: 64 × 100 × 35 mm



E08400 1/-/-/50
26 93 000 160 C8340C

designed for the type of main unit: E6018, E6016 = indicator of outdoor humidity: 1 % to 99 % RH, resolution 1 % = range in open space: up to 100 m = operating temperature: -50 °C to +70 °C, resolution 0.1 °C = power source: 2× 1.5 V AAA (not included) = dimensions: 15 × 62 × 100 mm



E60018 1/-/-/100
26 93 000 220 E06018

designed for the type of main unit: E6016 = indicator of outdoor humidity: 1 % to 99 % RH, resolution 1 % = range in open space: up to 100 m = operating temperature: -30 °C to +60 °C, resolution 0.1 °C = power source: 4× 1.5 V AA (not included) = dimensions: 275 × 135 × 310 mm



E60016 1/-/-/1
26 93 000 230 E06016

designed for the type of main unit: E0387 = indicator of outdoor humidity: 1 % to 99 % RH, resolution 1 % = range in open space: up to 80 m = operating temperature: -40 °C to +60 °C, resolution 0.1 °C = power source: 2× 1.5 V AA (not included) = dimensions: 20 × 38 × 100 mm



E00387 1/-/-/100
26 93 000 240 E00387

Kitchen, hanging scales

- digital kitchen scales with load capacity of up to 5–15 kg
- ability to switch between units (g, kg, ml, lb, oz)
- with and without backlit screen
- powered by AAA or button batteries (CR2032)
- battery-free scales – turning wheel charges up for 2 minutes
- ABS plastic, toughened glass or stainless surface
- with tare and overload function
- digital hanging scales, 50 kg capacity (for fish or luggage)

- scale surface: tempered glass
- tare function
- maximum load: 5 kg
- weight units: g, oz, lb, kg
- power source: 1× 3 V CR2032 (included)
- dimensions: 15 × 152 × 219 mm

**EV014**

1/-/-/20

26 17 001 400

TY3101

- scale surface: tempered glass
- tare function
- maximum load: 5 kg
- weight units: g, oz, lb, kg
- power source: 1× 3 V CR2032 (included)
- dimensions: 15 × 152 × 219 mm

**EV014B**

1/-/-/20

26 17 001 401

TY3101B

- backlight display
- scale surface: ABS plastic
- tare function
- maximum load: 5 kg
- weight units: g, oz, lb, kg, ml
- power source: 2× 1.5 V AAA (not included)
- dimensions: 20 × 198 × 223 mm

**EV025**

1/-/-/6

26 17 002 500

EV025

- backlight display
- scale surface: ABS plastic
- tare function
- maximum load: 5 kg
- weight units: g, kg, lb, oz
- power source: 2× 1.5 V AAA (not included)
- dimensions: 49 × 150 × 218 mm

**EV016**

1/-/-/6

26 17 001 600

GP-KS021

- backlight display
- scale surface: tempered glass
- tare function
- maximum load: 15 kg
- weight units: g, kg, lb, oz
- power source: 2× 1.5 V AAA (included)
- dimensions: 22 × 180 × 210 mm



EV022
26 17 002 200

1/-/-/12
EV022

- backlight display
- scale surface: stainless steel
- tare function
- maximum load: 5 kg
- weight units: g, oz, lb, kg
- power source: 2× 3 V CR2032 (included)
- dimensions: 15 × 163 × 221 mm



EV012
26 17 001 200

1/-/-/12
PT-836

- backlight display
- scale surface: stainless steel
- tare function
- maximum load: 15 kg
- weight units: g, kg, lb, oz
- power source: 2× 1.5 V AAA (not included)
- dimensions: 15 × 176 × 216 mm



EV023
26 17 002 300

1/-/-/20
EV023

- backlight display
- scale surface: stainless steel
- tare function
- maximum load: 10 kg
- weight units: g, kg, ml, oz, lb, tl
- power source: 2× 1.5 V AAA (included)
- dimensions: 15 × 153 × 212 mm



EV026
26 17 000 500

1/-/-/20
EV026

- scale surface: ABS plastic + aluminium (Al)
- tare function
- maximum load: 50 kg
- weight units: kg, lb
- power source: 1× 3 V CR2032 (included)
- dimensions: 31 × 40 × 148 mm



EV020
26 17 002 000

1/-/-/40
EV020

- backlight display
- scale surface: ABS plastic + stainless steel
- tare function
- maximum load: 3 kg
- weight units: g, lb, oz
- power source: 3× 1.5 V AAA (included)
- dimensions: 154 × 28 × 190 mm



EV029
26 17 002 600

1/-/-/10
EV029

- scale surface: ABS plastic
- tare function
- maximum load: 5 kg
- weight units: g, oz, lb:oz, ml, fl:oz
- power source: 1× 3 V CR2032 (included)
- dimensions: 15 × 176 × 216 mm



EV028
26 17 002 800

1/-/-/40
EV028

Kitchen timers

- serves as a timer (countdown) and stopwatch (counts from 0)
- triggers audio alert once time limit expires
- selected models even allow 2 counts at the same time
- fitted with magnet for mounting on a fridge/adjustable stand
- draws power from AAA or button battery

- countdown of time max. from: 99 min. 59 sec.
- stopwatch
- memory of the last value
- magnet for fixing
- power source: 1× 1.5 V LR1130 (included)
- dimensions: 7 × 55 × 70 mm
- packaging: 1 pc, blister



E0202
26 05 004 000

1/-/10/100
TP202

- thermometer design: wire
- stopwatch
- magnet for fixing
- countdown of time max. from: 99 min. 59 sec.
- memory of the last value
- outdoor temperature: -20 °C to +250 °C, res. 1 °C
- temperature warning
- wired probe for sensor: 1.4 m
- the possibility of hanging on the wall
- power of station: 1× 1.5 V AAA (not included)
- main unit size: 18 × 65 × 70 mm
- screen size: 47 × 21 mm



E2157
26 03 015 000

1/-/10/40
E2157

Personal scales

- modern look complements a bathroom and helps you keep fit
- ensures healthy weight loss by measuring fat, water & muscle
- memory for 10–13 people (stores height, weight, age and sex)
- draws power from AAA or button batteries (CR2032)
- toughened glass can carry 150–180 kg (depending on model)

- backlight display
- scale surface: tempered glass
- maximum load: 150 kg
- BMI – measurement of fat, water and muscle
- weight units: kg, lb, St
- memory: 10 persons max.
- power source: 2× 1.5 V AAA (included)
- dimensions: 20 × 330 × 320 mm

**EV104**

1/-/-/6

26 17 010 400

PT-718

- backlight display
- scale surface: tempered glass
- maximum load: 180 kg
- weight units: kg, lb, St
- power source: 2× 1.5 V AAA (included)
- dimensions: 25 × 280 × 280 mm

**EV106**

1/-/-/5

26 17 010 600

EV106

- scale surface: tempered glass
- maximum load: 180 kg
- weight units: kg, lb, St
- power source: 1× 3 V CR2032 (included)
- dimensions: 20 × 300 × 300 mm

**EV105**

1/-/-/6

26 17 010 500

TY6108

Air quality GoSmart



- Overview of the CO2 level in the monitored room
- Display of indoor temperature, humidity and hours
- LED display with permanent backlight
- Colour animation of air quality
- Built-in alarm for elevated CO2 concentration
- Connection to home network via WIFI protocol
- Compatibility with EMOS GoSmart products and TUYA devices



- option to set the temperature unit: °C/°F
- CO2 alert
- setting CO2 alert limits
- CO2 level indicator
- CO2 measurement range: 400 to 5 000 PPM
- indoor temperature: 0 °C to +50 °C, resolution 0.1°C
- indoor humidity: 20 % to 90 % RH, resolution 1 %
- supported OS: Android, iOS
- compatibility: EMOS GoSmart, TUYA, LIDL, Smartlife
- protocol: Wi-Fi
- transmission frequency: 2.4 GHz Wi-Fi
- notifications to the mobile app
- application languages: EN, CZ, SK, PL, DE, HU, SI, FR,



E30300 1/-/-/12
26 27 303 000 E30300

Bathroom scales GoSmart



- Wide range of measuring indicators
- Clear reports in graphical form
- Memory for several users
- Elegant design
- Weighing accuracy to 100 g, max. load capacity 180 kg
- Connection to home network via Bluetooth
- Compatibility with EMOS GoSmart products and TUYA devices

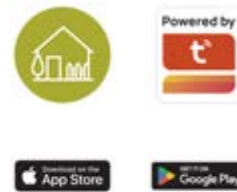

- backlight display
- scale surface: ITO tempered glass
- maximum load: 180 kg
- Bluetooth
- BMI – measurement of fat, water and muscle
- weight units: kg, lb
- memory: 10 persons max.
- power source: 3× 1.5 V AAA (included)
- dimensions: 26 × 300 × 300 mm
- supported OS: Android, iOS
- compatibility: EMOS GoSmart, TUYA, LIDL, Smartlife,
- protocol: Wi-Fi
- transmission frequency: 2.4 GHz Wi-Fi
- notifications to the mobile app
- application languages: EN, CZ, SK, PL, DE, HU, SI, FR,



EV112 1/-/-/3
26 17 010 902 EV112

TV and audio accessories



Multimedia players, radios

- wirelessly connects to Bluetooth devices (phone, tablet...)
- crystal clear sound, long battery run time and USB charging
- selected models also have a micro SD card slot or radio port
- can be used as handsfree (in car, kitchen) due to microphone
- also, portable FM radios with slot for SD card and USB

tuner frequency: FM 88-108 MHz = USB input = slot for microSD card = MP3 support = headphone output = power supply: 5 V/USB-C (not included) = antenna: telescopic antenna = speaker: 50 mm/4 Ohm/3 W = dimensions: 125 × 30 × 70 mm = packaging: 1 pc, box



E0086

1/-/-/32

26 18 002 600

EM-213

TV wall mounts

- fixed, tilting and bracket mounts for TVs of various sizes
- meet strictest rigidity, load and variability requirements
- in various sizes, load capacity up to 95 kg
- installation material for standard wall types included

holder type: tilting = acceptable screen diagonals: 32-90" (81-229 cm) = min. VESA mounting dimensions: 200 × 200 mm = max. VESA mounting dimensions: 600 × 400 mm = tilt: -10° = distance from a wall: 37 mm = max. load capacity (kg): 60 = dimensions: 20 × 650 × 140 mm = packaging: 1 pc, paper box



KT2265

1/-/-/6

32 32 226 500

BETA 600X

holder type: tilting = acceptable screen diagonals: 29–65" (74–165 cm) = min. VESA mounting dimensions: 200 × 200 mm = max. VESA mounting dimensions: 400 × 400 mm = tilt: -10° = distance from a wall: 25 mm = max. load capacity (kg): 50 = dimensions: 20 × 470 × 220 mm = packaging: 1 pc, paper box



KT2244
32 32 224 400

1/-/-5
BETA 400

holder type: console = acceptable screen diagonals: 32–80" (81–203 cm) = min. VESA mounting dimensions: 200 × 200 mm = max. VESA mounting dimensions: 600 × 400 mm = tilt: +/-15° = positioning: +/- 90° = distance from a wall: 76–510 mm = max. load capacity (kg): 60 = dimensions: 510 × 650 × 204 mm = packaging: 1 pc, paper box



KT3564
32 32 356 400

1/-/-2
GAMMA 600
ULTRA X

holder type: console = acceptable screen diagonals: 32–80" (81–203 cm) = min. VESA mounting dimensions: 200 × 200 mm = max. VESA mounting dimensions: 600 × 400 mm = tilt: -15° = positioning: 180° = distance from a wall: 59–635 mm = max. load capacity (kg): 50 = dimensions: 630 × 80 × 300 mm = packaging: 1 pc, paper box



KT3364
32 32 336 400

1/-/-2
GAMMA LED 600

holder type: console = acceptable screen diagonals: 10–39" (25–99 cm) = min. VESA mounting dimensions: 75 × 75 mm = max. VESA mounting dimensions: 200 × 200 mm = tilt: 10°/-15° = positioning: 180° = distance from a wall: 102–340 mm = max. load capacity (kg): 30 = dimensions: 355 × 90 × 180 mm = packaging: 1 pc, paper box

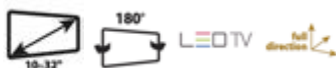

KT3223
32 32 322 300

1/-/-8
GAMMA 200
ULTRA X

Universal remote controllers OFA

- 100 % guaranteed compatibility with your devices
- controller pairs with most devices due to vast code database
- quality material manufacturing
- service support: +420 581 261 101/e-mail: oneforall@emos.cz

possible number of controlled devices: 3 = designed for: TV, DVB-T, SAT, KAB TV, IPTV, Amplifier, Tuner, Home cinema, Sound Bar = code search: manual = simple set settings = learning function = code remembered after removing the battery = range: 15 m = power source: 2× AAA = model line: Zapper = dimensions: 20 × 48 × 174 mm = weight: 80 g = packaging: 1 pc, blister



8 716184 059933

KE6820

32 33 068 200

1/-/3/24

URC6820

possible number of controlled devices: 8 = designed for: TV, DVB-T, SAT, KAB TV, IPTV, DVD, Blu-ray, Video, Amplifier, Tuner, Home cinema, CD, iPod Dock = code search: manual = code remembered after removing the battery = range: 15 m = power source: 2× AAA = model line: Basic = dimensions: 24 × 50 × 182 mm = weight: 80 g = packaging: 1 pc, blister



8 716184 045080

KE2981

32 33 029 810

1/-/6/48

URC2981

possible number of controlled devices: 8 = designed for: TV, DVB-T, SAT, KAB TV, IPTV, DVD, Blu-ray, Video, Amplifier, Tuner, Home cinema, CD, iPod Dock = code search: manual = learning function = code remembered after removing the battery = range: 15 m = power source: 2× AAA = model line: Contour = dimensions: 22.3 × 4.4 × 2.0 cm = weight: 84 g = packaging: 1 pc, blister



8 716184 065040

KE1280

32 33 012 800

1/-/6/48

URC1280

possible number of controlled devices: 4 = designed for: TV, DVB-T, SAT, KAB TV, IPTV, DVD, Blu-ray, Video = code search: manual = learning function = code remembered after removing the battery = range: 15 m = power source: 2× AAA = model line: Contour = dimensions: 22.3 × 4.4 × 2.0 cm = weight: 84 g = packaging: 1 pc, blister



8 716184 065019

KE1240

32 33 012 400

1/-/6/48

URC1240

possible number of controlled devices: 1 = designed for: TV = code search: manual = learning function = code remembered after removing the battery = range: 15 m = power source: 2× AAA = model line: Contour = dimensions: 22.3 × 4.4 × 2.0 cm = weight: 84 g = packaging: 1 pc, blister



KE1210

1/-/6/48

32 33 012 100

URC1210

possible number of controlled devices: 1 = designed for: TV Hisense = code search: readjustment of the code for a particular HISENSE line = learning function = code remembered after removing the battery = range: 15 m = power source: 2× AAA = model line: special TV = dimensions: 24 × 51 × 205 mm = weight: 90 g = packaging: 1 pc, small paper box



KE1916

1/-/3/24

32 33 019 160

KE1916

possible number of controlled devices: 2 = designed for: Samsung TV and audio device = code search: readjustment of the code for a particular SAMSUNG line = simple set settings: yes – for audio device = learning function = code remembered after removing the battery = range: 15 m = power source: 2× AAA = macro device mode re-assignment = model line: special TV = dimensions: 23 × 44 × 195 mm = weight: 90 g = packaging: 1 pc, small paper box



KE4910

1/-/3/24

32 33 049 100

URC 4910

possible number of controlled devices: 2 = designed for: TV LG and audio device = code search: readjustment of the code for a particular LG line = simple set settings: yes – for audio device = learning function = code remembered after removing the battery = range: 15 m = power source: 2× AAA = macro device mode re-assignment = model line: special TV = dimensions: 25 × 44 × 195 mm = weight: 90 g = packaging: 1 pc, small paper box



KE4911

1/-/3/24

32 33 049 110

URC 4911

possible number of controlled devices: 2 = designed for: Sony TV and audio device = code search: readjustment of the code for a particular SONY line = simple set settings: yes – for audio device = learning function = code remembered after removing the battery = range: 15 m = power source: 2× AA = macro device mode re-assignment = model line: special TV = dimensions: 28 × 47 × 224 mm = weight: 88 g = packaging: 1 pc, small paper box



KE4912

1/-/3/24

32 33 049 120

URC 4912



www.emos.eu

Order Code
Item Number

Packaging
Type

possible number of controlled devices: 2 = designed for: Philips TV and audio device = code search: readjustment of the code for a particular Philips line = simple set settings: yes – for audio device = learning function = code remembered after removing the battery = range: 15 m = power source: 2× AAA = macro device mode re-assignment = model line: special TV = dimensions: 22 × 47 × 207 mm = weight: 90 g = packaging: 1 pc, small paper box



8 716184 072727

KE4913

32 33 049 130

1/-/3/24

URC 4913

possible number of controlled devices: 2 = designed for: Panasonic TV and audio device = code search: readjustment of the code for a particular PANASONIC line = simple set settings: yes – for audio device = learning function = code remembered after removing the battery = range: 15 m = power source: 2× AA = macro device mode re-assignment = model line: special TV = dimensions: 28 × 47 × 224 mm = weight: 90 g = packaging: 1 pc, small paper box



8 716184 072758

KE4914

32 33 049 140

1/-/3/24

URC 4914

possible number of controlled devices: 5 = designed for: TV, DVB-T, SAT, KAB TV, IPTV, DVD, Blu-ray, Amplifier, Tuner, Home Cinema, CD, iPod Dock = code search: automatic = simple set settings = learning function = code remembered after removing the battery = range: 15 m = power source: 4× AAA = macro device mode re-assignment = model line: Smart Control 5 = dimensions: 22.2 × 4.3 × 1.8 cm = weight: 100 g = packaging: 1 pc, small paper box



8 716184 073113

KE7955N

32 33 079 551

1/-/3/12

KE7955N

Power supply extension cords, cable reels, plugs, accessories







Power supply extension cords and sockets

FRENCH

Single socket extension cords

Two-cores PVC

- extension cable with one socket
- length: 3 or 20 m, PVC insulation – ideal for the interior
- conductor: 0.75 mm² or 1 mm², child socket covers

P01303	1/-/10/30	
19 02 010 300	P01303	
 8 592920 064504	 	
<ul style="list-style-type: none"> ▪ length: 3 m ▪ number of sockets: 1 ▪ maximum load: 575 W ▪ conductor cross section: 0.75 mm² ▪ conductor: H03VVH2-F ▪ type of insulation: PVC 	<ul style="list-style-type: none"> ▪ children protection ▪ packaging: 1 pc, hanging 	

P01320R	1/-/-/4	
19 01 012 016	P01320R, P01320RH	
 8 592920 119297	 	
<ul style="list-style-type: none"> ▪ length: 20 m ▪ conductor cross section: 1.5 mm² ▪ voltage: 230 V ▪ current: 16 A ▪ IP rating: IP20 ▪ number of sockets: 1 	<ul style="list-style-type: none"> ▪ thermal fuse: no ▪ conductor: H05VV-F2 ▪ max. unreeled load: 16 A max./3 680 W ▪ children protection ▪ packaging: 1 pc, shrink 	





Power supply extension cords and sockets





SCHUKO





MOES Extension cords

1-phase 16A with rubber insulation

- neoprene extension cord – resists water (IP44) and heat
- conductor: 1.5 mm², length 3–10 m, max. load: 3 680 W
- backlit switch with rubber cover
- 4 round sockets, child socket covers
- openings in socket panel body for mounting onto a wall etc.





P14231	1/-/-/10	
19 22 140 302	E-K-4E	
		
<ul style="list-style-type: none"> ▪ length: 3 m ▪ number of sockets: 4× 2P + PE SCHUKO ▪ voltage/current: 250 V~/16 A max. ▪ maximum load: 3 680 W ▪ type of insulation: rubber/neopren ▪ conductor: H07RN-F3G 1.5 mm² ▪ material of the sockets + plugs: plastic / ▪ packaging: 1 pc, foil 		

P14251	1/-/-/6	
19 22 340 501	E-K-4E	
		
<ul style="list-style-type: none"> ▪ length: 5 m ▪ number of sockets: 4× 2P + PE SCHUKO ▪ voltage/current: 250 V~/16 A max. ▪ maximum load: 3 680 W ▪ type of insulation: rubber/neopren ▪ conductor: H07RN-F3G 1.5 mm² ▪ material of the sockets + plugs: plastic / ▪ packaging: 1 pc, foil 		





P14201	1/-/-/6	
19 22 341 000	E-K-4E	
		
<ul style="list-style-type: none"> ▪ length: 10 m ▪ number of sockets: 4× 2P + PE SCHUKO ▪ voltage/current: 250 V~/16 A max. ▪ maximum load: 3 680 W ▪ type of insulation: rubber/neopren ▪ conductor: H07RN-F3G 1.5 mm² ▪ material of the sockets + plugs: plastic / ▪ packaging: 1 pc, foil 		

1-phase 16A with PVC insulation





- extension cables with PVC insulation are ideal for household
- conductor: 1.5 mm² (1.0 mm² up to 2 m) round sockets
- round sockets, with or without switch
- various lengths, max. load: 3 680 W, child socket covers
- in white – to blend discreetly into the interior

P0321R	1/5/-/20	
19 22 030 153	SE0311-1,5	
	 	
8 592920 052662		





- length: 1.5 m
- number of sockets: 3× 2P + PE SCHUKO
- voltage/current: 250 V~/16 A max.
- maximum load: 3 680 W
- type of insulation: PVC
- conductor: H05VV-F3G 1.5 mm²
- material of the sockets + plugs: plastic
- packaging: 1 pc, hanging

P0323R	1/5/-/20	
19 22 030 308	SE0313-1,5	
	 	
8 592920 016336		





- length: 3 m
- number of sockets: 3× 2P + PE SCHUKO
- voltage/current: 250 V~/16 A max.
- maximum load: 3 680 W
- type of insulation: PVC
- conductor: H05VV-F3G 1.5 mm²
- material of the sockets + plugs: plastic
- packaging: 1 pc, hanging

P0325R	1/5/-/15	
19 22 030 508	SE0315-1,5	
	 	
8 592920 016343		





- length: 5 m
- number of sockets: 3× 2P + PE SCHUKO
- voltage/current: 250 V~/16 A max.
- maximum load: 3 680 W
- type of insulation: PVC
- conductor: H05VV-F3G 1.5 mm²
- material of the sockets + plugs: plastic
- packaging: 1 pc, hanging

P0421R	1/5/-/20	
19 22 040 152	SE0411-1,5	
	 	
8 592920 052679		





- length: 1.5 m
- number of sockets: 4× 2P + PE SCHUKO
- voltage/current: 250 V~/16 A max.
- maximum load: 3 680 W
- type of insulation: PVC
- conductor: H05VV-F3G 1.5 mm²
- material of the sockets + plugs: plastic
- packaging: 1 pc, hanging

P0423R	1/5/-/20	
19 22 040 302	SE0413-1,5	
	 	
8 592920 052747		





- length: 3 m
- number of sockets: 4× 2P + PE SCHUKO
- voltage/current: 250 V~/16 A max.
- maximum load: 3 680 W
- type of insulation: PVC
- conductor: H05VV-F3G 1.5 mm²
- material of the sockets + plugs: plastic
- packaging: 1 pc, hanging

P0425R	1/5/-/15	
19 22 040 502	SE0415-1,5 (SEH0415-1,5)	
	 	
8 592920 064429		

- length: 5 m
- number of sockets: 4× 2P + PE SCHUKO
- voltage/current: 250 V~/16 A max.
- maximum load: 3 680 W
- type of insulation: PVC
- conductor: H05VV-F3G 1.5 mm²
- material of the sockets + plugs: plastic
- packaging: 1 pc, hanging

P0521R	1/5/-/15	
19 22 050 153	SE0511-1,5	
	 	
8 592920 052686		

- length: 1.5 m
- number of sockets: 5× 2P + PE SCHUKO
- voltage/current: 250 V~/16 A max.
- maximum load: 3 680 W
- type of insulation: PVC
- conductor: H05VV-F3G 1.5 mm²
- material of the sockets + plugs: plastic
- packaging: 1 pc, hanging

P0523R	1/-/-/15	
19 22 050 308	SE0513-1,5	
	 	
8 592920 016374		

- length: 3 m
- number of sockets: 5× 2P + PE SCHUKO
- voltage/current: 250 V~/16 A max.
- maximum load: 3 680 W
- type of insulation: PVC
- conductor: H05VV-F3G 1.5 mm²
- material of the sockets + plugs: plastic
- packaging: 1 pc, hanging



www.emos.eu

Order Code
Item Number

Packaging
Type

P0525R 1/-/-/10
19 22 050 508
SE0515-1,5
(SEH0515-1.5)

- length: 5 m
- number of sockets: 5× 2P + PE SCHUKO
- voltage/current: 250 V~/16 A max.
- maximum load: 3 680 W
- type of insulation: PVC
- conductor: H05VV-F3G 1.5 mm²
- material of the sockets + plugs: plastic
- packaging: 1 pc, hanging

P0623R 1/-/-/10
19 22 060 302
SE0613-1,5

- length: 3 m
- number of sockets: 6× 2P + PE SCHUKO
- voltage/current: 250 V~/16 A max.
- maximum load: 3 680 W
- type of insulation: PVC
- conductor: H05VV-F3G 1.5 mm²
- material of the sockets + plugs: plastic
- packaging: 1 pc, hanging

P0625R 1/-/-/10
19 22 060 502
SE0615-1,5

- length: 5 m
- number of sockets: 6× 2P + PE SCHUKO
- voltage/current: 250 V~/16 A max.
- maximum load: 3 680 W
- type of insulation: PVC
- conductor: H05VV-F3G 1.5 mm²
- material of the sockets + plugs: plastic
- packaging: 1 pc, hanging

P1321R 1/-/-/15
19 22 130 156
SE1311-1,5

- length: 1.5 m
- number of sockets: 3× 2P + PE SCHUKO
- voltage/current: 250 V~/16 A max.
- maximum load: 3 680 W
- type of insulation: PVC
- conductor: H05VV-F3G 1.5 mm²
- material of the sockets + plugs: plastic
- packaging: 1 pc, hanging

P1323R 1/5/-/20
19 22 130 308
SE1313-1,5
(SEH1313-1.5)

- length: 3 m
- number of sockets: 3× 2P + PE SCHUKO
- voltage/current: 250 V~/16 A max.
- maximum load: 3 680 W
- type of insulation: PVC
- conductor: H05VV-F3G 1.5 mm²
- material of the sockets + plugs: plastic
- packaging: 1 pc, hanging

P1325R 1/-/-/10
19 22 130 508
SE1315-1,5
(SEH1315-1.5)

- length: 5 m
- number of sockets: 3× 2P + PE SCHUKO
- voltage/current: 250 V~/16 A max.
- maximum load: 3 680 W
- type of insulation: PVC
- conductor: H05VV-F3G 1.5 mm²
- material of the sockets + plugs: plastic
- packaging: 1 pc, hanging

P1421R 1/-/-/15
19 22 140 152
SE1411-1,5

- length: 1.5 m
- number of sockets: 4× 2P + PE SCHUKO
- voltage/current: 250 V~/16 A max.
- maximum load: 3 680 W
- type of insulation: PVC
- conductor: H05VV-F3G 1.5 mm²
- material of the sockets + plugs: plastic
- packaging: 1 pc, hanging

P1423R 1/-/-/10
19 22 140 303
SE1413-1,5
(SEH1413-1.5)

- length: 3 m
- number of sockets: 4× 2P + PE SCHUKO
- voltage/current: 250 V~/16 A max.
- maximum load: 3 680 W
- type of insulation: PVC
- conductor: H05VV-F3G 1.5 mm²
- material of the sockets + plugs: plastic
- packaging: 1 pc, hanging

P1425R 1/5/-/15
19 22 140 503
SE1415-1,5
(SEH1415-1.5)

- length: 5 m
- number of sockets: 4× 2P + PE SCHUKO
- voltage/current: 250 V~/16 A max.
- maximum load: 3 680 W
- type of insulation: PVC
- conductor: H05VV-F3G 1.5 mm²
- material of the sockets + plugs: plastic
- packaging: 1 pc, hanging

P1521R 1/-/-/15
19 22 150 154
SE1511-1,5

- length: 1.5 m
- number of sockets: 5× 2P + PE SCHUKO
- voltage/current: 250 V~/16 A max.
- maximum load: 3 680 W
- type of insulation: PVC
- conductor: H05VV-F3G 1.5 mm²
- material of the sockets + plugs: plastic
- packaging: 1 pc, hanging



www.emos.eu

Order Code
Item Number

Packaging
Type

P1523R 1/-/-/10
19 22 150 308
SE1513-1,5
(SEH1513-1.5)

- length: 3 m
- number of sockets: 5× 2P + PE SCHUKO
- voltage/current: 250 V~/16 A max.
- maximum load: 3 680 W
- type of insulation: PVC
- conductor: H05VV-F3G 1.5 mm²
- material of the sockets + plugs: plastic
- packaging: 1 pc, hanging

P1525R 1/-/-/10
19 22 150 508
SE1515-1,5
(SEH1515-1.5)

- length: 5 m
- number of sockets: 5× 2P + PE SCHUKO
- voltage/current: 250 V~/16 A max.
- maximum load: 3 680 W
- type of insulation: PVC
- conductor: H05VV-F3G 1.5 mm²
- material of the sockets + plugs: plastic
- packaging: 1 pc, hanging

P1621R 1/-/-/15
19 22 160 152
SE1611-1,5

- length: 1.5 m
- number of sockets: 6× 2P + PE SCHUKO
- voltage/current: 250 V~/16 A max.
- maximum load: 3 680 W
- type of insulation: PVC
- conductor: H05VV-F3G 1.5 mm²
- material of the sockets + plugs: plastic
- packaging: 1 pc, hanging

P1623R 1/-/-/10
19 22 160 302
SE1613-1,5

- length: 3 m
- number of sockets: 6× 2P + PE SCHUKO
- voltage/current: 250 V~/16 A max.
- maximum load: 3 680 W
- type of insulation: PVC
- conductor: H05VV-F3G 1.5 mm²
- material of the sockets + plugs: plastic
- packaging: 1 pc, hanging

P1625R 1/-/-/10
19 22 160 502
SE1615-1,5
(SEH1615-1.5)

- length: 5 m
- number of sockets: 6× 2P + PE SCHUKO
- voltage/current: 250 V~/16 A max.
- maximum load: 3 680 W
- type of insulation: PVC
- conductor: H05VV-F3G 1.5 mm²
- material of the sockets + plugs: plastic
- packaging: 1 pc, hanging

P1523RU 1/-/-/10
19 22 150 304
P1523RU

- length: 3 m
- number of sockets: 5× 2P + PE SCHUKO
- voltage/current: 250 V~/16 A max.
- maximum load: 3 680 W
- type of insulation: PVC
- conductor: H05VV-F3G 1.5 mm²
- material of the sockets + plugs: plastic
- packaging: 1 pc, hanging

PC1321R 1/-/-/15
19 22 330 152
SE1311-1,5

- length: 1.5 m
- number of sockets: 3× 2P + PE SCHUKO
- voltage/current: 250 V~/16 A max.
- maximum load: 3 680 W
- type of insulation: PVC
- conductor: H05VV-F3G 1.5 mm²
- material of the sockets + plugs: plastic
- packaging: 1 pc, hanging

PC1421R 1/-/-/15
19 22 340 151
SE1411-1,5

- length: 1.5 m
- number of sockets: 4× 2P + PE SCHUKO
- voltage/current: 250 V~/16 A max.
- maximum load: 3 680 W
- type of insulation: PVC
- conductor: H05VV-F3G 1.5 mm²
- material of the sockets + plugs: plastic
- packaging: 1 pc, hanging

PC1423R 1/-/-/10
19 22 340 301
SE1413-1,5

- length: 3 m
- number of sockets: 4× 2P + PE SCHUKO
- voltage/current: 250 V~/16 A max.
- maximum load: 3 680 W
- type of insulation: PVC
- conductor: H05VV-F3G 1.5 mm²
- material of the sockets + plugs: plastic
- packaging: 1 pc, hanging

PC1425R 1/-/-/15
19 22 340 502
SE1415-1,5

- length: 5 m
- number of sockets: 4× 2P + PE SCHUKO
- voltage/current: 250 V~/16 A max.
- maximum load: 3 680 W
- type of insulation: PVC
- conductor: H05VV-F3G 1.5 mm²
- material of the sockets + plugs: plastic
- packaging: 1 pc, hanging



www.emos.eu

Order Code
Item Number

Packaging
Type

PC1521R 1/-/-15
19 22 350 151 SE1511-1,5





- length: 1.5 m
- number of sockets: 5× 2P + PE SCHUKO
- voltage/current: 250 V~/16 A max.
- maximum load: 3 680 W
- type of insulation: PVC
- conductor: H05VV-F3G 1.5 mm²
- material of the sockets + plugs: plastic
- packaging: 1 pc, hanging



PC1621R 1/-/-15
19 22 360 150 SE1611-1,5







- length: 1.5 m
- number of sockets: 6× 2P + PE SCHUKO
- voltage/current: 250 V~/16 A max.
- maximum load: 3 680 W
- type of insulation: PVC
- conductor: H05VV-F3G 1.5 mm²
- material of the sockets + plugs: plastic
- packaging: 1 pc, hanging

P0321 1/5/-/20
19 22 030 150 SE0311



- length: 1.5 m
- number of sockets: 3× 2P + PE SCHUKO
- voltage/current: 250 V~/16 A max.
- maximum load: 3 680 W
- type of insulation: PVC
- conductor: H05VV-F3G 1 mm²
- material of the sockets + plugs: plastic
- packaging: 1 pc, hanging

P0322 1/5/-/20
19 22 030 200 SE0312

- length: 2 m
- number of sockets: 3× 2P + PE SCHUKO
- voltage/current: 250 V~/16 A max.
- maximum load: 3 680 W
- type of insulation: PVC
- conductor: H05VV-F3G 1 mm²
- material of the sockets + plugs: plastic
- packaging: 1 pc, hanging

P0421 1/5/-/20
19 22 040 150 SE0411

- length: 1.5 m
- number of sockets: 4× 2P + PE SCHUKO
- voltage/current: 250 V~/16 A max.
- maximum load: 3 680 W
- type of insulation: PVC
- conductor: H05VV-F3G 1 mm²
- material of the sockets + plugs: plastic
- packaging: 1 pc, hanging



P0521 1/5/-/15
19 22 050 150 SE0511







- length: 1.5 m
- number of sockets: 5× 2P + PE SCHUKO
- voltage/current: 250 V~/10 A max.
- maximum load: 2 300 W
- type of insulation: PVC
- conductor: H05VV-F3G 1.0 mm²
- material of the sockets + plugs: plastic
- packaging: 1 pc, hanging

P0622 1/5/-/15
19 22 060 200 SE0612



- length: 2 m
- number of sockets: 6× 2P + PE SCHUKO
- voltage/current: 230 V~/10 A max.
- maximum load: 2 300 W
- type of insulation: PVC
- conductor: H05VV-F3G 1.0 mm²
- material of the sockets + plugs: plastic
- packaging: 1 pc, hanging

P1321 1/5/-/20
19 22 130 150 SE1311



- length: 1.5 m
- number of sockets: 3× 2P + PE SCHUKO
- voltage/current: 250 V~/16 A max.
- maximum load: 3 680 W
- type of insulation: PVC
- conductor: H05VV-F3G 1 mm²
- material of the sockets + plugs: plastic
- packaging: 1 pc, hanging

P1322 1/5/-/20
19 22 130 200 SE1312

- length: 2 m
- number of sockets: 3× 2P + PE SCHUKO
- voltage/current: 250 V~/16 A max.
- maximum load: 3 680 W
- type of insulation: PVC
- conductor: H05VV-F3G 1 mm²
- material of the sockets + plugs: plastic
- packaging: 1 pc, hanging

P1422 1/5/-/20
19 22 140 200 SE1412

- length: 2 m
- number of sockets: 4× 2P + PE SCHUKO
- voltage/current: 250 V~/16 A max.
- maximum load: 3 680 W
- type of insulation: PVC
- conductor: H05VV-F3G 1 mm²
- material of the sockets + plugs: plastic
- packaging: 1 pc, hanging





www.emos.eu

Order Code
Item Number



Packaging
Type

P1522 1/5/-/15
19 22 150 200 SE1512

- length: 2 m
- number of sockets: 5× 2P + PE SCHUKO
- voltage/current: 250 V~/16 A max.
- maximum load: 3 680 W
- type of insulation: PVC
- conductor: H05VV-F3G 1 mm²
- material of the sockets + plugs: plastic
- packaging: 1 pc, hanging

P1622 1/-/-/10
19 22 160 200 SE1612

- length: 2 m
- number of sockets: 6× 2P + PE SCHUKO
- voltage/current: 250 V~/10 A max.
- maximum load: 2 300 W
- type of insulation: PVC
- conductor: H05VV-F3G 1.0 mm²
- material of the sockets + plugs: plastic
- packaging: 1 pc, hanging



PC1321 1/5/-/20
19 22 330 150 SE1311







- length: 1.5 m
- number of sockets: 3× 2P + PE SCHUKO
- voltage/current: 250 V~/16 A max.
- maximum load: 3 680 W
- type of insulation: PVC
- conductor: H05VV-F3G 1 mm²
- material of the sockets + plugs: plastic
- packaging: 1 pc, hanging

P04219GU 1/-/3/12
19 22 040 191 P04219U



- length: 1.9 m
- number of sockets: 4× 2P + PE SCHUKO
- voltage/current: 250 V~/16 A max.
- maximum load: 3 680 W
- type of insulation: PVC
- conductor: H05VV-F3G 1.5 mm²
- material of the sockets + plugs: PC
- packaging: 1 pc, box

PS1721 1/5/10/20
19 22 570 150 GES-002

- length: 1.5 m
- number of sockets: 3× 2P + PE + 4× 2P
- voltage/current: 250 V~/10 A max.
- maximum load: 2 300 W
- type of insulation: PVC
- conductor: H05VV-F3G 1 mm²
- material of the sockets + plugs: plastic
- packaging: 1 pc, hanging

P0221U 1/5/-/20
19 02 020 150 P0221U



- length: 1.5 m
- material of the sockets + plugs: plastic
- maximum load: 3 680 W
- voltage/current: 250 V~/16 A max.
- number of sockets: 2× 2P + PE
- packaging: 1 pc, hanging
- type of insulation: PVC
- conductor: H05VV-F3G 1.5 mm²

P1321PD 1/-/-/10
19 02 330 154 P1321PD





- length: 1.5 m
- number of sockets: 3× 2P + PE SCHUKO
- maximum load: 3 680 W
- conductor cross section: 1.5 mm²
- conductor: H05VV-F
- type of insulation: PVC
- children protection
- packaging: 1 ks, box

P0121 1/5/-/20
19 22 010 150 P0121



- length: 1.4 m
- number of sockets: 1× 2P + PE SCHUKO
- voltage/current: 250 V~/16 A max.
- maximum load: 3 680 W
- type of insulation: PVC
- conductor: H05VV-F3G 1.0 mm²
- material of the sockets + plugs: plastic
- packaging: 1 pc, hanging

P0422 1/5/-/20
19 22 040 400 SE0412

- length: 2 m
- number of sockets: 4× 2P + PE SCHUKO
- voltage/current: 250 V~/16 A max.
- maximum load: 3 680 W
- type of insulation: PVC
- conductor: H05VV-F3G 1.0 mm²
- material of the sockets + plugs: plastic
- packaging: 1 pc, hanging

P0522 1/5/-/20
19 22 050 201 SE0512



- length: 2 m
- number of sockets: 5× 2P + PE SCHUKO
- voltage/current: 250 V~/16 A max.
- maximum load: 3 680 W
- type of insulation: PVC
- conductor: H05VV-F3G 1.0 mm²
- material of the sockets + plugs: plastic
- packaging: 1 pc, hanging







www.emos.eu



Order Code
Item Number



Packaging
Type



P0621	1/5/-/15	
19 22 060 151	SE0611	
		
<ul style="list-style-type: none"> ▪ length: 1.4 m ▪ number of sockets: 6× 2P + PE SCHUKO ▪ voltage/current: 250 V~/16 A max. ▪ maximum load: 3 680 W ▪ type of insulation: PVC ▪ conductor: H05VV-F3G 1.0 mm² <ul style="list-style-type: none"> ▪ material of the sockets + plugs: plastic ▪ packaging: 1 pc, hanging 		



P0222CQ	1/-/5/10	
19 22 120 200	P0222CQ	
		
<ul style="list-style-type: none"> ▪ length: 2 m ▪ number of sockets: 2× 2P + PE SCHUKO ▪ voltage/current: 250 V~/16 A max. ▪ maximum load: 3 680 W ▪ type of insulation: PVC ▪ conductor: H05VV-F3G 1.5 mm² <ul style="list-style-type: none"> ▪ material of the sockets + plugs: PC ▪ packaging: 1 pc, box 		

P1421	1/5/-/20	
19 22 140 153	SE1411	
		
<ul style="list-style-type: none"> ▪ length: 1.4 m ▪ number of sockets: 4× 2P + PE SCHUKO ▪ voltage/current: 250 V~/16 A max. ▪ maximum load: 3 680 W ▪ type of insulation: PVC ▪ conductor: H05VV-F3G 1.0 mm² <ul style="list-style-type: none"> ▪ material of the sockets + plugs: plastic ▪ packaging: 1 pc, hanging 		

P1521	1/5/-/15	
19 22 150 155	SE1511	
		
<ul style="list-style-type: none"> ▪ length: 1.4 m ▪ number of sockets: 5× 2P + PE SCHUKO ▪ voltage/current: 250 V~/16 A max. ▪ maximum load: 3 680 W ▪ type of insulation: PVC ▪ conductor: H05VV-F3G 1.0 mm² <ul style="list-style-type: none"> ▪ material of the sockets + plugs: plastic ▪ packaging: 1 pc, hanging 		

P1523PD	1/-/5/10	
19 22 150 305	P1523PD	
		
<ul style="list-style-type: none"> ▪ length: 3 m ▪ number of sockets: 5× 2P + PE SCHUKO ▪ voltage/current: 250 V~/16 A max. ▪ maximum load: 3 680 W ▪ type of insulation: PVC ▪ conductor: H05VV-F3G 1.5 mm² <ul style="list-style-type: none"> ▪ material of the sockets + plugs: PC ▪ packaging: 1 pc, box 		

P1523CU	1/5/-/10	
19 22 150 306	P1523CU	
		
<ul style="list-style-type: none"> ▪ length: 3 m ▪ number of sockets: 5× 2P + PE SCHUKO ▪ voltage/current: 250 V~/16 A max. ▪ maximum load: 3 680 W ▪ type of insulation: PVC ▪ conductor: H05VV-F3G 1.5 mm² <ul style="list-style-type: none"> ▪ material of the sockets + plugs: plastic ▪ packaging: 1 pc, hanging 		

P1621	1/5/-/10	
19 22 160 153	SE1611	
		
<ul style="list-style-type: none"> ▪ length: 1.4 m ▪ number of sockets: 6× 2P + PE SCHUKO ▪ voltage/current: 250 V~/16 A max. ▪ maximum load: 3 680 W ▪ type of insulation: PVC ▪ conductor: H05VV-F3G 1.0 mm² <ul style="list-style-type: none"> ▪ material of the sockets + plugs: plastic ▪ packaging: 1 pc, hanging 		

Power supply extension cords and sockets

SCHUKO

Single socket extension cords

1-phase 16A with rubber insulation

- extension cable with 1 or 2 sockets, length 5–30 m
- neoprene or rubber insulation, IP44 enclosure
- conductor cross-section: 1.5 or 2.5 mm, max. load: 3 680 W
- black colour, round socket with lid, child socket covers

P01805	1/-/-/12	
19 21 010 504	P01805 (E-008)	
	 	
<ul style="list-style-type: none"> ▪ length: 5 m ▪ conductor cross section: 1.5 mm² ▪ voltage: 230 V ▪ current: 16 A ▪ IP rating: IP44 ▪ number of sockets: 1 	<ul style="list-style-type: none"> ▪ thermal fuse: no ▪ conductor: H07RN-F3G ▪ max. unreel load: 16 A max./3 680 W ▪ children protection ▪ packaging: 1 pc, shrink 	

P01810	1/-/-/3	
19 21 031 000	P01810 (E-008)	
	 	
<ul style="list-style-type: none"> ▪ length: 10 m ▪ conductor cross section: 1.5 mm² ▪ voltage: 230 V ▪ current: 16 A ▪ IP rating: IP44 ▪ number of sockets: 1 	<ul style="list-style-type: none"> ▪ thermal fuse: no ▪ conductor: H07RN-F3G ▪ max. unreel load: 16 A max./3 680 W ▪ children protection ▪ packaging: 1 pc, shrink 	





P01820	1/-/-/2	
19 21 032 000	P01820 (E-008)	
	 	
<ul style="list-style-type: none"> ▪ length: 20 m ▪ conductor cross section: 1.5 mm² ▪ voltage: 230 V ▪ current: 16 A ▪ IP rating: IP44 ▪ number of sockets: 1 	<ul style="list-style-type: none"> ▪ thermal fuse: no ▪ conductor: H07RN-F3G ▪ max. unreel load: 16 A max./3 680 W ▪ children protection ▪ packaging: 1 pc, shrink 	





P01830	1/-/-/2	
19 21 033 000	P01830 (E-008)	
	 	
<ul style="list-style-type: none"> ▪ length: 30 m ▪ conductor cross section: 1.5 mm² ▪ voltage: 230 V ▪ current: 16 A ▪ IP rating: IP44 ▪ number of sockets: 1 	<ul style="list-style-type: none"> ▪ thermal fuse: no ▪ conductor: H07RN-F3G ▪ max. unreel load: 16 A max./3 680 W ▪ children protection ▪ packaging: 1 pc, shrink 	

P01810R	1/-/-/3	
19 21 011 003	P01810R (E-008)	
	 	
<ul style="list-style-type: none"> ▪ length: 10 m ▪ conductor cross section: 2.5 mm² ▪ voltage: 230 V ▪ current: 16 A ▪ IP rating: IP44 ▪ number of sockets: 1 	<ul style="list-style-type: none"> ▪ thermal fuse: no ▪ conductor: H07RN-F3G ▪ max. unreel load: 16 A max./3 680 W ▪ children protection ▪ packaging: 1 pc, shrink 	





P01825R	1/-/-/4	
19 21 012 502	P01825R (E-008)	
	 	
<ul style="list-style-type: none"> ▪ length: 25 m ▪ conductor cross section: 2.5 mm² ▪ voltage: 230 V ▪ current: 16 A ▪ IP rating: IP44 ▪ number of sockets: 1 	<ul style="list-style-type: none"> ▪ thermal fuse: no ▪ conductor: H07RN-F3G ▪ max. unreel load: 16 A max./3 680 W ▪ children protection ▪ packaging: 1 pc, shrink 	



P0701	1/-/-/6	
19 21 021 000	E-012	
	 10 m	 H05RR-F3G 1.5 mm ²
<ul style="list-style-type: none"> ▪ length: 10 m ▪ conductor cross section: 1.5 mm² ▪ voltage: 230 V ▪ current: 16 A ▪ IP rating: IP44 ▪ number of sockets: 2 	<ul style="list-style-type: none"> ▪ thermal fuse: no ▪ conductor: H05RR-F3G ▪ max. unreel load: 16 A max./3 680 W ▪ children protection ▪ packaging: 1 pc, shrink 	

P0702	1/-/-/4	
19 21 021 502	E-012	
	 15 m	 H05RR-F3G 1.5 mm ²
<ul style="list-style-type: none"> ▪ length: 15 m ▪ conductor cross section: 1.5 mm² ▪ voltage: 230 V ▪ current: 16 A ▪ IP rating: IP44 ▪ number of sockets: 2 	<ul style="list-style-type: none"> ▪ thermal fuse: no ▪ conductor: H05RR-F3G ▪ max. unreel load: 16 A max./3 680 W ▪ children protection ▪ packaging: 1 pc, shrink 	

P0703	1/-/-/3	
19 21 022 000	E-012	
	 20 m	 H05RR-F3G 1.5 mm ²
<ul style="list-style-type: none"> ▪ length: 20 m ▪ conductor cross section: 1.5 mm² ▪ voltage: 230 V ▪ current: 16 A ▪ IP rating: IP44 ▪ number of sockets: 2 	<ul style="list-style-type: none"> ▪ thermal fuse: no ▪ conductor: H05RR-F3G ▪ max. unreel load: 16 A max./3 680 W ▪ children protection ▪ packaging: 1 pc, shrink 	

P0704	1/-/-/2	
19 21 022 502	E-012	
	 25 m	 H05RR-F3G 1.5 mm ²
<ul style="list-style-type: none"> ▪ length: 25 m ▪ conductor cross section: 1.5 mm² ▪ voltage: 230 V ▪ current: 16 A ▪ IP rating: IP44 ▪ number of sockets: 2 	<ul style="list-style-type: none"> ▪ thermal fuse: no ▪ conductor: H05RR-F3G ▪ max. unreel load: 16 A max./3 680 W ▪ children protection ▪ packaging: 1 pc, shrink 	

1-phase 16A with PVC weatherproof insulation





- extension cable with 1 socket, weather-proof insulation
- IP44 protection allows outdoor use
- wire cross-section: 1.5 mm², max. load 3 680 W
- length: 10 and 20 metres, blue
- round socket with cover, child safety covers





P01510W	1/-/-/6	
19 21 611 000	P01510W	
		
<ul style="list-style-type: none"> ▪ length: 10 m ▪ conductor cross section: 1.5 mm² ▪ voltage: 250 V~ ▪ current: 16 A ▪ IP rating: IP44 ▪ number of sockets: 1 	<ul style="list-style-type: none"> ▪ thermal fuse: no ▪ conductor: AT-N05V3V3-F ▪ max. unreel load: 16 A max./3 680 W ▪ children protection ▪ packaging: 1 pc, packet 	





P01520W	1/-/-/2	
19 21 612 000	P01520W	
		
<ul style="list-style-type: none"> ▪ length: 20 m ▪ conductor cross section: 1.5 mm² ▪ voltage: 250 V~ ▪ current: 16 A ▪ IP rating: IP44 ▪ number of sockets: 1 	<ul style="list-style-type: none"> ▪ thermal fuse: no ▪ conductor: AT-N05V3V3-F ▪ max. unreel load: 16 A max./3 680 W ▪ children protection ▪ packaging: 1 pc, packet 	





1-phase 16A with PVC insulation





- 2–30 m extension cable with one socket
- conductor cross section: 1.5 mm, max. load: 3 680 W
- PVC insulation - ideal for the garage or workshop
- orange reflective colour - always visible to avoid tripping
- round socket, child socket covers

P0123R	1/5/-/20	
19 21 010 302	SE0113-1,5	
		
<ul style="list-style-type: none"> ▪ length: 3 m ▪ number of sockets: 1× 2P + PE SCHUKO ▪ voltage/current: 250 V~/16 A max. ▪ maximum load: 3 680 W ▪ type of insulation: PVC ▪ conductor: H05VV-F3G 1.5 mm² 		
<ul style="list-style-type: none"> ▪ material of the sockets + plugs: plastic ▪ packaging: 1 pc, foil+hanging 		

P0125R	1/-/-/20	
19 21 010 503	SE0115-1,5	
		
<ul style="list-style-type: none"> ▪ length: 5 m ▪ number of sockets: 1× 2P + PE SCHUKO ▪ voltage/current: 250 V~/16 A max. ▪ maximum load: 3 680 W ▪ type of insulation: PVC ▪ conductor: H05VV-F3G 1.5 mm² 		
<ul style="list-style-type: none"> ▪ material of the sockets + plugs: plastic ▪ packaging: 1 pc, hanging 		

P0127R	1/-/-/20	
19 21 010 701	SE0117-1,5	
		
<ul style="list-style-type: none"> ▪ length: 7 m ▪ number of sockets: 1× 2P + PE SCHUKO ▪ voltage/current: 250 V~/16 A max. ▪ maximum load: 3 680 W ▪ type of insulation: PVC ▪ conductor: H05VV-F3G 1.5 mm² 		
<ul style="list-style-type: none"> ▪ material of the sockets + plugs: plastic ▪ packaging: 1 pc, foil+hanging 		

P0120R	1/-/-/10	
19 21 011 002	SE0110-1,5	
		
<ul style="list-style-type: none"> ▪ length: 10 m ▪ number of sockets: 1× 2P + PE SCHUKO ▪ voltage/current: 250 V~/16 A max. ▪ maximum load: 3 680 W ▪ type of insulation: PVC ▪ conductor: H05VV-F3G 1.5 mm² 		
<ul style="list-style-type: none"> ▪ material of the sockets + plugs: plastic ▪ packaging: 1 pc, foil+hanging 		

P0122	1/5/-/20	
19 21 010 202	P0122	
		
<ul style="list-style-type: none"> ▪ length: 2 m ▪ number of sockets: 1× 2P + PE SCHUKO ▪ voltage/current: 250 V~/16 A max. ▪ maximum load: 3 680 W ▪ type of insulation: PVC ▪ conductor: H05VV-F3G 1.0 mm² 		
<ul style="list-style-type: none"> ▪ material of the sockets + plugs: plastic ▪ packaging: 1 pc, foil+hanging 		

P01215R	1/-/-/6	
19 21 011 502	DG-YD01 (YC-DAX-2)	
		
<ul style="list-style-type: none"> ▪ length: 15 m ▪ conductor cross section: 1.5 mm² ▪ voltage: 230 V ▪ current: 16 A ▪ IP rating: IP20 ▪ number of sockets: 1 		
<ul style="list-style-type: none"> ▪ thermal fuse: no ▪ conductor: H05VV-F3G ▪ max. unreeled load: 16 A max./3 680 W ▪ children protection ▪ packaging: 1 pc, shrink 		

P01220R	1/-/-/6	
19 21 012 001	DG-YD01 (YC-DAX-2)	
		
<ul style="list-style-type: none"> ▪ length: 20 m ▪ conductor cross section: 1.5 mm² ▪ voltage: 230 V ▪ current: 16 A ▪ IP rating: IP20 ▪ number of sockets: 1 		
<ul style="list-style-type: none"> ▪ thermal fuse: no ▪ conductor: H05VV-F3G ▪ max. unreeled load: 16 A max./3 680 W ▪ children protection ▪ packaging: 1 pc, shrink 		

P01225R	1/-/-/4	
19 21 012 500	DG-YD01 (YC-DAX-2)	
		
<ul style="list-style-type: none"> ▪ length: 25 m ▪ conductor cross section: 1.5 mm² ▪ voltage: 230 V ▪ current: 16 A ▪ IP rating: IP20 ▪ number of sockets: 1 		
<ul style="list-style-type: none"> ▪ thermal fuse: no ▪ conductor: H05VV-F3G ▪ max. unreeled load: 16 A max./3 680 W ▪ children protection ▪ packaging: 1 pc, shrink 		



www.emos.eu

Order Code
Item Number

Packaging
Type

P01230R 1/-/-/4
19 21 013 001 P01230R



- length: 30 m
- conductor cross section: 1.5 mm²
- voltage: 230 V
- current: 16 A
- IP rating: IP20
- number of sockets: 1
- thermal fuse: no
- conductor: H05VV-F3G
- children protection
- packaging: 1 pc, shrink

Power supply extension cords and sockets

SCHUKO

MOES

- demountable multi sockets
- max. current load: 16 A, IP20 enclosure
- plastic, white
- fitted with child socket covers

P0320 1/5/-/40
19 23 030 000 DG-DC03 (P03C)



- product: socket field
- voltage/current: 250 V~/16 A max.
- children protection
- IP rating: IP20
- material: plastic
- packaging: 1 pc, hanging

P0520 1/5/-/30
19 23 050 000 DG-DC05 (P05C)



- product: socket field
- voltage/current: 250 V~/16 A max.
- children protection
- IP rating: IP20
- material: plastic
- packaging: 1 pc, hanging

P1320 1/5/-/45
19 23 130 000 DG-DC03K (P13C)



- product: socket field
- voltage/current: 250 V~/16 A max.
- children protection
- IP rating: IP20
- material: plastic
- packaging: 1 pc, hanging

P1520 1/5/-/20
19 23 150 000 DG-DC05K (P15C)



- product: socket field
- voltage/current: 250 V~/16 A max.
- children protection
- IP rating: IP20
- material: plastic
- packaging: 1 pc, hanging

Surge protectors

Surge protectors EMOS SCHUKO

- extension cable with overvoltage protection
- protects TV, satellite or laptop from mains overvoltage
- black or white design, backlit switch & child socket covers

- rated voltage: 230 V~, 50 Hz
- maximum load: 3 680 W
- conductor: H05VV-F3G 1.5 mm²
- energy absorption: 900 J
- protection level Up: 1.7 kV (L/N-PE, L-N)
- open-circuit voltage UOC: 6 kV
- response time: <1 ns
- connection indicator
- surge protector indicator

- dimensions: 342 × 66 × 50 mm
- packaging: 1 pc, box

**P54212**

1/-/-/6

19 09 040 202

G3040

- rated voltage: 230 V~, 50 Hz
- maximum load: 3 680 W
- conductor: H05VV-F3G 1.5 mm²
- energy absorption: 1 800 J
- protection level Up: 1.7 kV (L/N-PE, L-N)
- open-circuit voltage UOC: 6 kV
- response time: <1 ns
- antenna (coaxial protection): yes, IEC
- connection indicator

- surge protector indicator
- dimensions: 342 × 66 × 50 mm
- packaging: 1 pc, box

**P54222**

1/-/-/6

19 09 040 203

G5142

- rated voltage: 230 V~, 50 Hz
- maximum load: 3 680 W
- conductor: H05VV-F3G 1.5 mm²
- energy absorption: 1 800 J
- protection level Up: 1.7 kV (L/N-PE, L-N)
- open-circuit voltage UOC: 6 kV
- response time: <1 ns
- tel./Fax/DSL protection: yes, tel./fax/DSL,RJ11/RJ
- antenna (coaxial protection): yes, IEC

- connection indicator
- surge protector indicator
- dimensions: 398 × 110 × 50 mm
- packaging: 1 pc, box

**P54252**

1/-/-/6





19 09 480 301





G5183





Assembled cords





3-phase rubber





- 380 V~ extension cable, length: 5–25 m
- rubber insulation, ideal for outdoor use, enclosure: IP44
- conductor cross-section: 2.5 or 4.0 mm²
- max. load: 3 680 W or 22 000 W





PM0902	1/-/-/2	
19 14 071 100	PM0902	
	 10 m	 H05RR-F 2.5 mm ²
<ul style="list-style-type: none"> ▪ length: 10 m ▪ conductor cross section: 2.5 mm² ▪ voltage: 400 V~ ▪ current: 16 A ▪ IP rating: IP44 ▪ number of sockets: 1 		
<ul style="list-style-type: none"> ▪ thermal fuse: no ▪ conductor: CGSG 5C × H05RR-F ▪ max. unreel load: 16 A max./11 040 W ▪ children protection: no ▪ packaging: 1 pc, packet 		

PM0904	1/-/-/2	
19 14 071 200	PM0904	
	 20 m	 H05RR-F 2.5 mm ²
<ul style="list-style-type: none"> ▪ length: 20 m ▪ conductor cross section: 2.5 mm² ▪ voltage: 400 V~ ▪ current: 16 A ▪ IP rating: IP44 ▪ number of sockets: 1 		
<ul style="list-style-type: none"> ▪ thermal fuse: no ▪ conductor: CGSG 5C × H05RR-F ▪ max. unreel load: 16 A max./11 040 W ▪ children protection: no ▪ packaging: 1 pc, packet 		

PM0905	1/-/-/1	
19 14 071 250	PM0905	
	 25 m	 H05RR-F 2.5 mm ²
<ul style="list-style-type: none"> ▪ length: 25 m ▪ conductor cross section: 2.5 mm² ▪ voltage: 400 V~ ▪ current: 16 A ▪ IP rating: IP44 ▪ number of sockets: 1 		
<ul style="list-style-type: none"> ▪ thermal fuse: no ▪ conductor: CGSG 5C × H05RR-F ▪ max. unreel load: 16 A max./11 040 W ▪ children protection: no ▪ packaging: 1 pc, packet 		

PM1102	1/-/-/2	
19 14 081 102	PM1102	
	 10 m	 H07RN-F 4.0 mm ²
<ul style="list-style-type: none"> ▪ length: 10 m ▪ conductor cross section: 4,0 mm² ▪ voltage: 400 V~ ▪ current: 32 A ▪ IP rating: IP44 ▪ number of sockets: 1 		
<ul style="list-style-type: none"> ▪ thermal fuse: no ▪ conductor: CGSG 5C × H07RN-F ▪ max. unreel load: 32 A max./22 000 W ▪ children protection: no ▪ packaging: 1 pc, packet 		

PM1103	1/-/-/1	
19 14 081 103	PM1103	
	 15 m	 H07RN-F 4.0 mm ²
<ul style="list-style-type: none"> ▪ length: 15 m ▪ conductor cross section: 4,0 mm² ▪ voltage: 400 V~ ▪ current: 32 A ▪ IP rating: IP44 ▪ number of sockets: 1 		
<ul style="list-style-type: none"> ▪ thermal fuse: no ▪ conductor: CGSG 5C × H07RN-F ▪ max. unreel load: 32 A max./22 000 W ▪ children protection: no ▪ packaging: 1 pc, packet 		

PM1104	1/-/-/1	
19 14 081 104	PM1104	
	 20 m	 H07RN-F 4.0 mm ²
<ul style="list-style-type: none"> ▪ length: 20 m ▪ conductor cross section: 4,0 mm² ▪ voltage: 400 V~ ▪ current: 32 A ▪ IP rating: IP44 ▪ number of sockets: 1 		
<ul style="list-style-type: none"> ▪ thermal fuse: no ▪ conductor: CGSG 5C × H07RN-F ▪ max. unreel load: 32 A max./22 000 W ▪ children protection: no ▪ packaging: 1 pc, packet 		

PM1105

1/-/-1

19 14 081 105

PM1105



8 592920 110096



- length: 25 m
- conductor cross section: 4,0 mm²
- voltage: 400 V~
- current: 32 A
- IP rating: IP44
- number of sockets: 1
- thermal fuse: no
- conductor: CGSG 5C × H07RN-F
- max. unreel load: 32 A max./22 000 W
- children protection: no
- packaging: 1 pc, packet

Cable reels

SCHUKO

3-phase rubber

- 3phase extension cable on reel with neoprene insulation
- immune to water (IP44), extreme temperatures and oils
- power extension cable reel with thermal fuse
- stable stand, reel and rubber-coated grip

length: 25 m = conductor cross section: 1.5 mm² = voltage: 230 V~/400 V~ = current: 13 A = IP rating: IP44 = number of sockets: 1 = thermal fuse = conductor: H07RN-F = max. reeled load: 230 V~: 4.35 A max./1 000 W; 400 V~: 6.25 A max./2 500 W = max. unreel load: 230 V~: 13 A max./3 000 W; 400 V~: 12.5 A max./5 000 W = children protection = packaging: 1 pc, box



8 592920 025062

P192250

1/-/-1

19 28 432 500

E-102A

length: 33 m = conductor cross section: 2.5 mm² = voltage: 230 V~/400 V~ = current: 15 A = IP rating: IP44 = number of sockets: 1 = thermal fuse = conductor: H07RN-F = max. reeled load: 230 V~: 6.52 A max./1 500 W; 400 V~: 6.25 A max./2 500 W = max. unreel load: 230 V~: 15.22 A max./3 500 W; 400 V~: 16 A max./6 400 W = children protection = packaging: 1 pc, box



8 592920 091654

P19733

1/-/-1

19 28 733 300

EM7-533 IP44
440V (E-017)

1-phase weatherproof PVC

- 1-phase extension cable on cable-reel, weather-proof insulation
- resistant to water (IP44), extreme temperatures and oils
- EMOS extension cable with thermal fuse
- stable stand, winding reel and rubberised handle

- length: 50 m
- conductor cross section: 1.5 mm²
- voltage: 230 V
- current: 16 A
- IP rating: IP44
- number of sockets: 4
- thermal fuse
- conductor: AT-N05V3V3-F
- max. reeled load: 4.8 A max./1 100 W

- max. unreeled load: 16 A max./3 680 W
- children protection: no
- other functions: guiding loop, cable reel brake
- packaging: 1 pc, box



P08650W

1/-/-1

19 28 745 000

P08650W

- length: 25 m
- conductor cross section: 1.5 mm²
- voltage: 230 V
- current: 16 A
- IP rating: IP44
- number of sockets: 4
- thermal fuse
- conductor: AT-N05V3V3-F
- max. reeled load: 4.8 A max./1 100 W

- max. unreeled load: 16 A max./3 680 W
- children protection: no
- other functions: guiding loop, cable reel brake
- packaging: 1 pc, box



P08625W

1/-/-1

19 28 742 500

P08625W

- length: 20 m
- conductor cross section: 1.5 mm²
- voltage: 230 V
- current: 13 A
- IP rating: IP44
- number of sockets: 3
- thermal fuse
- conductor: AT-N05V3V3-F
- max. reeled load: 4.35 A max./1 000 W

- max. unreeled load: 13.04 A max./3 000 W
- children protection: no
- other functions: 2× USB-A Σ 2.1 A max.
- packaging: 1 pc, box



P08620W

1/-/-1

19 28 732 000

P08620W

1-phase rubber

- 1phase extension cable on reel w/ neoprene/rubber insulation
- immune to water (IP44), extreme temperatures and oils
- power extension cable reel with thermal fuse
- stable stand, reel and rubber-coated grip

- length: 15 m
- conductor cross section: 1.5 mm²
- voltage: 230 V
- current: 13 A
- IP rating: IP44
- number of sockets: 4
- thermal fuse
- conductor: H07RN-F
- max. reeled load: 4.35 A max./1 000 W

- max. unreeled load: 13.04 A max./3 000 W
- children protection: no
- other functions: LED reflect. 20 W/1 600 lm/6 500 K
- packaging: 1 pc, box

**P08215**

1/-/-1

19 28 441 500

P08215

- length: 25 m
- conductor cross section: 1.5 mm²
- voltage: 230 V
- current: 16 A
- IP rating: IP44
- number of sockets: 4
- thermal fuse
- conductor: H07RN-F
- max. reeled load: 4.35 A max./1 000 W

- max. unreeled load: 16 A max./3 680 W
- children protection: no
- other functions: guiding loop, cable reel brake
- packaging: 1 pc, box

**P19222**

1/-/-1

19 28 242 502

P19222

- length: 40 m
- conductor cross section: 2.5 mm²
- voltage: 230 V
- current: 16 A
- IP rating: IP44
- number of sockets: 4
- thermal fuse
- conductor: H07RN-F
- max. reeled load: 5.2 A max./1 200 W

- max. unreeled load: 16 A max./3 680 W
- children protection: no
- other functions: guiding loop, cable reel brake
- packaging: 1 pc, box

**P19224**

1/-/-1

19 28 544 000

P19224

- length: 50 m
- conductor cross section: 1.5 mm²
- voltage: 230 V
- current: 16 A
- IP rating: IP44
- number of sockets: 4
- thermal fuse
- conductor: H07RN-F
- max. reeled load: 4.35 A max./1 000 W

- max. unreeled load: 16 A max./3 680 W
- children protection: no
- other functions: guiding loop, cable reel brake
- packaging: 1 pc, box

**P19223**

1/-/-1

19 28 245 003

P19223



- length: 50 m
- conductor cross section: 2.5 mm²
- voltage: 230 V
- current: 15 A
- IP rating: IP44
- number of sockets: 4
- thermal fuse
- conductor: H07RN-F
- max. reeled load: 6.52 A max./1 500 W

- max. unreeled load: 15.22 A max./3 500 W
- children protection
- packaging: 1 pc, box



P19220 1/-/-1
19 28 545 001 E-017

- length: 50 m
- conductor cross section: 2.5 mm²
- voltage: 230 V
- current: 15 A
- IP rating: IP44
- number of sockets: 4
- thermal fuse
- conductor: H05RR-F
- max. reeled load: 6.52 A max./1 500 W

- max. unreeled load: 15.22 A max./3 500 W
- children protection
- packaging: 1 pc, box



P19221 1/-/-1
19 28 545 011 E-017

- length: 25 m
- conductor cross section: 1.5 mm²
- voltage: 230 V
- current: 16 A
- IP rating: IP44
- number of sockets: 4
- thermal fuse
- conductor: H05RR-F3G
- max. reeled load: 4.8 A max./1 100 W

- max. unreeled load: 16 A max./3 680 W
- children protection
- packaging: 1 pc, box



P08225 1/-/-1
19 28 242 500 E-10P

- length: 50 m
- conductor cross section: 1.5 mm²
- voltage: 230 V
- current: 16 A
- IP rating: IP44
- number of sockets: 4
- thermal fuse
- conductor: H05RR-F3G
- max. reeled load: 4.8 A max./1 100 W

- max. unreeled load: 16 A max./3 680 W
- children protection
- packaging: 1 pc, box



P08250 1/-/-1
19 28 245 000 E-10DP

- length: 25 m
- conductor cross section: 2.5 mm²
- voltage: 230 V
- current: 16 A
- IP rating: IP44
- number of sockets: 4
- thermal fuse
- conductor: H05RR-F3G
- max. reeled load: 6 A max./1 600 W

- max. unreeled load: 16 A max./3 680 W
- children protection
- packaging: 1 pc, box



P19625 1/-/-1
19 28 542 500 E-10P

1-phase PVC

- 1phase extension cable on reel with PVC insulation
- stable stand, reel and rubber-coated grip
- power extension cable reel with thermal fuse
- some also with backlit switch and guide loop (for reeling)

- length: 25 m
- conductor cross section: 1.5 mm²
- voltage: 230 V
- current: 13 A
- IP rating: IP20
- number of sockets: 4
- thermal fuse
- conductor: H05VV-F3G
- max. reeled load: 4.35 A max./1 000 W

- max. unreeled load: 13 A max./3 000 W
- children protection
- other functions: guiding loop, cable reel brake, switch
- packaging: 1 pc, box



P19427 1/-/-1
19 28 042 507 HJR-4BA



- length: 25 m
- conductor cross section: 1.5 mm²
- voltage: 230 V
- current: 16 A
- IP rating: IP20
- number of sockets: 4
- thermal fuse
- conductor: H05VV-F3G
- max. reeled load: 4.8 A max./1 100 W

- max. unreeled load: 16 A max./3 680 W
- children protection: no
- packaging: 1 pc, box



P092251 1/-/-1
19 28 042 504 P092251



- length: 50 m
- conductor cross section: 1.5 mm²
- voltage: 230 V
- current: 16 A
- IP rating: IP20
- number of sockets: 4
- thermal fuse
- conductor: H05VV-F3G
- max. reeled load: 4.8 A max./1 100 W

- max. unreeled load: 16 A max./3 680 W
- children protection: no
- other functions: guiding loop, cable reel brake, switch
- packaging: 1 pc, box



P092501 1/-/-1
19 28 045 003 P092501



- length: 25 m
- conductor cross section: 2.5 mm²
- voltage: 230 V
- current: 16 A
- IP rating: IP20
- number of sockets: 4
- thermal fuse
- conductor: H05VV-F3G
- max. reeled load: 6 A max./1 600 W

- max. unreeled load: 16 A max./3 600 W
- children protection
- packaging: 1 pc, box



P09225M 1/-/-1
19 28 042 501 E-4





- length: 40 m
- conductor cross section: 2.5 mm²
- voltage: 230 V
- current: 16 A
- IP rating: IP20
- number of sockets: 4
- thermal fuse
- conductor: H05VV-F3G
- max. reeled load: 6 A max./1 380 W

- max. unreeled load: 16 A max./3 600 W
- children protection
- packaging: 1 pc, box



P09240M

1/-/-/1

19 28 044 001

E-4

- length: 25 m
- conductor cross section: 1.5 mm²
- voltage: 230 V
- current: 16 A
- IP rating: IP20
- number of sockets: 4
- thermal fuse
- conductor: H05VV-F3G
- max. reeled load: 4.8 A max./1 100 W

- max. unreeled load: 16 A max./3 600 W
- children protection: no
- packaging: 1 pc, box



P09225

1/-/-/1

19 28 042 500

DG-4ZR-DB04
(HJR-4A)

- length: 40 m
- conductor cross section: 1.5 mm²
- voltage: 230 V
- current: 16 A
- IP rating: IP20
- number of sockets: 4
- thermal fuse
- conductor: H05VV-F
- max. reeled load: 4.8 A max./1 100 W

- max. unreeled load: 16 A max./3 600 W
- children protection: no
- packaging: 1 pc, box



P09240

1/-/-/1

19 28 044 000

E-4

- length: 50 m
- conductor cross section: 1.5 mm²
- voltage: 230 V
- current: 16 A
- IP rating: IP20
- number of sockets: 4
- thermal fuse
- conductor: H05VV-F3G
- max. reeled load: 4.8 A max./1 100 W

- max. unreeled load: 16 A max./3 600 W
- children protection: no
- packaging: 1 pc, box



P09250

1/-/-/1

19 28 045 000

DG-4ZR-DB04
(HJR-4)

- length: 20 m
- conductor cross section: 1.0 mm²
- voltage: 230 V
- current: 10 A
- IP rating: IP20
- number of sockets: 4
- thermal fuse
- conductor: H05VV-F3G
- max. reeled load: 4.8 A max./1 100 W

- max. unreeled load: 10 A max./2 300 W
- children protection: no
- packaging: 1 pc, box



P09220

1/-/-/1

19 28 142 000

DG-4ZR-DB04
(HJR-4AC)

- length: 15 m
- conductor cross section: 1.0 mm²
- voltage: 230 V
- current: 10 A
- IP rating: IP20
- number of sockets: 4
- thermal fuse
- conductor: H05VV-F3G
- max. reeled load: 4 A max./920 W

- max. unreeled load: 10 A max./2 300 W
- children protection: no
- packaging: 1 pc, box



P19515 1/-/-2
19 28 141 500 E-4ZR-15M-D04

- length: 10 m
- conductor cross section: 1.0 mm²
- voltage: 230 V
- current: 10 A
- IP rating: IP20
- number of sockets: 4
- thermal fuse
- conductor: H05VV-F3G
- max. reeled load: 4 A max./920 W

- max. unreeled load: 10 A max./2 300 W
- children protection: no
- packaging: 1 pc, box



P19510 1/-/-6
19 28 141 000 P19510(E-XD04)

Sockets, plugs, adaptors, timers, others

Holders

- extension cable holder, allows fixing to a wall
- in version for 3–4 or 5–6 sockets
- from thin white plastic that visually blends into the wall

P0003C

1/5/20/80

19 04 030 000

P3



- product: holder for sockets of extension
- material: plastic
- packaging: 1 pc, hanging



P0004C

1/-/20/80

19 04 040 000

P0004C







- product: holder for sockets of extension
- material: plastic
- packaging: 1 pc, hanging



Plugs, sockets





- accessories for assembling an extension cable
- enclosure: IP20, IP44 or IP65 and max. current load: 16 A
- straight or thin angle plugs – allow furniture close to wall
- many with loop for hanging (cable kept off the ground)
- sockets also fitted with child covers

P0047 1/5/-/200
19 26 010 100 EM-GBYC-01





- product: socket for the flexible cord – st
- voltage/current: 250 V~/16 A max.
- children protection
- IP rating: IP20
- material: plastic
- packaging: 1 pc, hanging

P0066 1/10/-/100
19 06 100 090 E-GRC-03





- product: ultra thin fork for the flexible c
- voltage/current: 250 V~/16 A max.
- maximum load: 3 680 W
- IP rating: IP20
- material: plastic
- packaging: 1 pc, hanging

P0039 1/10/-/280
19 06 100 050 EM-GRC-02





- product: plug for the flexible cord, angul
- voltage/current: 250 V~/16 A max.
- maximum load: 3 680 W
- IP rating: IP20
- material: plastic
- packaging: 1 pc, hanging

P0038 1/5/-/200
19 06 110 300 EM-GRC-01





- product: plug for the flexible cord, straig
- voltage/current: 250 V~/16 A max.
- maximum load: 3 680 W
- IP rating: IP20
- material: plastic
- packaging: 1 pc, hanging

P0034 1/5/-/150
19 06 110 200 YC-FA-4Z





- product: plug for the flexible cord, straig
- voltage/current: 250 V~/16 A max.
- maximum load: 3 680 W
- IP rating: IP20
- material: plastic
- packaging: 1 pc, hanging

P0049 1/5/30/60
19 26 010 200 YC-DA-14





- product: the gum socket for the flexible
- voltage/current: 250 V~/16 A max.
- children protection
- IP rating: IP44
- material: rubber
- packaging: 1 pc, hanging

P0050 1/5/20/80
19 06 100 060 YC-DA-14Z

- product: the gum fork for the flexible co
- voltage/current: 250 V~/16 A max.
- maximum load: 3 680 W
- IP rating: IP44
- material: rubber
- packaging: 1 pc, hanging

P0072 1/-/6/36
19 05 010 003 P0072

- product: USB socket
- voltage/current: 250 V~/16 A max.
- children protection
- IP rating: IP20
- material: plastic
- packaging: 1 pc, hanging

Adaptors

- splitter sockets with 1–4 outlets, fitted with child covers
- enable connecting multiple devices into one socket
- max. load 2 300 or 3 680 W, IP20 enclosure
- for connecting devices with round or flat plugs
- with or without switch

P00242

1/4/-/200

19 25 030 020

KF-Z-01/03A



8 595025 325013



- product: adapter plug 3×
- voltage/current: 250 V~/10 A max.
- IP rating: IP20
- material: plastic
- packaging: 1 pc, hanging

P0063

1/5/-/30

19 05 120 010

ES-01/02K



8 592920 036907

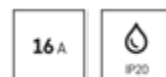

- product: adapter plug 2× with switch
- voltage/current: 250 V~/16 A max.
- maximum load: 3 680 W
- children protection
- IP rating: IP20
- material: plastic
- packaging: 1 pc, hanging

P00252

1/5/40/80

19 25 030 030

ODL-158



8 595025 390790



- product: adapter plug 2×
- voltage/current: 250 V~/10 A max.
- children protection
- IP rating: IP20
- material: plastic
- packaging: 1 pc, hanging

P00262

1/5/80/160

19 25 030 040

P00262 (GES-058)



8 595025 390820



- product: socket with switch
- voltage/current: 250 V~/16 A max.
- children protection
- IP rating: IP20
- material: plastic
- packaging: 1 pc, hanging

P00272

1/4/-/60

19 25 030 050

P00272 (GES-073)



8 595025 390851



- product: adapter plug 3×
- voltage/current: 250 V~/16 A max.
- children protection
- IP rating: IP20
- material: plastic
- packaging: 1 pc, hanging

P00282

1/5/-/80

19 25 030 060

P00282 (GES-098)



8 595025 390882



- product: adapter plug 3× with switch
- voltage/current: 250 V~/16 A max.
- children protection
- IP rating: IP20
- material: plastic
- packaging: 1 pc, hanging

P00292

1/-/4/40

19 25 030 090

P00292



8 592920 078242



- product: socket with switch
- voltage/current: 250 V~/16 A max.
- children protection
- IP rating: IP44
- material: plastic
- packaging: 1 pc, hanging

Travel adaptors

- travel aid for connecting to FRENCH and SCHUKO sockets
- often in the form of universal adapter w/ min. 5 plug types
- can be used in more than 150 world countries
- also with adapter w/ SCHUKO socket (used in DE, HU, SI etc.)
- max. current load of 10 or 16 A

- designed for: for Europeans travelling abroad
- using: America, Asia, Australia, New Zealand, China,
- packaging: 1 pc, small box



8 592920 120897

P0056N

19 10 000 900

1/-/-/20

1.103145

- designed for: for foreigners arriving in Europe and h
- using: plugs (USA, GB, JP, CN, AU etc.) into the SCH
- packaging: 1 pc, small box



8 592920 076323

P0055N

19 10 000 800

1/-/-/50

WORLD TO
EUROPE 2.0

Timers

- socket with timer automatically turns appliance on/off
- ideal for aquariums, terrariums, pool pumps and lighting
- mechanical timer sockets or more practical digital timers
- digital timer to plan out your week using 8–20 programmes
- can handle a max. load of 3 680 W

- type: digital
- voltage/current: 230 V~/16 A max.
- maximum load: 3 680 W
- minimal time setting: 1 minute
- option of manual switch-on
- number of programs: 8
- number of switching per day: 8
- function to change summer/winter time
- IP rating: IP20

▪ packaging: 1 pc, box



8 592920 117880

P5521N

19 27 110 012

1/-/4/16

TS-ED1

- type: mechanical
- voltage/current: 230 V~/16 A max.
- maximum load: 3 680 W
- minimal time setting: 30 minutes
- option of manual switch-on
- number of switching per day: 48
- IP rating: IP20
- packaging: 1 pc, box



P5523N
19 27 010 023

1/-/4/16
15GD-3A-1

- type: mechanical
- outdoor using
- voltage/current: 230 V~/16 A max.
- maximum load: 3 680 W
- minimal time setting: 30 minutes
- option of manual switch-on: no
- number of switching per day: 48
- IP rating: IP44
- packaging: 1 pc, box



P5526N
19 27 110 033

1/-/4/16
EMT450

- type: mechanical
- voltage/current: 230 V~/16 A max.
- maximum load: 3 680 W
- minimal time setting: 15 minutes
- option of manual switch-on
- number of switching per day: 96
- IP rating: IP20
- packaging: 1 pc, box



P5522
19 27 010 010

1/-/4/16
1E/2A

3 680 W
max.



- type: digital
- outdoor using
- voltage/current: 230 V~/16 A max.
- maximum load: 3 680 W
- minimal time setting: 1 minute
- option of manual switch-on
- number of programs: 10
- number of switching per day: 10
- function to change summer/winter time

- IP rating: IP44
- packaging: 1 pc, box



P5525
19 27 110 020

1/-/4/12
TGE-5B (TGE-5)

3 680 W
max.



- product: remote-controlled sockets, 2 sockets + 1×
- voltage/current: 250 V~/13 A max.
- maximum load: 3 000 W
- children protection
- IP rating: IP44
- material: plastic
- remote control: power supply 1× 3 V CR2032 (inclu)
- packaging: 1 pc, small box



P0068
19 05 111 001

1/-/-/18
52023+50074

3 000 W
max.



- product: remote-controlled sockets, 3 sockets + 1x
- voltage/current: 230 V~/4.35 A max.
- maximum load: 1 000 W
- children protection
- IP rating: IP20
- material: plastic
- number of positions: 2P + PE
- remote control: power supply 1x 3 V CR2032 (inclu)
- packaging: 1 pc, small box



P0069

1/-/3/18

19 05 120 030

P0064

Energy consumption meters

- socket-powered wattmeter to measure appliance's consumption
- helps reduce expenses for electricity
- max. load 3 680 W
- displays: voltage, current, active power and power factor
- also fitted with child covers

- maximum load: 3 680 W
- voltage/current: 230 V~/16 A max.
- measuring range: 2 W-3 680 W
- range of power consumption: 0 kWh-9 999 kWh
- dimensions: 150 × 75 × 75 mm
- packaging: 1 pc, box



P5822

1/2/-/16

19 31 000 020

P5822

GoSmart sockets

- Remote on/off switching of connected appliances
- Overview of electricity consumption of connected appliances
- Schedule creation and automatic ON/OFF settings
- Setting up delayed shutdown of appliances
- Network connection via WIFI or Bluetooth protocols
- Compatibility with EMOS GoSmart products and TUYA devices
- Voice control with Google Assistant and Amazon Alexa

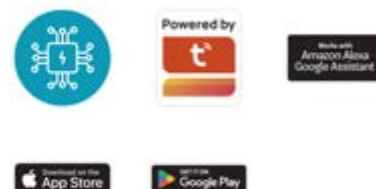

- product: Wi-Fi socket
- maximum load: 3 680 W
- voltage/current: 230 V~/16 A max.
- transmission frequency: 2.4 GHz WIFI
- children protection
- supported OS: Android, iOS
- compatibility: EMOS GoSmart, TUYA, LIDL, Smartlife
- protocol: Wi-Fi
- control by voice assistants

▪ notifications to the mobile app



P5531

1/-/3/2

19 36 055 310

IP-3002S

- product: Wi-Fi timer/wattmeter-outside
- maximum load: 3 680 W
- voltage/current: 230 V~/16 A max.
- transmission frequency: 2,4 GHz
- children protection
- supported OS: Android, iOS
- compatibility: EMOS GoSmart, TUYA, LIDL, Smartlife
- protocol: Wi-Fi
- control by voice assistants
- notifications to the mobile app



P5532 1/-/-/30
19 36 055 320 IP-3006S

- product: ZigBee socket
- maximum load: 3 680 W
- voltage/current: 230 V~/16 A max.
- transmission frequency: 2,4 GHz
- children protection
- supported OS: Android, iOS
- compatibility: EMOS GoSmart, TUYA, LIDL, Smartlife
- protocol: Zigbee 3.0
- control by voice assistants
- notifications to the mobile app



P5533 1/-/-/32
19 36 553 300 IP-3009S

- product: ZigBee socket
- maximum load: 3 680 W
- voltage/current: 230 V~/16 A max.
- transmission frequency: 2,4 GHz
- children protection
- supported OS: Android, iOS
- compatibility: EMOS GoSmart, TUYA, LIDL, Smartlife
- protocol: Zigbee 3.0
- control by voice assistants
- notifications to the mobile app



P5534 1/-/-/30
19 36 553 400 IP-3010S

Industrial plugs, 380 V sockets

- wall-mounted industrial plugs and sockets
- with max. current load of 16 or 32 A
- body made of plastic, screw terminals or screw-free design
- 3 phases, voltage 380–415 V, 4–5 poles

A6210 1/-/10/40
31 06 213 240 513.1656



- product: wall socket
- voltage/current: 380–415 V~/16 A
- IP rating: IP44
- material: plastic
- number of positions: 4
- packaging: no packaging



A6212 1/-/-/10
31 06 213 242 513.3256



- product: wall socket
- voltage/current: 380–415 V~/32 A
- IP rating: IP44
- material: plastic
- number of positions: 4
- packaging: no packaging



A6211 1/-/10/40
31 06 213 241 513.1657



- product: wall socket
- voltage/current: 380–415 V~/16 A
- IP rating: IP44
- material: plastic
- number of positions: 5
- packaging: no packaging



A6213 1/-/10
31 06 213 243 513.3257



- product: wall socket
- voltage/current: 380–415 V~/32 A
- IP rating: IP44
- material: plastic
- number of positions: 5
- packaging: no packaging



A6310 1/-/10/50
31 06 213 150 313.1646



- product: coupler
- voltage/current: 380–415 V~/16 A
- IP rating: IP44
- material: plastic
- number of positions: 4
- packaging: no packaging



A6312 1/-/10/40
31 06 213 152 313.3246



- product: coupler
- voltage/current: 380–415 V~/32 A
- IP rating: IP44
- material: plastic
- number of positions: 4
- packaging: no packaging



A6311 1/-/10/50
31 06 213 151 313.1647



- product: coupler
- voltage/current: 380–415 V~/16 A
- IP rating: IP44
- material: plastic
- number of positions: 5
- packaging: no packaging



A6313 1/-/10/40
31 06 213 153 313.3247



- product: coupler
- voltage/current: 380–415 V~/32 A
- IP rating: IP44
- material: plastic
- number of positions: 5
- packaging: no packaging



A6110 1/-/10/50
31 05 213 050 213.1636



- product: separate plug
- voltage/current: 380–415 V~/16 A
- IP rating: IP44
- material: plastic
- number of positions: 4
- packaging: no packaging



A6114 1/-/10/40
31 05 213 054 213.3236



- product: separate plug
- voltage/current: 380–415 V~/32 A
- IP rating: IP44
- material: plastic
- number of positions: 4
- packaging: no packaging



A6111 1/-/10/50
31 05 213 051 213.1637



- product: separate plug
- voltage/current: 380–415 V~/16 A
- IP rating: IP44
- material: plastic
- number of positions: 5
- packaging: no packaging



A6115 1/-/10/40
31 05 213 055 213.3237



- product: separate plug
- voltage/current: 380–415 V~/32 A
- IP rating: IP44
- material: plastic
- number of positions: 5
- packaging: no packaging



Flexo, assembled cords

Rubber



Two-cores

- rubber two-strand mobile cord with fixed-mount plug
- length 3 or 5 m, various cross sections, black

S03030 1/5/-/20
24 21 130 212 SY-10 (YC-B-2ZA, LA016A)



8 595025 348838



- conductor: H05RR-F
- length: 3 m
- type of insulation: rubber
- colour: black
- conductor cross section: 2× 1.0 mm²
- type: SY-10

▪ packaging: 1 pc, hanging

S03050 1/5/-/20
24 21 150 212 SY-10 (YC-B-2ZA, LA016A)



8 595025 348845



- conductor: H05RR-F
- length: 5 m
- type of insulation: rubber
- colour: black
- conductor cross section: 2× 1.0 mm²
- type: SY-10

▪ packaging: 1 pc, hanging

S03330 1/5/-/20
24 21 230 230 SY-10 (YC-B-2ZA, LA016A)



8 595025 382757



- conductor: H05RR-F
- length: 3 m
- type of insulation: rubber
- colour: black
- conductor cross section: 2× 1.5 mm²
- type: SY-10

▪ packaging: 1 pc, hanging

S03350 1/5/-/20
24 21 250 230 SY-10 (YC-B-2ZA, LA016A)



8 595025 382764



- conductor: H05RR-F
- length: 5 m
- type of insulation: rubber
- colour: black
- conductor cross section: 2× 1.5 mm²
- type: SY-10

▪ packaging: 1 pc, hanging

S03030N 1/5/-/20
24 21 130 213 S03030N



8 592920 130865



- conductor: H05RN-F
- length: 3 m
- type of insulation: rubber/neopren
- colour: black
- conductor cross section: 2× 1.0 mm²
- type: SY-10

▪ packaging: 1 pc, hanging

S03031N 1/5/-/20
24 21 130 214 S03031N



8 592920 130926

- conductor: H07RN-F
- length: 3 m
- type of insulation: rubber/neopren
- colour: black
- conductor cross section: 2× 1.0 mm²
- type: SY-10

▪ packaging: 1 pc, hanging

S03050N

1/5/-/20

24 21 150 213

S03050N

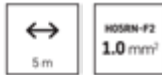

- conductor: H05RN-F
- length: 5 m
- type of insulation: rubber/neopren
- colour: black
- conductor cross section: 2× 1.0 mm²
- type: SY-10
- packaging: 1 pc, hanging

Three-cores

- rubber three-strand mobile cord with fixed-mount plug
- length 3 or 5 m, various cross sections, black

S03130

1/-/5/15

24 25 130 220

SY-11 (GEP-003,
LA017D)

- conductor: H05RR-F
- length: 3 m
- type of insulation: rubber
- colour: black
- conductor cross section: 3× 1.0 mm²
- type: SY-11
- packaging: 1 pc, hanging

S03150

1/5/-/15

24 25 150 220

SY-11 (GEP-003,
LA017D)

- conductor: H05RR-F
- length: 5 m
- type of insulation: rubber
- colour: black
- conductor cross section: 3× 1.0 mm²
- type: SY-11
- packaging: 1 pc, hanging

S03230

1/-/5/25

24 25 230 220

SY-11 (GEP-003,
LA017D)

- conductor: H05RR-F
- length: 3 m
- type of insulation: rubber
- colour: black
- conductor cross section: 3× 1.5 mm²
- type: SY-11
- packaging: 1 pc, hanging

S03250

1/5/-/10

24 25 250 220

SY-11 (GEP-003,
LA017D)

- conductor: H05RR-F
- length: 5 m
- type of insulation: rubber
- colour: black
- conductor cross section: 3× 1.5 mm²
- type: SY-11
- packaging: 1 pc, hanging

S03430

1/-/5/10

24 25 430 230

SY-11 (GEP-003,
LA017D)

- conductor: H05RR-F
- length: 3 m
- type of insulation: rubber
- colour: black
- conductor cross section: 3× 2.5 mm²
- type: SY-11
- packaging: 1 pc, hanging

S03450

1/-/5/10

24 25 450 230

SY-11 (GEP-003,
LA017D)

- conductor: H05RR-F
- length: 5 m
- type of insulation: rubber
- colour: black
- conductor cross section: 3× 2.5 mm²
- type: SY-11
- packaging: 1 pc, hanging



S00003 1/5/-/30
24 35 724 032
KF-CR1-H05RR-F3G0.75MM2









- conductor: H05RR-F
- length: 2.4 m
- type of insulation: braided/rubber
- colour: white
- conductor cross section: 3× 0.75 mm²
- type: KF-CR1-H05RR-F

packaging: 1 pc, hanging





S03130N 1/-/5/15
24 25 130 210
S03130N

- conductor: H05RN-F
- length: 3 m
- type of insulation: rubber/neopren
- colour: black
- conductor cross section: 3× 1.0 mm²
- type: SY-11

packaging: 1 pc, hanging





S03150N 1/5/-/15
24 25 150 210
S03150N

- conductor: H05RN-F
- length: 5 m
- type of insulation: rubber/neopren
- colour: black
- conductor cross section: 3× 1.0 mm²
- type: SY-11

packaging: 1 pc, hanging





S03210N 1/-/-/6
24 25 210 210
S03210N

- conductor: H07RN-F
- length: 10 m
- type of insulation: rubber/neopren
- colour: black
- conductor cross section: 3× 1.5 mm²
- type: SY-11

packaging: 1 pc, hanging





S03230N 1/-/5/15
24 25 230 210
S03230N

- conductor: H07RN-F
- length: 3 m
- type of insulation: rubber/neopren
- colour: black
- conductor cross section: 3× 1.5 mm²
- type: SY-11

packaging: 1 pc, hanging

S03250N 1/5/-/10
24 25 250 210
S03250N

- conductor: H07RN-F
- length: 5 m
- type of insulation: rubber/neopren
- colour: black
- conductor cross section: 3× 1.5 mm²
- type: SY-11





packaging: 1 pc, hanging





Flexo, assembled cords





PVC





Two-cores





- PVC two-strand mobile cord with fixed-mount plug
- black or white
- length 2, 3 or 5 m, various cross sections
- selected models fitted with switch





S12252	1/5/30/60	
24 01 520 132	HY020-F	
	 	
<ul style="list-style-type: none"> ▪ conductor: H03VVH2-F ▪ length: 2 m ▪ type of insulation: PVC ▪ colour: white ▪ conductor cross section: 2× 0.5 mm² ▪ type: KF-H1 (HY020-F) 		
		▪ packaging: 1 pc, hanging

S15272	1/5/35/70	
24 01 720 132	HY020-F	
	 	
<ul style="list-style-type: none"> ▪ conductor: H03VVH2-F ▪ length: 2 m ▪ type of insulation: PVC ▪ colour: white ▪ conductor cross section: 2× 0.75 mm² ▪ type: KF-H1 (HY020-F) 		
		▪ packaging: 1 pc, hanging



S15273	1/5/30/60	
24 01 730 132	HY020-F	
	 	
<ul style="list-style-type: none"> ▪ conductor: H03VVH2-F ▪ length: 3 m ▪ type of insulation: PVC ▪ colour: white ▪ conductor cross section: 2× 0.75 mm² ▪ type: KF-H1 (HY020-F) 		
		▪ packaging: 1 pc, hanging

S15275	1/5/-/30	
24 01 750 132	HY020-F	
	 	
<ul style="list-style-type: none"> ▪ conductor: H03VVH2-F ▪ length: 5 m ▪ type of insulation: PVC ▪ colour: white ▪ conductor cross section: 2× 0.75 mm² ▪ type: KF-H1 (HY020-F) 		
		▪ packaging: 1 pc, hanging

S19272	1/5/35/70	
24 01 720 232	HY020-F	
	 	
<ul style="list-style-type: none"> ▪ conductor: H03VVH2-F ▪ length: 2 m ▪ type of insulation: PVC ▪ colour: black ▪ conductor cross section: 2× 0.75 mm² ▪ type: KF-H1 (HY020-F) 		
		▪ packaging: 1 pc, hanging

S19273	1/5/30/60	
24 01 730 232	HY020-F	
	 	
<ul style="list-style-type: none"> ▪ conductor: H03VVH2-F ▪ length: 3 m ▪ type of insulation: PVC ▪ colour: black ▪ conductor cross section: 2× 0.75 mm² ▪ type: KF-H1 (HY020-F) 		
		▪ packaging: 1 pc, hanging



S19275 1/5/-/30
24 01 750 232 HY020-F

- conductor: H03VVH2-F
- length: 5 m
- type of insulation: PVC
- colour: black
- conductor cross section: 2× 0.75 mm²
- type: KF-H1 (HY020-F)

▪ packaging: 1 pc, hanging



S08272 1/5/30/60
24 02 720 132 KF-H1/S051E4

- conductor: H03VVH2-F
- length: 2 m
- type of insulation: PVC
- colour: white
- conductor cross section: 2× 0.75 mm²
- type: KF-H1/S051E4

▪ packaging: 1 pc, hanging



S08273 1/5/25/50
24 02 730 132 KF-H1/S051E4

- conductor: H03VVH2-F
- length: 3 m
- type of insulation: PVC
- colour: white
- conductor cross section: 2× 0.75 mm²
- type: KF-H1/S051E4

▪ packaging: 1 pc, hanging



S09272 1/5/25/50
24 02 720 232 KF-H1/S051E4

- conductor: H03VVH2-F
- length: 2 m
- type of insulation: PVC
- colour: black
- conductor cross section: 2× 0.75 mm²
- type: KF-H1/S051E4

▪ packaging: 1 pc, hanging



S09273 1/5/25/50
24 02 730 232 KF-H1/S051E4

- conductor: H03VVH2-F
- length: 3 m
- type of insulation: PVC
- colour: black
- conductor cross section: 2× 0.75 mm²
- type: KF-H1/S051E4

▪ packaging: 1 pc, hanging

S1111 1/5/35/70
24 00 517 252 KF-Y11-1(LY-21/LY-22)



- conductor: H03VVH2-F
- length: 1.75 m
- type of insulation: PVC
- colour: black
- conductor cross section: 2× 0.5 mm²
- type: KF-Y11-1

▪ packaging: 1 pc, hanging

Three-cores

- PVC three-strand mobile cord with fixed-mount plug
- black or white
- length 2, 3 or 5 m, various cross sections



S14372 1/5/-/40
24 13 720 132 KF-CR2 (HY005-F)

- conductor: H05VV-F 3G
- length: 2 m
- type of insulation: PVC
- colour: white
- conductor cross section: 3× 0.75 mm²
- type: KF-CR2 (HY005-F)

▪ packaging: 1 pc, hanging

S14373 1/5/-/30
24 13 730 132 KF-CR2 (HY005-F)





- conductor: H05VV-F 3G
- length: 3 m
- type of insulation: PVC
- colour: white
- conductor cross section: 3× 0.75 mm²
- type: KF-CR2 (HY005-F)



▪ packaging: 1 pc, hanging

S14375 1/5/-/25

24 13 750 132 KF-CR2 (HY005-F)



8 595025 314390





- conductor: H05VV-F 3G
- length: 5 m
- type of insulation: PVC
- colour: white
- conductor cross section: 3× 0.75 mm²
- type: KF-CR2 (HY005-F)



= packaging: 1 pc, hanging

S14312 1/5/-/35

24 13 120 132 KF-CR2 (HY005-F)



8 595025 314314





- conductor: H05VV-F 3G
- length: 2 m
- type of insulation: PVC
- colour: white
- conductor cross section: 3× 1.0 mm²
- type: KF-CR2 (HY005-F)



= packaging: 1 pc, hanging

S14313 1/5/-/30

24 13 130 132 KF-CR2 (HY005-F)



8 595025 314321





- conductor: H05VV-F 3G
- length: 3 m
- type of insulation: PVC
- colour: white
- conductor cross section: 3× 1.0 mm²
- type: KF-CR2 (HY005-F)



= packaging: 1 pc, hanging

S14315 1/5/-/20

24 13 150 132 KF-CR2 (HY005-F)



8 595025 314338





- conductor: H05VV-F 3G
- length: 5 m
- type of insulation: PVC
- colour: white
- conductor cross section: 3× 1.0 mm²
- type: KF-CR2 (HY005-F)



= packaging: 1 pc, hanging

S14322 1/5/-/35

24 13 220 132 KF-CR2 (HY005-F)



8 595025 314345





- conductor: H05VV-F 3G
- length: 2 m
- type of insulation: PVC
- colour: white
- conductor cross section: 3× 1.5 mm²
- type: KF-CR2 (HY005-F)



= packaging: 1 pc, hanging

S14323 1/5/-/30

24 13 230 132 KF-CR2 (HY005-F)



8 595025 314352





- conductor: H05VV-F 3G
- length: 3 m
- type of insulation: PVC
- colour: white
- conductor cross section: 3× 1.5 mm²
- type: KF-CR2 (HY005-F)



= packaging: 1 pc, hanging

S14325 1/5/-/20

24 13 250 132 KF-CR2 (HY005-F)



8 595025 314369





- conductor: H05VV-F 3G
- length: 5 m
- type of insulation: PVC
- colour: white
- conductor cross section: 3× 1.5 mm²
- type: KF-CR2 (HY005-F)



= packaging: 1 pc, hanging

S18372 1/5/-/40

24 13 720 232 KF-CR2 (HY005-F)



8 595025 318640





- conductor: H05VV-F 3G
- length: 2 m
- type of insulation: PVC
- colour: black
- conductor cross section: 3× 0.75 mm²
- type: KF-CR2 (HY005-F)



= packaging: 1 pc, hanging

S18373 1/5/-/35

24 13 730 232 KF-CR2 (HY005-F)



8 595025 318657





- conductor: H05VV-F 3G
- length: 3 m
- type of insulation: PVC
- colour: black
- conductor cross section: 3× 0.75 mm²
- type: KF-CR2 (HY005-F)



= packaging: 1 pc, hanging

S18312 1/5/-/40

24 13 120 232 KF-CR2 (HY005-F)



8 595025 318671

- conductor: H05VV-F 3G
- length: 2 m
- type of insulation: PVC
- colour: black
- conductor cross section: 3× 1.0 mm²
- type: KF-CR2 (HY005-F)

= packaging: 1 pc, hanging





S18313 1/5/-/35

24 13 130 232 KF-CR2 (HY005-F)



8 595025 318688





- conductor: H05VV-F 3G
- length: 3 m
- type of insulation: PVC
- colour: black
- conductor cross section: 3× 1.0 mm²
- type: KF-CR2 (HY005-F)



packaging: 1 pc, hanging

S18315 1/5/-/20

24 13 150 232 KF-CR2 (HY005-F)



8 595025 318695





- conductor: H05VV-F 3G
- length: 5 m
- type of insulation: PVC
- colour: black
- conductor cross section: 3× 1.0 mm²
- type: KF-CR2 (HY005-F)



packaging: 1 pc, hanging

S18322 1/5/-/35

24 13 220 232 KF-CR2 (HY005-F)



8 595025 318701





- conductor: H05VV-F 3G
- length: 2 m
- type of insulation: PVC
- colour: black
- conductor cross section: 3× 1.5 mm²
- type: KF-CR2 (HY005-F)



packaging: 1 pc, hanging

S18323 1/5/-/30

24 13 230 232 KF-CR2 (HY005-F)



8 595025 318718





- conductor: H05VV-F 3G
- length: 3 m
- type of insulation: PVC
- colour: black
- conductor cross section: 3× 1.5 mm²
- type: KF-CR2 (HY005-F)



packaging: 1 pc, hanging

S18325 1/5/-/20

24 13 250 232 KF-CR2 (HY005-F)



8 595025 318725





- conductor: H05VV-F 3G
- length: 5 m
- type of insulation: PVC
- colour: black
- conductor cross section: 3× 1.5 mm²
- type: KF-CR2 (HY005-F)



packaging: 1 pc, hanging

S11370 1/-/-/50

24 17 715 202 JT003/JT-ST3 (LA010A)



8 595025 323118

- conductor: H05VV-F 3G
- length: 1.5 m
- type of insulation: PVC
- colour: black
- conductor cross section: 3× 0.75 mm²
- type: JT003/JT-ST3

packaging: 1 pc, hanging

Cables



Data cables UTP, FTP

Data cables CAT 5E

- EMOS structured cabling components always in top quality
- guarantee maximum output, flawless running, long life
- UTP/FTP cables meet standards EN 50173, ANSI/TIA/EIA 568
- also comply with ISO/IEC 11801
- certified by accredited testing and calibration laboratory
- meet standard ČSN EN 50575 (reaction to fire)

type: UTP CAT 5E PVC BASIC = cable structure: wire = material of the inner conductor: copper (Cu) = wire insulation: HDPE = strength member: Nylon 150D = cable sheath: PVC = jacket diameter: 5.0 mm = highest supported protocol: 1000 Base-T (Gigabit Ethernet) = reaction to the fire: Eca = dangerous substances: none = packaging: 305 m, paper box



S9134

305/-/-/305

23 09 010 120 UTP CAT5E PVC BASIC

type: UTP CAT 5E PVC = cable structure: wire = material of the inner conductor: copper (Cu) = wire insulation: HDPE = strength member: Nylon 150D = cable sheath: PVC = jacket diameter: 5.2 mm = highest supported protocol: 1000 Base-T (Gigabit Ethernet) = reaction to the fire: Eca = dangerous substances: none = packaging: 305 m, paper box



S9121

305/-/-/305

23 09 010 010 UTP CAT5E PVC



type: UTP CAT 5E LSZH = cable structure: wire = material of the inner conductor: copper (Cu) = wire insulation: HDPE = strength member: Nylon 150D = cable sheath: LSZH = jacket diameter: 5.2 mm = low smoke zero halogen (LSZH) coat = highest supported protocol: 1000 Base-T (Gigabit Ethernet) = reaction to the fire: Dca-s2-d2-a1 = dangerous substances: none = packaging: 305 m, paper box



S9129 305/-/-/305
23 09 010 090 UTP CAT5E LSZH

type: FTP CAT 5E PVC = cable structure: wire = shielding: Al/PET 7/12-18 mm = material of the inner conductor: copper (Cu) = wire insulation: HDPE = strength member: Nylon 150D = cable sheath: PVC = jacket diameter: 6.0 mm = highest supported protocol: 1000 Base-T (Gigabit Ethernet) = reaction to the fire: Eca = dangerous substances: none = packaging: 305 m, paper box



S9221 305/-/-/305
23 09 110 010 FTP CAT5E PVC

type: FTP CAT 5E LSZH = cable structure: wire = shielding: Al/PET 7/12-18 mm = material of the inner conductor: copper (Cu) = wire insulation: HDPE = strength member: Nylon 150D = cable sheath: LSZH = jacket diameter: 6.0 mm = low smoke zero halogen (LSZH) coat = highest supported protocol: 1000 Base-T (Gigabit Ethernet) = reaction to the fire: Dca-s2-d2-a1 = dangerous substances: none = packaging: 305 m, paper box



S9222 305/-/-/305
23 09 110 020 FTP CAT5E LSZH

type: UTP CAT 5E CCA OEM = cable structure: wire = material of the inner conductor: copper clad Al (CCA) = wire insulation: HDPE = strength member: Nylon 150D = cable sheath: PVC = jacket diameter: 5.2 mm = highest supported protocol: 100 Base-TX = reaction to the fire: Eca = dangerous substances: none = packaging: 305 m, paper box



S9128 305/-/-/305
23 09 010 080 UTP CAT5E CCA

type: UTP CAT 5E 1M = cable structure: stranded wires = material of the inner conductor: copper clad Al (CCA) = wire insulation: HDPE = strength member: Nylon 150D = cable sheath: PVC = jacket diameter: 5 mm = highest supported protocol: 1000 Base-T (Gigabit Ethernet) = reaction to the fire: do not subject to CPR = dangerous substances: do not subject to CPR = packaging: 1 pc, PVC packet



S9122 1/5/25/100
23 09 010 020 UTP CAT5E PVC
1M



type: UTP CAT 5E 2M = cable structure: stranded wires = material of the inner conductor: copper clad Al (CCA)
 = wire insulation: HDPE = strength member: Nylon 150D = cable sheath: PVC = jacket diameter: 5 mm =
 highest supported protocol: 1000 Base-T (Gigabit Ethernet) = reaction to the fire: do not subject to CPR =
 dangerous substances: do not subject to CPR = packaging: 1 pc, PVC packet



S9123 1/-/-/60
 23 09 010 030 UTP CAT5E PVC 2M

type: UTP CAT 5E 3M = cable structure: stranded wires = material of the inner conductor: copper clad Al (CCA)
 = wire insulation: HDPE = strength member: Nylon 150D = cable sheath: PVC = jacket diameter: 5 mm =
 highest supported protocol: 1000 Base-T (Gigabit Ethernet) = reaction to the fire: do not subject to CPR =
 dangerous substances: do not subject to CPR = packaging: 1 pc, PVC packet



S9124 1/-/-/10/40
 23 09 010 040 UTP CAT5E PVC 3M

type: UTP CAT 5E 5M = cable structure: stranded wires = material of the inner conductor: copper clad Al (CCA)
 = wire insulation: HDPE = strength member: Nylon 150D = cable sheath: PVC = jacket diameter: 5 mm =
 highest supported protocol: 1000 Base-T (Gigabit Ethernet) = reaction to the fire: do not subject to CPR =
 dangerous substances: do not subject to CPR = packaging: 1 pc, PVC packet



S9125 1/-/-/10/20
 23 09 010 050 UTP CAT5E PVC 5M

type: UTP CAT 5E 10M = cable structure: stranded wires = material of the inner conductor: copper clad Al (CCA)
 = wire insulation: HDPE = strength member: Nylon 150D = cable sheath: PVC = jacket diameter: 5 mm =
 highest supported protocol: 1000 Base-T (Gigabit Ethernet) = reaction to the fire: do not subject to CPR =
 dangerous substances: do not subject to CPR = packaging: 1 pc, PVC packet



S9126 1/-/-/10/30
 23 09 010 060 UTP CAT5E PVC 10M

type: UTP CAT 5E 15M = cable structure: stranded wires = material of the inner conductor: copper clad Al (CCA)
 = wire insulation: HDPE = strength member: Nylon 150D = cable sheath: PVC = jacket diameter: 5 mm =
 highest supported protocol: 1000 Base-T (Gigabit Ethernet) = reaction to the fire: do not subject to CPR =
 dangerous substances: do not subject to CPR = packaging: 1 pc, PVC packet



S9127 1/-/-/5/20
 23 09 010 070 UTP CAT5E PVC 15M



www.emos.eu

Order Code
Item Number

Packaging
Type

type: UTP CAT 5E 25M = cable structure: stranded wires = material of the inner conductor: copper clad Al (CCA) = wire insulation: HDPE = cable sheath: PVC = jacket diameter: 5 mm = highest supported protocol: 1000 Base-T (Gigabit Ethernet) = reaction to the fire: do not subject to CPR = dangerous substances: do not subject to CPR = packaging: 1 pc, PVC packet



S9130 1/-/-/10
23 09 010 100 UTP CAT5E PVC
25M

Data cables CAT 6

- EMOS structured cabling components always in top quality
- guarantee maximum output, flawless running, long life
- UTP/FTP cables meet standards EN 50173, ANSI/TIA/EIA 568
- also comply with ISO/IEC 11801
- certified by accredited testing and calibration laboratory
- meet standard ČSN EN 50575 (reaction to fire)

type: UTP CAT 6 PVC = cable structure: wire = material of the inner conductor: copper (Cu) = wire insulation: HDPE = strength member: 150D nylon + PE cross = cable sheath: PVC = jacket diameter: 6.3 mm = highest supported protocol: 1000 Base-TX (Gigabit Ethernet) = reaction to the fire: Eca = dangerous substances: none = packaging: 305 m, paper box



S9131 305/-/-/305
23 09 020 010 UTP CAT6 PVC

type: UTP CAT 6 LSZH = cable structure: wire = material of the inner conductor: copper (Cu) = wire insulation: HDPE = strength member: 150D nylon + PE cross = cable sheath: LSZH = jacket diameter: 6.3 mm = low smoke zero halogen (LSZH) coat = highest supported protocol: 1000 Base-TX (Gigabit Ethernet) = reaction to the fire: Dca-s2-d2-a2 = dangerous substances: none = packaging: 305 m, paper box



S9132 305/-/-/305
23 09 020 020 UTP CAT6 LSZH

type: FTP CAT 6 LSZH = cable structure: wire = shielding: Al/PET 7/12-18 mm = material of the inner conductor: copper (Cu) = wire insulation: HDPE = strength member: 150D nylon + PE cross = cable sheath: LSZH = jacket diameter: 6.3 mm = highest supported protocol: 1000 Base-T (Gigabit Ethernet) = reaction to the fire: Dca-s2-d2-a2 = dangerous substances: none = packaging: 500 m, wooden drum



S9230 500/-/-/500
23 09 120 010 FTP CAT6 LSZH

type: STP CAT 6A LSZH = cable structure: wire = shielding: Al/PET 7/12-18 mm = material of the inner conductor: copper (Cu) = wire insulation: HDPE = strength member: 150D nylon + PE cross = cable sheath: LSZH = jacket diameter: 7.6 mm = low smoke zero halogen (LSZH) coat = highest supported protocol: 10GBASE-T = reaction to the fire: B2ca-s1-d1-a1 = dangerous substances: none = packaging: 500 m, wooden drum



S9310 500/-/-/500
23 09 130 010 STP CAT6A LSZH

type: FFTP CAT 6A LSZH = cable structure: wire = shielding: Al/PET 7/12-18 mm = material of the inner conductor: copper (Cu) = wire insulation: HDPE = strength member: 150D nylon + PE cross = cable sheath: LSZH = jacket diameter: 7.6 mm = low smoke zero halogen (LSZH) coat = highest supported protocol: 10GBASE-T = reaction to the fire: Dca-s1-d2-a1 = dangerous substances: none = packaging: 500 m, wooden drum



S9320 500/-/-/500
23 09 130 020 FFTP CAT6A LSZH

Connectors, patch accessories

Connection patch cables, accessories

- for data transfer in computer and telecommunication networks
- terminate in RJ45 connectors (in category CAT5E or CAT6)
- length: 1-25 m, diameter: 5 mm, PVC jacket, 5 year warranty
- separate RJ45 (CAT5E) sockets and connectors also available

- type: connector RJ45 8p8c = packaging: 20 pcs, PVC packet
- category: CAT6
- designed for cable: UTP
- using: solid wire
- min. lifetime: 1 000 connect/disconnect cycles
- storage temperature: -40-70 °C
- operating temperature: -10-60 °C
- maximum operating humidity: 93 %
- dimensions: 22 × 12 × 10 mm



K0103 20/-/-/5 000
18 21 000 700 RJ45 6 UTP SOLID

- type: connector RJ45 8p8c
 - category: CAT5E
 - designed for cable: FTP, SFTP, F/UTP
 - using: solid wire
 - shielding
 - min. lifetime: 1 000 connect/disconnect cycles
 - storage temperature: -40-70 °C
 - operating temperature: -10-60 °C
 - maximum operating humidity: 93 %
- dimensions: 22 × 12 × 10 mm
 - packaging: 20 pcs, PVC packet



K0201

20/-/-/5 000

18 21 100 100

RJ45 5E FTP
SOLID

- type: connector RJ45 8p8c
 - category: CAT6
 - designed for cable: FTP, SFTP, F/UTP
 - using: solid wire
 - shielding
 - min. lifetime: 1 000 connect/disconnect cycles
 - storage temperature: -40-70 °C
 - operating temperature: -10-60 °C
 - maximum operating humidity: 93 %
- dimensions: 22 × 12 × 10 mm
 - packaging: 20 pcs, PVC packet



K0202

20/-/-/5 000

18 21 100 200

RJ45 6 FTP SOLID

- type: RJ45 connector protection
- using: reduces the stress of RJ45 connector
- dimensions: 30 × 13 × 11 mm
- packaging: 20 pcs, PVC packet



K0141

20/-/-/5 000

18 21 000 400

RJ45 PROOF
BLACK

- type: RJ45 connector protection
- using: reduces the stress of RJ45 connector
- dimensions: 30 × 13 × 11 mm
- packaging: 20 pcs, PVC packet



K0151

20/-/-/5 000

18 21 000 600

RJ45 PROOF
GRAY

- type: connector RJ45 8p8c
 - category: CAT5E
 - designed for cable: UTP
 - using: litz wire
 - min. lifetime: 1 000 connect/disconnect cycles
 - storage temperature: -40-70 °C
 - operating temperature: -10-60 °C
 - maximum operating humidity: 93 %
 - dimensions: 22 × 12 × 10 mm
- packaging: 20 pcs, PVC packet



K0101

20/-/-/5 000

18 21 000 100

RJ45 5E UTP
WIRE

- type: connector RJ45 8p8c
- category: CAT5E
- designed for cable: UTP
- using: solid wire
- min. lifetime: 1 000 connect/disconnect cycles
- storage temperature: -40-70 °C
- operating temperature: -10-60 °C
- maximum operating humidity: 93 %
- dimensions: 22 × 12 × 10 mm

▪ packaging: 20 pcs, PVC packet



K0102

20/-/-/5 000

18 21 000 500

RJ45 5E UTP
SOLID

- type: UTP socket wall mount
- reaction to the fire: do not subject to CPR
- dangerous substances: do not subject to CPR
- packaging: 1 pc, PVC packet



J0401

1/-/25/250

25 12 000 100

2XRJ45 SOCKET

- type: keystone RJ45 CAT5E
- category: CAT5E
- designed for cable: UTP
- using: solid wire
- min. lifetime: 1 000 connect/disconnect cycles
- storage temperature: -40-70 °C
- operating temperature: -10-60 °C
- maximum operating humidity: 93 %
- dimensions: 31 × 20 × 15 mm

▪ packaging: 1 pc, PVC packet



K0301

1/10/-/500

18 21 000 800

KSTUTP CAT5E

- type: keystone RJ45 CAT5E
- category: CAT5E
- designed for cable: FTP, SFTP, F/UTP
- using: solid wire
- shielding
- min. lifetime: 1 000 connect/disconnect cycles
- storage temperature: -40-70 °C
- operating temperature: -10-60 °C
- maximum operating humidity: 93 %

▪ dimensions: 31 × 20 × 15 mm
▪ packaging: 1 pc, PVC packet



K0311

1/10/-/500

18 21 100 300

KSTFTP CAT5E

- type: keystone RJ45 CAT6
- category: CAT6
- designed for cable: FTP, SFTP, F/UTP
- using: solid wire
- shielding
- min. lifetime: 1 000 connect/disconnect cycles
- storage temperature: -40-70 °C
- operating temperature: -10-60 °C
- maximum operating humidity: 93 %

▪ dimensions: 31 × 20 × 15 mm
▪ packaging: 1 pc, PVC packet



K0312

1/10/-/500

18 21 100 301

KSTFTP CAT6

Connectors IEC, F, reductions

- IEC connectors: straight/angle couplers, plugs and sockets
- F connectors available as straight/angled, screwed/inserted
- F connector size depends on coaxial cable thickness (4–5 mm)

K1331 10/-/-/2 500

18 04 100 100

A203R



8 595025 356710



10×

- version: plug
- type: direct
- packaging: 10 pcs, packet

K1731 10/-/-/2 500

18 04 000 100

A204R



8 595025 356796



10×

- version: socket
- type: direct
- packaging: 10 pcs, packet

K1451 10/-/-/2 500

18 04 100 500

A224



8 595025 356772



10×

- version: plug
- type: angular
- packaging: 10 pcs, packet

K1851 10/-/-/2 500

18 04 000 500

A224F



8 595025 356857



10×

- version: socket
- type: angular
- packaging: 10 pcs, packet

K1421 10/-/-/2 500

18 04 100 300

A205R



8 595025 356741



10×

- version: plug
- type: angular
- packaging: 10 pcs, packet

K1821 10/-/-/2 500

18 04 000 300

A206R



8 595025 356826



10×

- version: socket
- type: angular
- packaging: 10 pcs, packet

R5060 10/-/-/2 500

18 04 300 100

A223R



8 595025 357472



10×

- version: coupling
- type: direct
- packaging: 10 pcs, packet

K7311 10/-/-/4 000

18 07 100 300

M5609L



8 595025 357311



10×

- version: screw plug
- type: screwing
- for coax: 3C2V
- dimensions: 4.0/4.9 mm
- packaging: 10 pcs, packet

K7321 10/-/-/4 000
18 07 100 400 M5609M



- version: plug
- type: screwing
- for coax: CB-500
- dimensions: 4.0/5.5 mm
- packaging: 10 pcs, packet



10x

K7331 10/-/-/4 000
18 07 100 500 M5609H



- version: plug
- type: screwing
- for coax: CB-100
- dimensions: 5.0/6.5 mm
- packaging: 10 pcs, packet



10x

K7351 10/-/-/4 000
18 07 100 700 M7351T



- version: plug
- type: screwing
- for coax: CB-113N
- dimensions: 5.0/7.0 mm
- packaging: 10 pcs, packet



10x

R5602 10/-/-/4 000
18 07 300 100 M5602



- version: coupling
- type: screwing
- for coax: any
- packaging: 10 pcs, packet



10x

R5610 10/-/-/2 000
18 07 300 200 M5610



- version: coupling
- type: screwing
- for coax: any
- packaging: 10 pcs, packet



10x

R5639 10/-/-/2 000
18 07 200 100 M5639



- version: reduction
- type: screwing
- for coax: any
- packaging: 10 pcs, packet



10x

R5851 10/-/-/2 000
18 07 200 600 M5851



- version: reduction IEC-F
- type: screwing/slip-on
- for coax: any
- packaging: 10 pcs, packet



10x

R5852 10/-/-/2 000
18 07 200 700 M5852



- version: reduction F-IEC
- type: screwing/slip-on
- for coax: any
- packaging: 10 pcs, packet



10x

R5553 10/-/-/1 500
18 07 200 300 M5553



- version: reduction F-BNC
- type: screwing/slip-on
- for coax: any
- packaging: 10 pcs, packet



10x

R5850 10/-/-/2 000
18 07 200 500 M5850



- version: reduction F-IEC
- type: screwing/slip-on
- for coax: any
- packaging: 10 pcs, packet



10x

K9304 1/150/-/150
18 11 000 200 K9304



- connectors: SCART – 3× CINCH + SVHS
- switch IN/OUT
- packaging: 1 pc, packet



K1731.2 2/-/20/480
18 04 000 600 K1731.2



- version: socket
- type: direct
- packaging: 2 pc, paper blister



K1821.2 2/-/20/480
18 04 000 601 K1821.2



- version: socket
- type: angular
- packaging: 2 pc, paper blister



K1851.2 2/-/20/480
18 04 000 602 K1851.2



- version: socket
- type: angular
- packaging: 2 pc, paper blister



K1331.2 2/-/20/480
18 04 100 701 K1331.2



- version: plug
- type: direct
- packaging: 2 pc, paper blister



K1421.2 2/-/20/480
18 04 100 702 K1421.2



- version: plug
- type: angular
- packaging: 2 pc, paper blister



K1451.2 2/-/20/480
18 04 100 703 K1451.2



- version: plug
- type: angular
- packaging: 2 pc, paper blister



R5060.2 2/-/20/480
18 04 300 200 R5060.2



- version: coupling
- type: direct
- packaging: 2 pc, paper blister



K7321.2 2/-/20/480
18 07 100 800 K7321.2



- version: plug
- type: screwing
- for coax: CB-500
- dimensions: 4.0/5.5 mm
- packaging: 2 pc, paper blister



K7331.2 2/-/20/480
18 07 100 801 K7331.2



- version: plug
- type: screwing
- for coax: CB-100
- dimensions: 5.0/6.5 mm
- packaging: 2 pc, paper blister







www.emos.eu

Order Code
Item Number

Packaging
Type





K7351.2 2/-/20/480
18 07 100 802 K7351.2



- version: plug
- type: screwing
- for coax: CB-113N
- dimensions: 5.0/7.0 mm
- packaging: 2 pc, paper blister

R5850.2 2/-/20/480
18 07 100 803 R5850.2

- version: reduction F-IEC
- type: screwing/slip-on
- for coax: any
- packaging: 2 pc, paper blister

R5852.2 2/-/20/480
18 07 100 804 R5852.2



- version: reduction F-IEC
- type: screwing/slip-on
- for coax: any
- packaging: 2 pc, paper blister

R5639.2 2/-/20/480
18 07 201 000 R5639.2



- version: reduction
- type: screwing
- for coax: any
- packaging: 2 pc, paper blister

R5602.2 2/-/20/480
18 07 300 300 R5602.2

- version: coupling
- type: screwing
- for coax: any
- packaging: 2 pc, paper blister

R5610.2 2/-/20/480
18 07 300 301 R5610.2



- version: coupling
- type: screwing
- for coax: any
- packaging: 2 pc, paper blister

Twin-shielded cables CYH

- transparent audio dual links made of OFC
- copper purity: 99.999 %
- CYH dual links in white or black

- conductor cross section: 0.75 mm²
- diameter of the inner conductor: 105× 0.095 mm
- sheath color: transparent, transparent
- maximum operating voltage: 50 V
- packaging: 100 m, reel



S8307 100/-/-/400
23 08 207 500 SPTP075

- conductor cross section: 1.0 mm²
- diameter of the inner conductor: 140× 0.095 mm
- sheath color: transparent, transparent
- maximum operating voltage: 50 V
- packaging: 100 m, reel



S8310 100/-/-/400
23 08 210 000 SPTP100

- conductor cross section: 1.5 mm²
- diameter of the inner conductor: 210× 0.095 mm
- sheath color: transparent, transparent
- maximum operating voltage: 50 V
- packaging: 100 m, reel



S8314 100/-/-/200
23 08 215 000 SPTP150

- conductor cross section: 2.5 mm²
- diameter of the inner conductor: 350× 0.095 mm
- sheath color: transparent, transparent
- maximum operating voltage: 50 V
- packaging: 100 m, reel



S8324 100/-/-/200
23 08 225 000 SPTP250

- conductor cross section: 2.5 mm²
- diameter of the inner conductor: 123× 0.16 mm
- sheath color: transparent, transparent
- maximum operating voltage: 50 V
- packaging: 100 m, PE foil

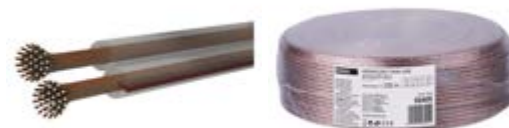

S8405 100/-/-/200
23 08 325 000 SPTP250 ECO

- conductor cross section: 0.15 mm²
- diameter of the inner conductor: 14× 0.12 mm
- sheath color: white, white
- maximum operating voltage: 50 V
- packaging: 200 m, reel



S8131 200/-/-/800
23 08 201 510 BCYH015W

- conductor cross section: 0.35 mm²
- diameter of the inner conductor: 30× 0.12 mm
- sheath color: white, white
- maximum operating voltage: 50 V
- packaging: 100 m, reel



S8231 100/-/-/400
23 08 203 510 BCYH035W



- conductor cross section: 0.5 mm²
- diameter of the inner conductor: 45× 0.12 mm
- sheath color: white, white
- maximum operating voltage: 50 V
- packaging: 100 m, reel



S8251 100/-/-/400
23 08 205 010 BCYH050W



- conductor cross section: 0.75 mm²
- diameter of the inner conductor: 67× 0.12 mm
- sheath color: white, white
- maximum operating voltage: 50 V
- packaging: 100 m, reel



S8271 100/-/-/400
23 08 207 510 BCYH075W



- conductor cross section: 1.0 mm²
- diameter of the inner conductor: 90× 0.12 mm
- sheath color: white, white
- maximum operating voltage: 50 V
- packaging: 100 m, reel



S8281 100/-/-/200
23 08 210 010 BCYH100W



- conductor cross section: 1.5 mm²
- diameter of the inner conductor: 133× 0.12 mm
- sheath color: white, white
- maximum operating voltage: 50 V
- packaging: 100 m, reel



S8291 100/-/-/200
23 08 215 010 BCYH150W



- conductor cross section: 0.15 mm²
- diameter of the inner conductor: 14× 0.12 mm
- sheath color: black, black/red
- maximum operating voltage: 50 V
- packaging: 200 m, reel



S8130 200/-/-/800
23 08 201 550 BCYH015BKR



- conductor cross section: 0.35 mm²
- diameter of the inner conductor: 30× 0.12 mm
- sheath color: black, black/red
- maximum operating voltage: 50 V
- packaging: 100 m, reel



S8230 100/-/-/400
23 08 203 550 BCYH035BKR



- conductor cross section: 0.5 mm²
- diameter of the inner conductor: 45× 0.12 mm
- sheath color: black, black/red
- maximum operating voltage: 50 V
- packaging: 100 m, reel

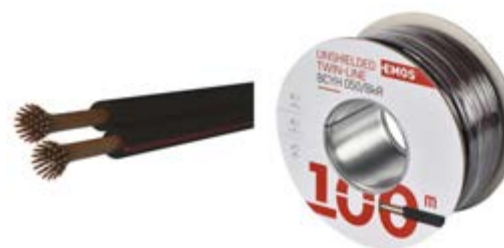

S8250 100/-/-/400
23 08 205 050 BCYH050BKR



- conductor cross section: 0.75 mm²
- diameter of the inner conductor: 67× 0.12 mm
- sheath color: black, black/red
- maximum operating voltage: 50 V
- packaging: 100 m, reel



S8270 100/-/-/400
23 08 207 550 BCYH075BKR



- conductor cross section: 1.0 mm²
- diameter of the inner conductor: 90× 0.12 mm
- sheath color: black, black/red
- maximum operating voltage: 50 V
- packaging: 100 m, reel



S8280 100/-/-/200
23 08 210 050 BCYH100BKR



- conductor cross section: 1.5 mm²
- diameter of the inner conductor: 133× 0.12 mm
- sheath color: black, black/red
- maximum operating voltage: 50 V
- packaging: 100 m, reel



S8290 100/-/-/200
23 08 215 050 BCYH150BKR

- conductor cross section: 0.5 mm²
- diameter of the inner conductor: 45× 0.12 mm
- sheath color: black, black/red
- maximum operating voltage: 50 V
- packaging: 100 m, PE foil



S8253 100/-/400/800
23 08 305 050 SPBKR050 ECO

- conductor cross section: 0.75 mm²
- diameter of the inner conductor: 67× 0.12 mm
- sheath color: black, black/red
- maximum operating voltage: 50 V
- packaging: 100 m, PE foil



S8273 100/-/400/800
23 08 307 550 SPBKR075 ECO

- conductor cross section: 1.0 mm²
- diameter of the inner conductor: 50× 0.16 mm
- sheath color: black, black/red
- maximum operating voltage: 50 V
- packaging: 100 m, PE foil



S8283 100/-/-/400
23 08 310 050 SPBKR100 ECO

- conductor cross section: 1.5 mm²
- diameter of the inner conductor: 133× 0.12 mm
- sheath color: black, black/red
- maximum operating voltage: 50 V
- packaging: 100 m, PE foil



S8293 100/-/-/400
23 08 315 050 SPBKR150 ECO

Coaxial cables

Coaxial cables 50 Ohm

- line of high-quality coaxial cables for indoor & outdoor use
- quality of CB series coax. cables guarantees long cable life
- purity of copper ensures stability & excellent transmission
- wide range for choosing the right cable for your application
- certified by accredited testing and calibration laboratory
- meet standard ČSN EN 50575 (products' reaction to fire)
- quality of CB series coax. cables guarantees long cable life

coaxial cable type: RG58/U = intended use: short distribution systems, telecommunication antenna connections = UV resistant = suitable for outdoor use = material of the inner conductor: stranded wires, copper (Cu) = diameter of the inner conductor: 17× 0.19 mm = dielectric type, diameter: SPE 3.0 mm = number of shieldings: 1 = material of the shielding: copper clad aluminium (CCA) = number of braiding wires: 112× 0.12 mm = diameter of cable sheath: 5 mm = material of the cable jacket: PVC = color cable sheath > Cable sheath color: black = reaction to the fire: Eca = dangerous substances: none = packaging: 500 m, wooden drum

**S5213**

500/-/-/500

23 05 058 401

RG58U

Coaxial cables 75 Ohm

- line of high-quality coaxial cables for indoor & outdoor use
- quality of CB series coax. cables guarantees long cable life
- purity of copper ensures stability & excellent transmission
- wide range for choosing the right cable for your application
- certified by accredited testing and calibration laboratory
- meet standard ČSN EN 50575 (products' reaction to fire)
- quality of CB series coax. cables guarantees long cable life

coaxial cable type: CB113 = intended use: tertiary distribution CATV, SAT = material of the inner conductor: copper (Cu) = diameter of the inner conductor: 1.13 mm = dielectric type, diameter: FPE 4.8 mm = number of shieldings: 3 = shielding I. foil: 1× Al/PES = material of the shielding: tinned cooper (CuSn) = number of braiding wires: 144× 0,12 mm = shielding II. foil: Al/PES spiral = diameter of cable sheath: 7,05 mm = material of the cable jacket: PVC = color cable sheath > Cable sheath color: white = reaction to the fire: Eca = dangerous substances: none = packaging: 100 m, reel

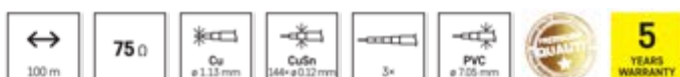
**S5261**

100/-/-/200

23 05 113 000

CB113

coaxial cable type: CB113 = intended use: tertiary distribution CATV, SAT = material of the inner conductor: copper (Cu) = diameter of the inner conductor: 1.13 mm = dielectric type, diameter: FPE 4.8 mm = number of shieldings: 3 = shielding I. foil: 1x Al/PES = material of the shielding: tinned cooper (CuSn) = number of braiding wires: 144x 0,12 mm = shielding II. foil: Al/PES spiral = diameter of cable sheath: 7,05 mm = material of the cable jacket: PVC = color cable sheath > Cable sheath color: white = reaction to the fire: Eca = dangerous substances: none = packaging: 250 m, reel box



S5262 250/-/-250
23 05 113 002 CB113

coaxial cable type: CB113 = intended use: tertiary distribution CATV, SAT = material of the inner conductor: copper (Cu) = diameter of the inner conductor: 1.13 mm = dielectric type, diameter: FPE 4.8 mm = number of shieldings: 3 = shielding I. foil: 1x Al/PES = material of the shielding: tinned cooper (CuSn) = number of braiding wires: 144x 0,12 mm = shielding II. foil: Al/PES spiral = diameter of cable sheath: 7,05 mm = material of the cable jacket: PVC (HD 624) = color cable sheath > Cable sheath color: white = reaction to the fire: Eca = dangerous substances: none = packaging: 500 m, wooden drum

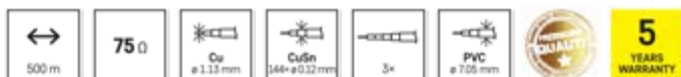

S5268 500/-/-500
23 05 113 003 CB113

coaxial cable type: CB113UV = intended use: outdoor installation, tertiary distribution = UV resistant = suitable for outdoor use = material of the inner conductor: copper (Cu) = diameter of the inner conductor: 1.13 mm = dielectric type, diameter: FPE 4.8 mm = number of shieldings: 3 = shielding I. foil: 1x Al/PES = material of the shielding: tinned cooper (CuSn) = number of braiding wires: 144x 0,12 mm = shielding II. foil: Al/PES spiral = diameter of cable sheath: 7,05 mm = material of the cable jacket: PVC UV resistant = color cable sheath > Cable sheath color: black = reaction to the fire: Eca = dangerous substances: none = packaging: 100 m, reel

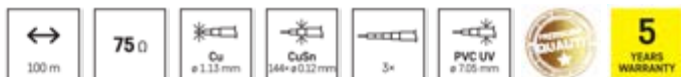

S5265 100/-/-200
23 05 113 500 CB113UV

coaxial cable type: CB113UV = intended use: outdoor installation, tertiary distribution = UV resistant = suitable for outdoor use = material of the inner conductor: copper (Cu) = diameter of the inner conductor: 1.13 mm = dielectric type, diameter: FPE 4.8 mm = number of shieldings: 3 = shielding I. foil: 1x Al/PES = material of the shielding: tinned cooper (CuSn) = number of braiding wires: 144x 0,12 mm = shielding II. foil: Al/PES spiral = diameter of cable sheath: 7,05 mm = material of the cable jacket: PVC UV resistant = color cable sheath > Cable sheath color: black = reaction to the fire: Eca = dangerous substances: none = packaging: 250 m, reel box

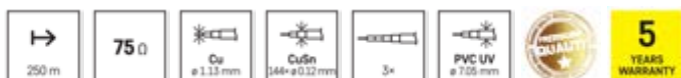

S5266 250/-/-250
23 05 113 502 CB113UV

coaxial cable type: CB100F = intended use: indoor installation, universal cable = material of the inner conductor: copper (Cu) = diameter of the inner conductor: 1.0 mm = dielectric type, diameter: FPE 4.6 mm = number of shieldings: 2 = shielding I. foil: 1x Al/PES = material of the shielding: tinned cooper (CuSn) = number of braiding wires: 48x 0.12 mm = diameter of cable sheath: 6.5 mm = material of the cable jacket: PVC = color cable sheath > Cable sheath color: white = reaction to the fire: Eca = dangerous substances: none = packaging: 100 m, reel

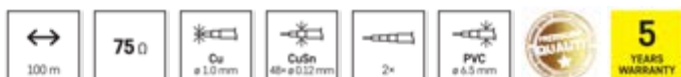

S5141 100/-/-200
23 05 100 200 CB100F

coaxial cable type: CB100F = intended use: indoor installation, universal cable = material of the inner conductor: copper (Cu) = diameter of the inner conductor: 1.0 mm = dielectric type, diameter: FPE 4.6 mm = number of shieldings: 2 = shielding I. foil: 1× Al/PES = material of the shielding: tinned cooper (CuSn) = number of braiding wires: 48× 0.12 mm = diameter of cable sheath: 6.5 mm = material of the cable jacket: PVC = color cable sheath > Cable sheath color: white = reaction to the fire: Eca = dangerous substances: none = packaging: 250 m, reel box

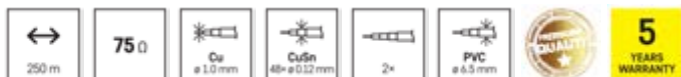

S5241S 250/-/-500
23 05 100 201 CB100F

coaxial cable type: CB21D = intended use: indoor installation, interference resistant, CLASS A = material of the inner conductor: copper (Cu) = diameter of the inner conductor: 1.1 mm = dielectric type, diameter: FPE 4.8 mm = number of shieldings: 2 = shielding I. foil: 1× Al/PET = material of the shielding: aluminium (Al) = number of braiding wires: 128× 0.12 mm = diameter of cable sheath: 6.8 mm = material of the cable jacket: PVC = color cable sheath > Cable sheath color: white = reaction to the fire: Eca = dangerous substances: none = packaging: 100 m, reel

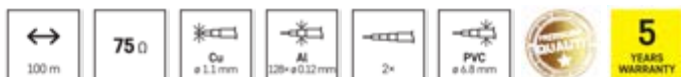

S5271 100/-/-200
23 05 021 000 CB21D

coaxial cable type: CB21D = intended use: indoor installation, interference resistant, CLASS A = material of the inner conductor: copper (Cu) = diameter of the inner conductor: 1.1 mm = dielectric type, diameter: FPE 4.8 mm = number of shieldings: 2 = shielding I. foil: 1× Al/PET = material of the shielding: aluminium (Al) = number of braiding wires: 128× 0.12 mm = diameter of cable sheath: 6.8 mm = material of the cable jacket: PVC = color cable sheath > Cable sheath color: white = reaction to the fire: Eca = dangerous substances: none = packaging: 500 m, wooden drum



S5273 500/-/-500
23 05 021 100 CB21D

coaxial cable type: CB50F = intended use: indoor installation, universal cable = material of the inner conductor: copper (Cu) = diameter of the inner conductor: 0.9 mm = dielectric type, diameter: FPE 4.4 mm = number of shieldings: 2 = shielding I. foil: 1× Al = material of the shielding: tinned cooper (CuSn) = number of braiding wires: 32× 0.12 mm = diameter of cable sheath: 6.3 mm = material of the cable jacket: PVC = color cable sheath > Cable sheath color: white = reaction to the fire: Eca = dangerous substances: none = packaging: 100 m, reel



S5131 100/-/-200
23 05 050 200 CB50F/ RG6 CUSN

coaxial cable type: CB50F = intended use: indoor installation, universal cable = material of the inner conductor: copper (Cu) = diameter of the inner conductor: 0.9 mm = dielectric type, diameter: FPE 4.4 mm = number of shieldings: 2 = shielding I. foil: 1× Al = material of the shielding: tinned cooper (CuSn) = number of braiding wires: 32× 0.12 mm = diameter of cable sheath: 6.3 mm = material of the cable jacket: PVC = color cable sheath > Cable sheath color: white = reaction to the fire: Eca = dangerous substances: none = packaging: 250 m, reel box



S5231S 250/-/-250
23 05 050 201 CB50F/ RG6 CUSN

coaxial cable type: CB125 = intended use: indoor installation, universal cable = material of the inner conductor: copper (Cu) = diameter of the inner conductor: 1.00 mm = dielectric type, diameter: FPE 4.8 mm = number of shieldings: 2 = shielding I. foil: CCA/PES = material of the shielding: copper clad aluminium (CCA) = number of braiding wires: 64×0.12 mm = diameter of cable sheath: 6.8 mm = material of the cable jacket: PVC (HD 624) = color cable sheath > Cable sheath color: white = reaction to the fire: Eca = dangerous substances: none = packaging: 100 m, reel



S5385 100/-/-/200
23 05 120 005 CB125

coaxial cable type: CB130 = intended use: indoor installation, universal cable = material of the inner conductor: copper clad steel (CCS) = diameter of the inner conductor: 1.02 mm = dielectric type, diameter: FPE 4.8 mm = number of shieldings: 2 = shielding I. foil: 1× Al/PES = material of the shielding: aluminium (Al) = number of braiding wires: 32×0.12 mm = diameter of cable sheath: 6.8 mm = material of the cable jacket: PVC = color cable sheath > Cable sheath color: white = reaction to the fire: Eca = dangerous substances: none = packaging: 100 m, reel



S5381 100/-/-/200
23 05 130 000 CB130 / RG6 U

coaxial cable type: CB130 = intended use: indoor installation, universal cable = material of the inner conductor: copper clad steel (CCS) = diameter of the inner conductor: 1.02 mm = dielectric type, diameter: FPE 4.8 mm = number of shieldings: 2 = shielding I. foil: 1× Al/PES = material of the shielding: aluminium (Al) = number of braiding wires: 32×0.12 mm = diameter of cable sheath: 6.8 mm = material of the cable jacket: PVC = color cable sheath > Cable sheath color: white = reaction to the fire: Eca = dangerous substances: none = packaging: 100 m, PVC foil



S5381E 100/-/-/400
23 05 130 010 CB130 / RG6 U

coaxial cable type: CB115/RG6 CU TRISHIELD = intended use: indoor installation, interference resistant, CLASS A = material of the inner conductor: copper (Cu) = diameter of the inner conductor: 1.02 mm = dielectric type, diameter: FPE 4.8 mm = number of shieldings: 3 = shielding I. foil: 1× Al/PET = material of the shielding: aluminium (Al) = number of braiding wires: 96×0.12 mm = shielding II. foil: Al/PET = diameter of cable sheath: 6.8 mm = material of the cable jacket: PVC = color cable sheath > Cable sheath color: white = reaction to the fire: Eca = dangerous substances: none = packaging: 100 m, reel

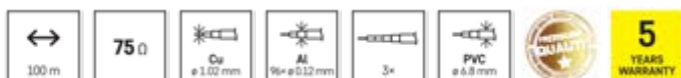

S5272 100/-/-/200
23 05 023 000 CB115/ RG6 CU TRISHIELD

coaxial cable type: CB500 = intended use: CATV distribution = material of the inner conductor: copper (Cu) = diameter of the inner conductor: 0.75 mm = dielectric type, diameter: FPE 3.2 mm = number of shieldings: 3 = shielding I. foil: 1× Al/PES = material of the shielding: tinned cooper (CuSn) = number of braiding wires: 48×0.12 mm = shielding II. foil: Al/PES = diameter of cable sheath: 5 mm = material of the cable jacket: PVC = color cable sheath > Cable sheath color: white = reaction to the fire: Eca = dangerous substances: none = packaging: 100 m, reel

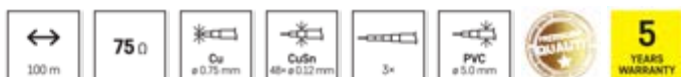

S5252 100/-/-/400
23 05 500 000 CB500

coaxial cable type: CB500 = intended use: terminals for connected users, CATV distribution = material of the inner conductor: copper (Cu) = diameter of the inner conductor: 0.75 mm = dielectric type, diameter: FPE 3.2 mm = number of shieldings: 3 = shielding I. foil: 1× Al/PES = material of the shielding: tinned cooper (CuSn) = number of braiding wires: 48× 0.12 mm = shielding II. foil: Al/PES spiral = diameter of cable sheath: 5 mm = material of the cable jacket: PVC = color cable sheath > Cable sheath color: white = reaction to the fire: Eca = dangerous substances: none = packaging: 250 m, reel box

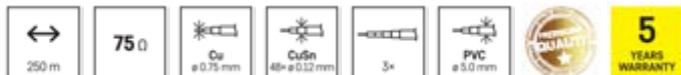

S5253 250/-/-/500
23 05 500 002 CB500

coaxial cable type: CB135 = intended use: indoor installation, interference resistant, CLASS A = material of the inner conductor: copper clad steel (CCS) = diameter of the inner conductor: 1.02 mm = dielectric type, diameter: FPE 4.8 mm = number of shieldings: 3 = shielding I. foil: 1× Al/PES = material of the shielding: aluminium (Al) = number of braiding wires: 64× 0.12 mm = shielding II. foil: Al/PES = diameter of cable sheath: 6.8 mm = material of the cable jacket: PVC = color cable sheath > Cable sheath color: white = reaction to the fire: Eca = dangerous substances: none = packaging: 100 m, reel



S5382 100/-/-/200
23 05 135 000 CB135

coaxial cable type: CB135 = intended use: unit connections, resistant to interference, CLASS A = material of the inner conductor: copper clad steel (CCS) = diameter of the inner conductor: 1.02 mm = dielectric type, diameter: FPE 4.8 mm = number of shieldings: 3 = shielding I. foil: 1× Al/PES = material of the shielding: aluminium (Al) = number of braiding wires: 64× 0.12 mm = shielding II. foil: Al/PES = diameter of cable sheath: 6.8 mm = material of the cable jacket: PVC = color cable sheath > Cable sheath color: white = reaction to the fire: Eca = dangerous substances: none = packaging: 500 m, wooden drum



S5383 500/-/-/500
23 05 135 010 CB135 500M

coaxial cable type: CB130 = intended use: indoor installation = material of the inner conductor: copper clad steel (CCS) = diameter of the inner conductor: 1.02 mm = dielectric type, diameter: FPE 4.8 mm = number of shieldings: 2 = shielding I. foil: 1× Al/PES = material of the shielding: aluminium (Al) = number of braiding wires: 32× 0.12 mm = diameter of cable sheath: 6.8 mm = material of the cable jacket: PVC = color cable sheath > Cable sheath color: white = reaction to the fire: do not subject to CPR = dangerous substances: do not subject to CPR = packaging: 5 m, headercard



S5373 1/-/-/16
23 05 120 010 CB130 / RG6 U

coaxial cable type: CB130 = intended use: indoor installation = material of the inner conductor: copper clad steel (CCS) = diameter of the inner conductor: 1.02 mm = dielectric type, diameter: FPE 4.8 mm = number of shieldings: 2 = shielding I. foil: 1× Al/PES = material of the shielding: aluminium (Al) = number of braiding wires: 32× 0.12 mm = diameter of cable sheath: 6.8 mm = material of the cable jacket: PVC = color cable sheath > Cable sheath color: white = reaction to the fire: do not subject to CPR = dangerous substances: do not subject to CPR = packaging: 10 m, hanging



S5374 1/-/-/24
23 05 120 020 CB130 / RG6 U

coaxial cable type: CB130 = intended use: indoor installation = material of the inner conductor: copper clad steel (CCS) = diameter of the inner conductor: 1.02 mm = dielectric type, diameter: FPE 4.8 mm = number of shieldings: 2 = shielding I. foil: 1× Al/PES = material of the shielding: aluminium (Al) = number of braiding wires: 32× 0.12 mm = diameter of cable sheath: 6.8 mm = material of the cable jacket: PVC = color cable sheath > Cable sheath color: white = reaction to the fire: do not subject to CPR = dangerous substances: do not subject to CPR = packaging: 15 m, headercard



S5375 1/-/-16
23 05 120 030 CB130 / RG6 U

coaxial cable type: CB130 = intended use: indoor installation = material of the inner conductor: copper clad steel (CCS) = diameter of the inner conductor: 1.02 mm = dielectric type, diameter: FPE 4.8 mm = number of shieldings: 2 = shielding I. foil: 1× Al/PES = material of the shielding: aluminium (Al) = number of braiding wires: 32× 0.12 mm = diameter of cable sheath: 6.8 mm = material of the cable jacket: PVC = color cable sheath > Cable sheath color: white = reaction to the fire: do not subject to CPR = dangerous substances: do not subject to CPR = packaging: 20 m, headercard



S5376 1/-/-16
23 05 120 040 CB130 / RG6 U

coaxial cable type: CB113 LSZH = intended use: unit connections, resistant to interference, CLASS A+ = material of the inner conductor: copper (Cu) = diameter of the inner conductor: 1.13 mm = dielectric type, diameter: FPE 4.8 mm = number of shieldings: 3 = shielding I. foil: 1× Al/PES = material of the shielding: tinned cooper (CuSn) = number of braiding wires: 144× 0,12 mm = shielding II. foil: Al/PES spiral = diameter of cable sheath: 7,05 mm = material of the cable jacket: LSZH = color cable sheath > Cable sheath color: white = reaction to the fire: Eca = dangerous substances: none = packaging: 250 m, paper reel box



S5269 250/-/-250
23 05 113 600 CB113 LSZH

coaxial cable type: RG59B/U = intended use: CCTV cabling = UV resistant = material of the inner conductor: copper plated steel = diameter of the inner conductor: 0,58 mm = dielectric type, diameter: SPE 3.7 mm = number of shieldings: 1 = shielding I. foil = material of the shielding: copper clad aluminium (CCA) = number of braiding wires: 128× 0.12 mm = diameter of cable sheath: 6.05 mm = material of the cable jacket: PVC = color cable sheath > Cable sheath color: black = reaction to the fire: Fca = dangerous substances: none = packaging: 500 m, wooden drum



S5194 500/-/-500
23 05 059 009 RG59BU/128SA

coaxial cable type: 3C2V = intended use: replacement of drilling of the walls = UV resistant = suitable for outdoor use = material of the inner conductor: copper (Cu) = diameter of the inner conductor: 0.5 mm = dielectric type, diameter: PE 1.6 mm = number of shieldings: 1 = material of the shielding: copper clad aluminium (CCA) = number of braiding wires: 32× 0.12 mm = diameter of cable sheath: 3 mm = material of the cable jacket: PVC = color cable sheath > Cable sheath color: white = reaction to the fire: do not subject to CPR = dangerous substances: do not subject to CPR = packaging: 1 pc, PE packet





S5378 1/-/-1 000
23 05 032 010 W-CABLE





Connection AV cables

AV cables blister





- cables for transmitting audio and video, blister pack
- STEREO: 3.5 mm jack (on 1 or 2 ends), length 1.5–5 m
- USB: 2.0 & 3.0, USB-A, micro, USB-C etc, Quick Charge, 1–2 m
- HDMI: multimedia TV cable, 3D or 4K, various plugs, 1.5–5 m
- SCART: SCART/SCART or SCART/RCA plug, length 1–3 m
- CINCH: 2× or 3× CINCH on both ends, length 1.5–5 m
- COAXIAL: antenna to TV, 1.25–15 m, angle/straight plug

SB3015	1/-/-/12	
23 33 130 150	SB3015	
	 	
8 595025 375766		





connectors: IEC plug – IEC socket = connector type: 2× direct = length: 15 m = number of shieldings: 2 = packaging: 1 pc, blister

SB3103	1/-/-/30	
23 33 131 030	SB3103	
	 	
8 595025 375797		

connectors: IEC plug – IEC socket 90° = connector type: 1× direct, 1× angular = length: 3.5 m = number of shieldings: 2 = packaging: 1 pc, blister

SB3110	1/-/12/24	
23 33 131 100	SB3110	
	 	
8 595025 375827		

connectors: IEC plug – IEC socket 90° = connector type: 1× direct, 1× angular = length: 10 m = number of shieldings: 2 = packaging: 1 pc, blister

SB3115	1/-/-/12	
23 33 131 150	SB3115	
	 	
8 595025 375834		

connectors: IEC plug – IEC socket 90° = connector type: 1× direct, 1× angular = length: 15 m = number of shieldings: 2 = packaging: 1 pc, blister

AV cables polybag

- cables for transmitting audio and video
- STEREO: 3.5 mm jack (on 1 or 2 ends), length 1.5–5 m
- USB: 2.0 & 3.0, USB-A, micro, USB-C etc, Quick Charge, 1–2 m
- HDMI: multimedia TV cable, 3D or 4K, various plugs, 1.5–10 m
- SCART: SCART/SCART or SCART/RCA plug, length 1–3 m
- CINCH: 2× or 3× CINCH on both ends, length 1.5–5 m
- COAXIAL: connect antenna to TV, 1.25–15 m, angle/straight plug

SD3010 1/-/-/30
23 34 130 100 SD3010



8 592920 002421



connectors: IEC plug – IEC socket = connector type: 2× direct = length: 10 m = number of shieldings: 2 = packaging: 1 pc, packet

AV cables hanger

- cables for transmitting audio and video
- USB: speed 2.0, with USB-A and micro USB plug, length 1 m
- HDMI: multimedia TV cable, 3D or 4K, 1.5 m, PVC or nylon
- SCART: SCART/SCART plugs, 1.5 m connection cable
- COAXIAL: connect antenna and TV, 1.25–7.5 m, straight plugs

SL0101 1/5/20/80
23 33 001 010 SL0101



8 595025 374868



connectors: A plug – A plug = connector type: 2× direct = length: 1.5 m = support of image resolution: 4K = maximum bit rate: 10.2 Gbit/s = material: PVC = packaging: plastic hanging

SL0301 1/5/20/80
23 33 003 010 SL0301



8 595025 374882



connectors: A plug – A plug = connector type: 2× direct = length: 1.5 m = support of image resolution: 4K = maximum bit rate: 10.2 Gbit/s = material: nylon = packaging: plastic hanging

SL2001 1/5/20/80
23 33 020 010 SL2001







8 595025 380487











length: 1.5 m = connectors: SCART plug – SCART plug = packaging: 1 pc, plastic hanging





AV cables paper blister





- high quality cables for indoor use
- stable video and audio transmission
- connection to all compatible devices thanks to straight and angled connectors





S10100	1/-/-/20	
23 33 101 011	S10100	
		
8 592920 107850		
<ul style="list-style-type: none"> ▪ connectors: A plug – A plug ▪ connector type: 2× direct ▪ length: 1.5 m ▪ HDMI version: 2.0 ▪ support of image resolution: 4K ▪ maximum bit rate: 18 Gbit/s 	<ul style="list-style-type: none"> ▪ material: PVC ▪ packaging: 1 pc, blister 	





S10102	1/-/-/20	
23 33 101 013	S10102	
		
8 592920 107904		
<ul style="list-style-type: none"> ▪ connectors: A plug – C plug ▪ connector type: 2× direct ▪ length: 1.5 m ▪ HDMI version: 2.0 ▪ support of image resolution: 4K ▪ maximum bit rate: 18 Gbit/s 	<ul style="list-style-type: none"> ▪ material: PVC ▪ packaging: 1 pc, blister 	



S10103	1/-/-/20	
23 33 101 014	S10103	
		
8 592920 107911		
<ul style="list-style-type: none"> ▪ connectors: A plug – D plug ▪ connector type: 2× direct ▪ length: 1.5 m ▪ HDMI version: 2.0 ▪ support of image resolution: 4K ▪ maximum bit rate: 18 Gbit/s 	<ul style="list-style-type: none"> ▪ material: PVC ▪ packaging: 1 pc, blister 	

S10110	1/-/-/20	
23 33 101 015	S10110	
		
8 592920 107928		
<ul style="list-style-type: none"> ▪ connectors: A plug – A plug ▪ connector type: 1× direct, 1× angular ▪ length: 1.5 m ▪ HDMI version: 2.0 ▪ support of image resolution: 4K ▪ maximum bit rate: 18 Gbit/s 	<ul style="list-style-type: none"> ▪ material: PVC ▪ packaging: 1 pc, blister 	



S10101	1/-/-/20	
23 33 101 016	S10101	
		
8 592920 107959		
<ul style="list-style-type: none"> ▪ connectors: A plug – A plug ▪ connector type: 2× direct ▪ length: 1.5 m ▪ HDMI version: 2.1 ▪ support of image resolution: 8K ▪ maximum bit rate: 48 Gbit/s 	<ul style="list-style-type: none"> ▪ material: PVC ▪ packaging: 1 pc, blister 	

S10300	1/-/-/20	
23 33 101 031	S10300	
		
8 592920 107867		
<ul style="list-style-type: none"> ▪ connectors: A plug – A plug ▪ connector type: 2× direct ▪ length: 3 m ▪ HDMI version: 2.0 ▪ support of image resolution: 4K ▪ maximum bit rate: 18 Gbit/s 	<ul style="list-style-type: none"> ▪ material: PVC ▪ packaging: 1 pc, blister 	

S10310	1/-/-/20	
23 33 101 032	S10310	
		
8 592920 107935		
<ul style="list-style-type: none"> ▪ connectors: A plug – A plug ▪ connector type: 1× direct, 1× angular ▪ length: 3 m ▪ HDMI version: 2.0 ▪ support of image resolution: 4K ▪ maximum bit rate: 18 Gbit/s 	<ul style="list-style-type: none"> ▪ material: PVC ▪ packaging: 1 pc, blister 	



S10500	1/-/-/10	
23 33 101 051	S10500	
		
8 592920 107874		
<ul style="list-style-type: none"> ▪ connectors: A plug – A plug ▪ connector type: 2× direct ▪ length: 5 m ▪ HDMI version: 2.0 ▪ support of image resolution: 4K ▪ maximum bit rate: 18 Gbit/s 	<ul style="list-style-type: none"> ▪ material: PVC ▪ packaging: 1 pc, blister 	

S10510 1/-/-/10
23 33 101 052 S10510



- connectors: A plug – A plug
- connector type: 1× direct, 1× angular
- length: 5 m
- HDMI version: 2.0
- support of image resolution: 4K
- maximum bit rate: 18 Gbit/s
- material: PVC
- packaging: 1 pc, blister

S10000 1/-/-/20
23 33 101 070 S10000



- connectors: A plug – A plug
- connector type: 2× direct
- length: 0.75 m
- HDMI version: 2.0
- support of image resolution: 4K
- maximum bit rate: 18 Gbit/s
- material: PVC
- packaging: 1 pc, blister

S11000 1/-/-/10
23 33 101 100 S11000



- connectors: A plug – A plug
- connector type: 2× direct
- length: 10 m
- HDMI version: 2.0
- support of image resolution: 4K
- maximum bit rate: 18 Gbit/s
- material: PVC
- packaging: 1 pc, blister

S30500 1/-/-/20
23 33 130 051 S30500



- connectors: IEC plug – IEC socket
- connector type: 2× direct
- length: 5 m
- number of shieldings: 2
- packaging: 1 pc, blister

S30510 1/-/-/20
23 33 130 052 S30510



- connectors: IEC plug – IEC socket
- connector type: 1× direct, 1× angular
- length: 5 m
- number of shieldings: 2
- packaging: 1 pc, blister

S31000 1/-/-/20
23 33 130 101 S31000



- connectors: IEC plug – IEC socket
- connector type: 2× direct
- length: 10 m
- number of shieldings: 2
- packaging: 1 pc, blister

S31010 1/-/-/20
23 33 130 102 S31010



- connectors: IEC plug – IEC socket
- connector type: 1× direct, 1× angular
- length: 10 m
- number of shieldings: 2
- packaging: 1 pc, blister

S30100 1/-/-/20
23 33 130 120 S30100



- connectors: IEC plug – IEC socket
- connector type: 2× direct
- length: 1.25 m
- number of shieldings: 2
- packaging: 1 pc, blister

S30110 1/-/-/20
23 33 130 121 S30110



- connectors: IEC plug – IEC socket
- connector type: 1× direct, 1× angular
- length: 1.25 m
- number of shieldings: 2
- packaging: 1 pc, blister

S31500 1/-/-/10
23 33 130 151 S31500



- connectors: IEC plug – IEC socket
- connector type: 2× direct
- length: 15 m
- number of shieldings: 2
- packaging: 1 pc, blister

S31510 1/-/-/12
23 33 130 152 S31510



- connectors: IEC plug – IEC socket
- connector type: 1× direct, 1× angular
- length: 15 m
- number of shieldings: 2
- packaging: 1 pc, blister

S30200 1/-/-/20
23 33 130 250 S30200



- connectors: IEC plug – IEC socket
- connector type: 2× direct
- length: 2.5 m
- number of shieldings: 2
- packaging: 1 pc, blister

S30210 1/-/-/20
23 33 130 251 S30210



- connectors: IEC plug – IEC socket
- connector type: 1× direct, 1× angular
- length: 2.5 m
- number of shieldings: 2
- packaging: 1 pc, blister

S30300 1/-/-/20
23 33 130 350 S30300



- connectors: IEC plug – IEC socket
- connector type: 2× direct
- length: 3.5 m
- number of shieldings: 2
- packaging: 1 pc, blister

S30310 1/-/-/20
23 33 130 351 S30310



- connectors: IEC plug – IEC socket
- connector type: 1× direct, 1× angular
- length: 3.5 m
- number of shieldings: 2
- packaging: 1 pc, blister

S30700 1/-/-/20
23 33 130 750 S30700



- connectors: IEC plug – IEC socket
- connector type: 2× direct
- length: 7.5 m
- number of shieldings: 2
- packaging: 1 pc, blister

S30710 1/-/-/20
23 33 130 751 S30710

- connectors: IEC plug – IEC socket
- connector type: 1× direct, 1× angular
- length: 7.5 m
- number of shieldings: 2
- packaging: 1 pc, blister

S70203 1/-/-/20
23 33 170 010 S70203

- length: 1 m
- connectors: A plug – micro B plug
- using: charging/data
- USB version: 3.0
- packaging: 1 pc, blister



S70200 1/-/-/20
23 33 170 021 S70200





- length: 2 m
- connectors: A plug – A plug
- using: charging/data
- USB version: 2.0
- packaging: 1 pc, blister

S70201 1/-/-/20
23 33 170 022 S70201

- length: 2 m
- connectors: A plug – A socket
- using: charging/data
- USB version: 2.0
- packaging: 1 pc, blister

S70202

1/-/-/20

23 33 170 023

S70202



- length: 2 m
- connectors: A plug – B plug
- using: charging/data
- USB version: 2.0
- packaging: 1 pc, blister

Smartphone cables

- connection, data and charging cables for phone or tablet
- phone USB cables – micro USB, USB-C & Lightning (for iPhone)
- with 2.0 and 3.0 speed, selected models with Quick Charge
- length 1–2 m, flat & round, classic/reeled, various colours
- universal extension USB cables/splitters, 3 connector types

length: 1 m = connectors: A plug – micro B plug = using: charging/data = USB version: 2.0 = packaging: 1 pc, small box



SM7004W

1/-/25/100

23 35 070 410

SM7004W

length: 1 m = connectors: A plug – micro B plug = using: charging/data = USB version: 2.0 = packaging: 1 pc, small box



SM7004B

1/-/25/100

23 35 070 420

SM7004B

length: 1 m = connectors: A plug – C plug = using: charging/data = USB version: 2.0 = packaging: 1 pc, small box



SM7025W

1/-/25/100

23 35 072 500

SM7025W

length: 1.5 m = connectors: A plug – C plug = using: charging/data = USB version: 2.0 = packaging: 1 pc, small box



SM7026 1/-/25/100
23 35 076 011 SM7026

length: 1 m = connectors: A plug – C plug = using: charging/data = USB version: 2.0 = packaging: 1 pc, small box



SM7025BL 1/-/25/100
23 35 072 501 SM7025BL

length: 1 m = connectors: A plug – C plug = using: charging/data = USB version: 3.1 = packaging: 1 pc, small box



SM7021BL 1/-/25/100
23 35 072 100 SM7021BL

length: 1 m = connectors: C plug – C plug = using: charging/data = USB version: 2.0 = packaging: 1 pc, small box



SM7027W 1/-/25/100
23 35 076 013 SM7027W

length: 1 m = connectors: C plug – C plug = using: charging/data = USB version: 3.1 = packaging: 1 pc, small box



SM7022BL 1/-/25/50
23 35 072 200 SM7022BL

length: 1 m = connectors: C plug – i16P plug = using: charging/data = USB version: 2.0 = packaging: 1 pc, small box



SM7015W 1/-/25/100
23 35 076 014 SM7015W

length: 1 m = connectors: A plug – i16P plug = using: charging/data = USB version: 2.0 = packaging: 1 pc, small box



SM7013W 1/-/25/100
23 35 071 310 SM7013W

connectors: micro B socket – C plug = using: charging/data = USB version: 2.0 = packaging: 2 pcs, small box



SM7023 2/-/50/200
23 35 072 310 SM7023

connectors: 3.5 mm plug – 3.5 mm plug = stereo = length: 1.5 m = packaging: 1 pc, small box



SM5001 1/-/-/120
23 35 050 010 SM5001

connectors: 3.5 mm plug – 3.5 mm socket = stereo = length: 2.5 m = packaging: 1 pc, small box



SM5102 1/-/-/120
23 35 050 020 SM5102

connectors: 3.5 mm plug – 3.5 mm plug = stereo = length: 3 m = packaging: 1 pc, small box



SM5003 1/-/-/100
23 35 050 030 SM5003

connectors: 3.5 mm plug – 3.5 mm socket = stereo = length: 5 m = packaging: 1 pc, small box



SM5105 1/-/-/100
23 35 050 050 SM5105

length: 0.15 m = connectors: A socket – C plug with OTG function = using: data = USB version: 3.0 = packaging: 1 pc, small box



SM7054 1/-/25/100
23 35 076 012 SM7054

length: 2 m = connectors: A plug – mini B plug = using: charging/data = USB version: 2.0 = packaging: 1 pc, small box



SM7009BL 1/-/-/120
23 35 076 020 SM7009BL

length: 2 m = connectors: A plug – micro B plug = using: charging/data = USB version: 2.0 = packaging: 1 pc, small box



SM7008BL 1/-/-/120
23 35 076 021 SM7008BL

Solid, flexible cables

Solid cables CYKY-J

- round copper cables for wiring: distribution board to socket
- installation into plaster or cable channel (wall-mounted)
- contain 3 conductors (strands) with 1.5 or 2.5 mm² diameter
- tough insulation, black colour
- length: 100 m

A3004

100/-/-/100

31 16 300 400



- conductor cross section: 3× 1.5 mm²
- designation: CYKY-J
- colour: black
- packaging: 100 m, foil



A3010

100/-/-/100

31 16 301 000



- conductor cross section: 3× 2.5 mm²
- designation: CYKY-J
- colour: black
- packaging: 100 m, foil



Flexible cables PVC CYSY

- round copper cables for interiors
- ideal for appliances such as fridges, washing machines etc.
- contain 3 conductors with 1 or 1.5 mm² diameter
- soft insulation, white colour
- length: 100 m

A3366

100/-/-/100

31 16 336 600



- conductor cross section: 3× 1.0 mm²
- designation: H05VV-F
- colour: white
- packaging: 100 m, foil



A3369

100/-/-/100

31 16 336 900



- conductor cross section: 3× 1.5 mm²
- designation: H05VV-F
- colour: white
- packaging: 100 m, foil



Solar cables

- designed for fixed photovoltaic installations in indoor and outdoor areas
- tinned OFC copper core
- double jacket made of cross-linked copolymer
- resistant to mechanical damage
- TÜV Rheinland certification

S9401 23 15 094 010  8 592920 118962	500/-/-/500 H1Z2Z2 BLACK 4MM		S9402 23 15 094 020  8 592920 118979	500/-/-/500 H1Z2Z2 RED 4MM	
<ul style="list-style-type: none"> ▪ conductor cross section: 1× 4.0 mm² ▪ designation: H1Z2Z2 ▪ colour: black ▪ packaging: 500 m, wooden drum 	<ul style="list-style-type: none"> ▪ conductor cross section: 1× 4.0 mm² ▪ designation: H1Z2Z2 ▪ colour: red ▪ packaging: 500 m, wooden drum 				
S9403 23 15 094 030  8 592920 118986	500/-/-/500 H1Z2Z2 BLACK 6MM		S9404 23 15 094 040  8 592920 118993	500/-/-/500 H1Z2Z2 RED 6MM	
<ul style="list-style-type: none"> ▪ conductor cross section: 1× 6.0 mm² ▪ designation: H1Z2Z2 ▪ colour: black ▪ packaging: 500 m, wooden drum 	<ul style="list-style-type: none"> ▪ conductor cross section: 1× 6.0 mm² ▪ designation: H1Z2Z2 ▪ colour: red ▪ packaging: 500 m, wooden drum 				

HF signal receiving components, antennas, small electronic, accessories



Antennas

CITY



- for installation in places with sufficient signal quality
- fitted with LTE filter for mobile interference suppression
- selected models include a 5G filter
- reception in horizontal or vertical polarisation

use: indoor = suitable for reception from multiple transmitters = signal reception: FM/DAB/DVB-T/T2 = suitable for receiving Full HD broadcasts = gain control = LTE filter = 5G filter = polarization: horizontal or vertical = frequency bands: FM/VHF/DAB/UHF = frequency range: 47-230 MHz, 470-698 MHz = reception angle: 360° = power supply: DC USB 5 V/550 mA (included) = connectors in the package: 1 pc = connectors: IEC = length of coaxial cable in the package: 1.5 m = dimensions: 128 × 240 × 230 mm = packaging: 1 pc, box



J0701

27 02 031 000

1/-/-/10

RING-C550

use: indoor = suitable for reception from multiple transmitters = signal reception: DAB/DVB-T/T2 = suitable for receiving Full HD broadcasts = LTE filter = 5G filter = polarization: horizontal or vertical = frequency bands: VHF/UHF = frequency range: 174-230 MHz, 470-698 MHz = reception angle: 360° = power supply: DC USB 5 V/550 mA (included) = connectors in the package: 1 pc = connectors: IEC = length of coaxial cable in the package: 2 m = dimensions: 8 × 345 × 77 mm = packaging: 1 pc, box



J0703

27 02 033 000

1/-/-/20

ARCH-C200

use: indoor = suitable for reception from multiple transmitters = signal reception: DAB/DVB-T/T2 = suitable for receiving Full HD broadcasts = gain control = LTE filter = 5G filter = polarization: horizontal or vertical = frequency bands: VHF/DAB/UHF = frequency range: 174-230 MHz, 470-698 MHz = reception angle: 360° = power supply: DC USB 5 V/550 mA (included) = connectors in the package: 1 pc = connectors: IEC = length of coaxial cable in the package: 1.5 m = dimensions: 200 × 40 × 230 mm = packaging: 1 pc, box



J0704 1/-/-/10
27 02 034 000 RING-C500

use: indoor = suitable for reception from multiple transmitters = signal reception: FM/DAB/DVB-T/T2 = suitable for receiving Full HD broadcasts = gain control = LTE filter = 5G filter = polarization: horizontal or vertical = frequency bands: FM/VHF/DAB/UHF = frequency range: 87.5-230 MHz, 470-698 MHz = reception angle: 180° = power supply: DC USB 5 V/550 mA (included) = connectors in the package: 1 pc = connectors: IEC = length of coaxial cable in the package: 1.5 m = dimensions: 110 × 290 × 220 mm = packaging: 1 pc, box



J0705 1/-/-/10
27 02 035 000 ORBI-C200

use: indoor = suitable for reception from multiple transmitters = signal reception: FM/DAB/DVB-T/T2 = suitable for receiving Full HD broadcasts = LTE filter = 5G filter = polarization: horizontal or vertical = frequency bands: FM/VHF/DAB/UHF = frequency range: 87.5-230 MHz, 470-698 MHz = reception angle: 360° = power supply: USB 5 V/200 mA (included) = connectors in the package: IEC = length of coaxial cable in the package: 1.85 m = dimensions: 300 × 80 × 45 mm = packaging: 1 pc, box



J0708 1/-/-/20
27 02 038 000 WOOD-C500

use: indoor = suitable for reception from multiple transmitters = signal reception: DAB/DVB-T/T2 = suitable for receiving Full HD broadcasts = LTE filter = 5G filter = polarization: horizontal or vertical = frequency bands: VHF/UHF = frequency range: 174-230 MHz, 470-698 MHz = reception angle: 180° = power supply: USB 5 V/200 mA (included) = connectors: IEC = dimensions: 1.3 × 228 × 128 mm = packaging: 1 pc, box



J0709 1/-/-/22
27 02 039 000 LEAF-C600

VILLAGE



- for places with weaker signal (further from transmitter)
- fitted with LTE filter for mobile interference suppression
- can be installed in horizontal or vertical polarisation

use: indoor/outdoor = suitable for long distance reception = suitable for reception from multiple transmitters = signal reception: DVB-T/T2 = suitable for receiving Full HD broadcasts = gain control = LTE filter = 5G filter = polarization: horizontal or vertical = frequency bands: UHF = frequency range: 470–698 MHz = reception angle: 90° = power supply: DC USB 5 V/550 mA (included) = connectors in the package: 2 pc = connectors: F, IEC = length of coaxial cable in the package: 8.5 m = dimensions: 230 × 325 × 20 mm = packaging: 1 pc, box



J0801 1/-/-/10
27 04 310 000 DIO-V750

use: indoor/outdoor = suitable for long distance reception = suitable for reception from multiple transmitters = signal reception: FM/DAB/DVB-T/T2 = suitable for receiving Full HD broadcasts = LTE filter = 5G filter = polarization: horizontal or vertical = frequency bands: FM/VHF/DAB/UHF = frequency range: 87.5–230 MHz, 470–698 MHz = reception angle: 180° = power supply: USB 5 V/200 mA (included) = connectors in the package: 2 pc = connectors: IEC = length of coaxial cable in the package: 5 m = dimensions: 230 × 80 × 120 mm = packaging: 1 pc, box



J0802 1/-/-/10
27 04 320 000 CAMP-V400

use: indoor/outdoor = suitable for long distance reception = suitable for reception from multiple transmitters = signal reception: DVB-T/T2 = suitable for receiving Full HD broadcasts = LTE filter = 5G filter = polarization: horizontal or vertical = frequency bands: UHF = frequency range: 470–698 MHz = number of elements: 10 = reception angle: 30°/40° = power supply: DC USB 5 V/550 mA (included) = connectors: F, IEC = length of coaxial cable in the package: 5 m = dimensions: 315 × 215 × 200 mm = packaging: 1 pc, box



J0685 1/-/-/8
27 02 029 000 EM-D103

use: indoor/outdoor = suitable for long distance reception = suitable for reception from multiple transmitters = signal reception: FM/DAB/DVB-T/T2 = suitable for receiving Full HD broadcasts = LTE filter = 5G filter = polarization: horizontal or vertical = frequency bands: FM/VHF/UHF = frequency range: 47–698 MHz = reception angle: 360° = power supply: USB 5 V/200 mA (included) = connectors: IEC = length of coaxial cable in the package: 5 m = dimensions: 300 × 40 mm = packaging: 1 pc, box



J0803 1/-/-/2
27 04 330 000 MOON-V900



www.emos.eu

Order Code
Item Number

Packaging
Type

use: indoor/outdoor = suitable for long distance reception = suitable for reception from multiple transmitters = signal reception: DAB/DVB-T/T2 = suitable for receiving Full HD broadcasts = gain control = LTE filter = 5G filter = polarization: horizontal or vertical = frequency bands: VHF/DAB/UHF = frequency range: 174–230 MHz, 470–698 MHz = reception angle: 180° = power supply: DC USB 5 V/550 mA (included) = connectors in the package: 2 pc = connectors: F, IEC = length of coaxial cable in the package: 8.5 m = dimensions: 40 × 130 × 320 mm = packaging: 1 pc, box



J0804
27 04 340 000

1/-/-2
FLIPP-V200

use: outdoor = suitable for long distance reception = signal reception: DVB-T/T2 = suitable for receiving Full HD broadcasts = LTE filter = 5G filter = polarization: horizontal or vertical = frequency bands: UHF = frequency range: 470–698 MHz = number of elements: 20 = reception angle: 30°/40° = power supply: DC 5–12 V/100 mA (included) = connectors in the package: 1 pc = connectors: F connector = length of coaxial cable in the package: 10 m = dimensions: 400 × 39 × 330 mm = packaging: 1 pc, box



J0806
27 04 350 000

1/-/-1
FISH-V700

PROFI



- for places with low signal strength (far away from transmitter)
- selected models include a 5G filter
- reception in horizontal or vertical polarisation

- use: outdoor YAGI
- suitable for long distance reception
- signal reception: DVB-T/T2
- suitable for receiving Full HD broadcasts
- LTE filter
- 5G filter
- polarization: horizontal or vertical
- frequency bands: UHF
- frequency range: 470–698 MHz

- number of elements: 16
- reception angle: 38°/80°
- connectors in the package: 1 pc
- connectors: F connector
- dimensions: 790 × 510 × 440 mm
- packaging: 1 pc, box



J0906
27 04 560 000

1/-/-6
EM-P117

- use: outdoor YAGI
- suitable for long distance reception
- signal reception: DVB-T/T2
- suitable for receiving Full HD broadcasts
- LTE filter
- 5G filter
- polarization: horizontal or vertical
- frequency bands: UHF
- frequency range: 470–698 MHz

- number of elements: 27
- reception angle: 38°/80°
- connectors in the package: 1 pc
- connectors: F connector
- dimensions: 1060 × 580 × 600 mm
- packaging: 1 pc, box



J0907
27 04 570 000

1/-/-6
EM-P127

- use: outdoor
- suitable for long distance reception
- suitable for reception from multiple transmitters
- signal reception: DVB-T/T2
- suitable for receiving Full HD broadcasts
- LTE filter
- 5G filter
- polarization: horizontal or vertical
- frequency bands: UHF

- frequency range: 470–698 MHz
- number of elements: 29
- reception angle: 38°/80°
- power supply: passive
- connectors: F connector
- dimensions: 1 150 × 520 × 640 mm
- packaging: 1 pc, box



J0690 1/-/-/4
27 04 039 000 EM-29U5G

- use: outdoor
- suitable for long distance reception
- signal reception: DVB-T/T2
- suitable for receiving Full HD broadcasts
- LTE filter
- 5G filter: no
- polarization: horizontal or vertical
- frequency bands: UHF
- frequency range: 470–790 MHz

- number of elements: 26
- reception angle: 45°/40°
- power supply: passive
- connectors: F connector
- dimensions: 940 × 315 × 38 mm
- packaging: 1 pc, box



J0669 1/-/-/1
27 04 280 010 EM-2845

- use: outdoor
- suitable for long distance reception
- signal reception: DVB-T/T2
- suitable for receiving Full HD broadcasts
- LTE filter
- 5G filter: no
- polarization: horizontal or vertical
- frequency bands: UHF
- frequency range: 470–790 MHz

- number of elements: 16
- reception angle: 34°/26°
- power supply: passive
- connectors: F connector
- dimensions: 1000 × 360 × 340 mm
- packaging: 1 pc, header card



J0680 1/-/-/1
27 04 030 000 EM-116

- use: outdoor logarithmic-periodical
- suitable for long distance reception
- suitable for reception from multiple transmitters
- signal reception: DAB/DVB-T/T2
- suitable for receiving Full HD broadcasts
- LTE filter
- 5G filter: no
- polarization: horizontal or vertical
- frequency bands: VHF/DAB/UHF

- frequency range: 170–790 MHz
- reception angle: 30°/40°
- power supply: 12 V/100 mA (included)
- connectors: F connector
- dimensions: 178 × 560 × 780 mm
- packaging: 1 pc, box



J0665 1/-/-/1
27 03 105 000 EM-025

- use: outdoor logarithmic-periodical
- suitable for long distance reception
- suitable for reception from multiple transmitters
- signal reception: DAB/DVB-T/T2
- suitable for receiving Full HD broadcasts
- LTE filter
- 5G filter: no
- polarization: horizontal or vertical
- frequency bands: VHF/DAB/UHF

- frequency range: 170–790 MHz
- reception angle: 30°/40°
- power supply: 12 V/100 mA (included)
- connectors: F connector
- dimensions: 178 × 560 × 780 mm
- packaging: 1 pc, box



J0666 1/-/-/1
27 03 106 000 EM-030

TV signal receivers

TV signal receivers

- certified set-top boxes
- for reception of digital terrestrial DVB-T2 broadcasting
- full support for DVB-T2 in HEVC and H.265 standard
- numerous outlets and plugs: USB, HDMI, SCART, IEC
- recording and playing programmes to/from USB
- timeshift, parent lock, remote control with long range
- multilingual menu, automatic and manual tuning

DVB-T/DVB-T2 : DVB-T2 = connectors: 1× USB 2.0, 1× HDMI 1.4, 1× miniUSB, 1× IEC, 1× SCART = tuner frequency range: 174–230MHz, 474–860 MHz = input level of signal: -75.2 to -23.9 dBm = update via USB: yes = PVR recording function: yes, via USB up to 1 TB = recording format: TS free to be reproduced = file format on USB device: FAT16, FAT32, NTFS = EPG program guide: 7 days = power supply: 220–240 V AC 50/60 Hz = consumption (on/stand-by): 5 W/<1 W = dimensions: 120 × 75 × 25 mm = packaging: 1 pc, box



J6014 1/-/-/20
25 20 236 400 EM190-S HD

Accessories

J50988 1/-/-/200
25 20 900 088 D.O. EM190 / EM190S



designed for: EM190/EM190S/EM190L = learning function = code remembered after removing the battery = range: 15 m = power source: 2× AAA = dimensions: 175 × 45 × 15 mm = weight: 100 g = packaging: 1 pc, PVC packet

J50989 1/-/-/220
25 20 900 089 D.O. EM190/EM190S S



designed for: EM190/EM190S/EM190L = learning function = code remembered after removing the battery = range: 15 m = power source: 2× AAA = dimensions: 170 × 55 × 20 mm = weight: 100 g = packaging: 1 pc, PVC packet

Wall sockets

- homologated components for professionals and DIY
- quality materials ensure outstanding technical properties
- designed for processing and transmitting digital signal

- version: terminal
- designation: TV (2) + R (2) + SAT (3)
- terminal attenuation: 3 dB
- connector type: IEC + F (female)
- dimensions: 26 × 60 × 60 mm
- packaging: 1 pc, box



J0240
25 01 000 300

1/-/-/60
EU3303

- version: terminal
- designation: TV (2) + R (2) + SAT (3)
- terminal attenuation: 3 dB
- connector type: IEC + F (female)
- dimensions: 26 × 60 × 60 mm
- packaging: 1 pc, box



J0240E
25 01 000 330

1/-/-/100
EU3303E

- version: loop-through
- designation: TV (7) + R (7) + SAT (10)
- terminal attenuation: 7 dB
- insertion loss: 3 dB
- connector type: IEC + F (female)
- dimensions: 26 × 60 × 60 mm
- packaging: 1 pc, box



J0260
25 01 000 400

1/-/-/60
EU3407

- version: terminal
- designation: TV (3.5) + R (4)
- terminal attenuation: 3 dB
- connector type: IEC
- dimensions: 26 × 60 × 60 mm
- packaging: 1 pc, box



J0200
25 01 000 100

1/-/-/60
EU3503

- version: terminal
- designation: TV (1) + R (2)
- terminal attenuation: 1 dB
- connector type: IEC
- dimensions: 26 × 60 × 60 mm
- packaging: 1 pc, box



J0203

1/-/-/60

25 01 000 200

EU3601P

- version: loop-through
- designation: TV (7) + R (7)
- terminal attenuation: 7 dB
- insertion loss: 3 dB
- connector type: IEC
- dimensions: 26 × 60 × 60 mm
- packaging: 1 pc, box



J0220J

1/-/-/60

25 01 100 100

EU3607

- version: loop-through
- designation: TV (14) + R (14)
- terminal attenuation: 14 dB
- insertion loss: 1.5 dB
- connector type: IEC
- dimensions: 26 × 60 × 60 mm
- packaging: 1 pc, box



J0222

1/-/-/60

25 01 100 300

EU3614

Accessories

Combiners, splitters

- merge terrestrial and satellite broadcasting signal
- or terrestrial signal from 2 antennas
- divided by enclosure rating: indoor (IP20) or outdoor (IP53)
- split signal to up to 4 outputs (F or IEC connectors)
- selected types feature power pass for DC voltage

- product: signal combiner SAT+TV
- inputs: 2
- outputs: 1
- connectors: IEC
- frequency range: 0.1-1 000 MHz
- insertion loss: 3.5 dB
- power pass
- body material: zinc casting
- working temperature: -10-+65 °C

- using: TV + R
- IP rating: IP20
- dimensions: 17 × 32 × 23 mm
- packaging: 1 pc, PVC packet



J0197 1/-/10/200
25 03 000 100 EU2491

- product: signal combiner SAT+TV
- inputs: 2
- outputs: 1
- suitable for merging of satellite signals
- connectors: F female
- frequency range: 5-2 400 MHz
- insertion loss: 3.5 dB
- power pass: yes, SAT
- body material: zinc casting

- working temperature: -10-+65 °C
- using: TV + R + SAT
- IP rating: IP53
- dimensions: 25 × 35 × 20 mm
- packaging: 1 pc, PVC packet



J0198 1/-/10/200
25 03 000 400 TV+SAT
COMBINER

- product: splitter
- number of inputs: 1
- number of outputs: 2
- connectors: IEC
- frequency range: 0.1-1 000 MHz
- insertion loss: 3.5 dB
- power pass
- hub body material: zinc casting
- working temperature: -10-+65 °C

- using: TV + R
- IP rating: IP20
- dimensions: 17 × 32 × 23 mm
- packaging: 1 pc, header card



J0199 1/-/10/200
25 04 200 100 EU2501



www.emos.eu

Order Code
Item Number

Packaging
Type

- number of inputs: 1
- number of outputs: 2
- connectors: F female
- frequency range: 5-2 400 MHz
- insertion loss: 3.7 dB
- power pass: yes, 2*
- hub body material: zinc casting
- working temperature: -10--+65 °C
- using: TV + R

- IP rating: IP20
- dimensions: 25 × 35 × 20 mm
- packaging: 1 pc, box



J0102 1/-/10/200
25 04 500 110 EM2342

- number of inputs: 1
- number of outputs: 3
- connectors: F female
- frequency range: 5-2 400 MHz
- insertion loss: 6 dB
- power pass: yes, 3*
- hub body material: zinc casting
- working temperature: -10--+65 °C
- using: TV + R + SAT

- IP rating: IP20
- dimensions: 20 × 56 × 25 mm
- packaging: 1 pc, box



J0103 1/-/10/200
25 04 600 110 EM2343

- number of inputs: 1
- number of outputs: 4
- connectors: F female
- frequency range: 5-2 400 MHz
- insertion loss: 7.5 dB
- power pass: yes, 4*
- hub body material: zinc casting
- working temperature: -10--+65 °C
- using: TV + R + SAT

- IP rating: IP20
- dimensions: 20 × 56 × 25 mm
- packaging: 1 pc, box



J0104 1/-/10/200
25 04 700 110 EM2344

Amplifiers, preamplifiers, LTE filters

- amplification: 20-30 dB, F connectors (in & out), IP45
- built-in LTE filter 790 MHz suppresses mobile interference
- LTE filter can also be purchased extra (for older antennas)

product: antenna preamplifier = inputs: 1 = number of outputs: 1 = frequency range: 5-260 MHz, 470-790 MHz
 = gain: 25 dB = noise figure: <3.0 dB = connectors: F female = IP rating: IP45 = hole spacing: 27 mm = power supply: 12 V/50 mA = dimensions: 12 × 44 × 40 mm = packaging: 1 pc, PVC packet



J5802 1/-/10/200
25 07 100 600 BEN-25



www.emos.eu

Order Code
Item Number

Packaging
Type

product: antenna preamplifier = inputs: 1 = number of outputs: 1 = frequency range: 5-260 MHz, 470-790 MHz = gain: 30 dB = noise figure: <3.0 dB = connectors: F female = IP rating: IP45 = hole spacing: 27 mm = power supply: 12 V/50 mA = dimensions: 12 x 44 x 40 mm = packaging: 1 pc, PVC packet



J5803 1/-/10/200
25 07 100 700 BEN-30

product: shielded line amplifier = inputs: 1 = number of outputs: 1 = frequency range: 470-790 MHz = stop band: 790-2 200 MHz = gain: 20 dB = noise figure: <2.0 dB = maximum output signal level: 104 dBµV = connectors: F female = IP rating: IP45 = power supply: 5-12 V DC, 65 mA = dimensions: 20 x 42 mm = packaging: 1 pc, header card



J5709 1/-/10/200
25 08 000 810 AMP-20/5-12

product: shielded line amplifier = inputs: 1 = number of outputs: 1 = frequency range: 470-790 MHz = stop band: 790-2 200 MHz = gain: 30 dB = noise figure: <2.0 dB = maximum output signal level: 104 dBµV = connectors: F female = IP rating: IP45 = power supply: 5-12 V DC, 65 mA = dimensions: 20 x 42 mm = packaging: 1 pc, header card



J5710 1/-/10/200
25 08 000 900 AMP-30 5-12V

product: broadband home amplifier = inputs: 1 = number of outputs: 2 = frequency range: 47-230 MHz, 470-698 MHz = stop band: 400-470 MHz, 699-2 200 MHz = gain: 25 dB = gain control: 0-15 dB = noise figure: <3.0 dB = maximum output signal level: 108 dBµV = connectors: F female = IP rating: IP20 = power supply: 230 V +/-10 %, 50/60 Hz, 3 W = dimensions: 105 x 135 x 40 mm = packaging: 1 pc, box



J0400 1/-/-/40
25 06 000 800 EM440

product: 5G filter = inputs: 1 = number of outputs: 1 = frequency range: 0.3-694 MHz = stop band: 700-2 400 MHz = attenuation in the stop band: >40 dB = connectors: F female = IP rating: IP20 = power pass: yes, 300 mW = dimensions: 16 x 40 mm = packaging: 1 pc, box



J5711 1/-/10/200
25 08 100 100 EM694F



www.emos.eu

Order Code
Item Number

Packaging
Type

product: 5G filter = inputs: 1 = number of outputs: 1 = frequency range: 0.3–694 MHz = stop band: 700–2 400 MHz = attenuation in the stop band: >40 dB = connectors: IEC connector = IP rating: IP20 = power pass: yes, 300 mA = dimensions: 16 × 68 mm = packaging: 1 pc, box



J5712	1/-/10/200
25 08 100 200	EM694IEC

Power supply units for antennas

- for powering antenna preamps and splitters, with duplexer
- output voltage: 12 V/300 mA or 12 V/100 mA, F/IEC connector
- power cable length: 1.5 m

- version: SMPS switched
- designed for: power supply of antenna preamplifiers
- power supply: 110–230 V
- output voltage: 12 V
- output current: 300 mA
- ECO design
- standby power consumption: <0.3 W
- power supply shunt
- input connector of the power injector: F connector

- output connector of the power injector: IEC
- power cable: 1.5 m
- dimensions: 70 × 57 × 23 mm
- packaging: 1 pc, box



J5810	1/-/-/80
17 02 010 035	EM-12SP

- version: SMPS switched
- designed for: power supply of antenna preamplifiers
- power supply: 110–230 V
- output voltage: 12 V
- output current: 100 mA
- ECO design
- standby power consumption: <0.3 W
- power supply shunt
- input connector of the power injector: F connector



- output connector of the power injector: F connector
- power cable: 1.5 m
- dimensions: 24 × 68 × 35 mm
- packaging: 1 pc, box





J58133	1/-/-/70
17 02 010 034	BEN-712A



Holders for satellite, terrestrial antennas



- mounts for TV, Internet and parabolic satellite antennas
- for mounting onto a wall, mast or balcony railing
- length: 250–500 mm, diameter: 28–40 mm, height: 150–630 mm
- galvanised surface protects against rust



J60030	1/-/-/1	
25 21 000 030	V30G	
		
<p>holder type: holder with crossing for the antennas = length from the base: 250 mm = finishing of the surface: galvanization = pipe diameter: 28 mm = height: 630 mm = mounting adapted to: wall = packaging: 1 pc, no packaging</p>		

J60110	1/-/-/100	
25 21 000 110	V110G	
		
<p>holder type: holder basic = length from the base: 250 mm = finishing of the surface: galvanization = pipe diameter: 28 mm = height: 130 mm = mounting adapted to: wall = packaging: 1 pc, no packaging</p>		

J60120	1/-/-/1	
25 21 000 120	V120G	
		
<p>holder type: holder with crossing = length from the base: 250 mm = finishing of the surface: galvanization = pipe diameter: 40 mm = height: 150 mm = mounting adapted to: wall = packaging: 1 pc, no packaging</p>		

J60130	1/-/-/1	
25 21 000 130	V130G	
		
<p>holder type: holder with crossing = length from the base: 350 mm = finishing of the surface: galvanization = pipe diameter: 40 mm = height: 150 mm = mounting adapted to: wall = packaging: 1 pc, no packaging</p>		

J60140	1/-/-/1	
25 21 000 140	V140G	
		
<p>holder type: holder with crossing = length from the base: 500 mm = finishing of the surface: galvanization = pipe diameter: 40 mm = height: 150 mm = mounting adapted to: wall = packaging: 1 pc, no packaging</p>		

J60170	1/-/-/1	
25 21 000 170	V170G	
		
<p>holder type: pole holder = length from the base: 350 mm = finishing of the surface: galvanization = pipe diameter: 40 mm = height: 150 mm = mounting adapted to: mast = packaging: 1 pc, no packaging</p>		

ZigBee GoSmart



- To expand the smart home with additional sensors and products
- Allows automation settings for added sensors and products
- Communication protocols Wi-Fi/Zigbee 3.0/BLE/SigMesh
- Compatibility with EMOS GoSmart products and TUYA devices



- product: IP gateway
 - connectivity: 2.4 GHz WIFI
 - maximum number of connected clients: 50
 - compatibility: EMOS GoSmart, TUYA, LIDL, Smartlife
 - protocol: Wi-Fi/Zigbee 3.0/BLE/SigMesh
 - pairing: automatic, manual
 - use: automation
 - number of control buttons: 1
 - power supply: 5 V DC/1.0 A
- supported OS: Android, iOS



H5001 1/-/-/120
30 69 050 010 IP-1000Z

- product: ZigBee repeater
- connectivity: 2.4 GHz WIFI
- compatibility: EMOS GoSmart, TUYA, LIDL, Smartlife
- protocol: Zigbee 3.0
- pairing: automatic, manual
- use: automation
- power supply: 5 V DC/1.0 A
- supported OS: Android, iOS



H5022 1/-/-/60
30 69 052 030 IP-2213Z





Videophones, doorbells

Home videophones, sets

Home videophones

- part of modern household security
- kit consists of camera and monitor with intuitive controls
- expandable with extra inputs, screens or CCTV cameras
- gate control from inside the house, touch/mechanical keys
- higher class videophones also w/ photographic memory/Wi-Fi
- white or infrared camera illumination ensures night vision
- colour display, up to 16 ringtones, power supply included

product: video set = screen size: 7" = possibility to record = lock control = gate control = intercom = power supply for the screen: 12 V DC (included) = optional connection of CCTV camera = monitor size: 175 × 125 × 20 mm = dimensions of the camera unit: 135 × 50 × 25 mm = camera viewing angle: 160° = packaging: 1 pc, box



H3010 1/-/-/6
30 10 003 010 EM-10AHD

screen size: 7" = lock and gate control = intercom = power supply for the monitor: 12 V DC (included) = recommended camera unit: H3016, H3017, H3018 = monitor size: 175 × 125 × 20 mm = packaging: 1 pc, box



H3015 1/-/-/21
30 10 003 015 EM-10AHD

product: camera unit with RFID = number of buttons on the camera unit: 1 = power supply: via monitor = number of wires (monitor/lock/power supply): 4/2/0 = dimensions of the camera unit: 131 × 47 × 18 mm = IP rating: IP44 = camera viewing angle: 160° = door lock control = installation: surface = packaging: 1 pc, box



H3016 1/-/-/20
30 10 003 016 EM-10AHD RF-1

product: camera unit with RFID = number of buttons on the camera unit: 2 = power supply: via monitor = number of wires (monitor/lock/power supply): 2× 4/2/0 = dimensions of the camera unit: 131 × 47 × 18 mm = IP rating: IP44 = camera viewing angle: 160° = door lock control = installation: surface = packaging: 1 pc, box



H3017 1/-/-/20
30 10 003 017 EM-10AHD RF-2

product: camera unit with RFID = number of buttons on the camera unit: 4 = power supply: via monitor = number of wires (monitor/lock/power supply): 4× 4/2/0 = dimensions of the camera unit: 131 × 47 × 18 mm = IP rating: IP44 = camera viewing angle: 160° = door lock control = installation: surface = packaging: 1 pc, box



H3018 1/-/-/20
30 10 003 018 EM-10AHD RF-4

product: camera unit = number of buttons on the camera unit: 1 = power supply: via monitor = number of wires (monitor/lock/power supply): 4+0+0 = dimensions of the camera unit: 49 × 132 × 20 mm = IP rating: IP65 = camera viewing angle: 160° horizontally a 130° vertically = door lock control = installation: surface = packaging: 1 pc, box



H3019 1/-/-/20
30 10 003 019 EM-10AHD KEY-1

product: video set = screen size: 7" = lock control = gate control = power supply for the screen: 14.5 V DC (included) = monitor size: 152 × 215 × 18 mm = dimensions of the camera unit: 141 × 63 × 40 mm = camera viewing angle: 80° = packaging: 1 pc, box



H2050 1/-/-/8
30 10 002 050 H2050

product: video set = screen size: 7" = lock control = gate control = intercom = power supply for the screen: 12 V DC (included) = optional connection of CCTV camera = monitor size: 233 × 23 × 160 mm = dimensions of the camera unit: 64 × 46 × 145 mm = camera viewing angle: 80° = packaging: 1 pc, box



H2017 1/-/-/6
30 10 002 017 EM-07HD

product: sudio porter set = lock and gate control: door lock control = power supply: 12 V DC (included) = number of wires (monitor/lock/gate): 2+2+0 = dimensions of the door station: 35 × 65 × 145 mm = handset dimension: 75 × 93 × 225 mm = packaging: 1 pc, box



H1085 1/-/-/10
30 10 000 291 H1085

product: sudio porter set = lock and gate control: door lock control = power supply: 12 V DC = number of wires (monitor/lock/gate): 3+2+0 = dimensions of the door station: 116 × 199 × 40 mm = handset dimension: 75 × 93 × 225 mm = packaging: 1 pc, box



H1086 1/-/-/10
30 10 000 292 H1086

product: additional camera unit = number of buttons on the camera unit: 1 = power supply: via monitor = number of wires (monitor/lock/power supply): 4/2/0 = dimensions of the camera unit: 64 × 46 × 145 mm = IP rating: IP44 = camera viewing angle: 80° = door lock control = installation: surface = packaging: 1 pc, box



H1141 1/-/-/20
30 10 001 151 EM-07HD C-01

Videophones and video doorbells GoSmart



- Perfect access control for commercial and private properties
- Unusual activity alerts sent to mobile devices
- Two-way communication with the visitor without opening the door
- Automatic video and audio recording when motion is detected
- Night vision for perfect images in all lighting conditions
- Compatibility with EMOS GoSmart products and TUYA devices
- Voice control with Google Assistant and Amazon Alexa



product: doorphone set with WiFi = screen size: 7" = possibility to record = lock control = gate control = intercom = power supply for the screen: 12 V DC (included) = optional connection of CCTV camera = monitor size: 175 × 118 × 25 mm = dimensions of the camera unit: 142 × 44 × 21 mm = camera viewing angle: 160° = packaging: 1 pc, box = supported OS: Android, iOS = compatibility: EMOS GoSmart, TUYA, LIDL, Smartlife, open system = protocol: Wi-fi = connectivity: 2.4 GHz WIFI = voice communication: two-way



H4020

1/-/-4

30 10 040 200

IP-750A

product: video phone = screen size: 7" = lock and gate control = intercom = power supply for the monitor: 12 V DC (included) = recommended camera unit: H3016, H3017, H3018, H3019 = monitor size: 145 × 205 × 12 mm = packaging: 1 pc, box



H4021

1/-/-6

30 10 040 210

IP-750B

lock control = additional indoor bell = camera viewing angle: 110° = camera resolution: 1 920 × 1 080 = motion detection = IR CUT = siren = supported OS: Android, iOS = compatibility: EMOS GoSmart, TUYA, LIDL, Smartlife, open system = protocol: Wi-Fi = transmission frequency: 2.4 GHz WIFI = SD card storage = cloud storage = anti-theft protection = control by voice assistants = voice communication: two-way = notifications to the mobile app = WebRTC function



H4030

1/-/-8

30 10 040 300

IP-09D DC

lock control = additional indoor bell = camera viewing angle: 110° = camera resolution: 1 920 × 1 080 = motion detection = IR CUT = siren = supported OS: Android, iOS = compatibility: EMOS GoSmart, TUYA, LIDL, Smartlife, open system = protocol: Wi-Fi = transmission frequency: 2.4 GHz WIFI = SD card storage = cloud storage = anti-theft protection = control by voice assistants = voice communication: two-way = notifications to the mobile app = WebRTC function



H4031

1/-/-12

30 10 040 310

IP-09C

additional indoor bell = camera viewing angle: 130° = camera resolution: 1 920 × 1 080 = motion detection = IR CUT = supported OS: Android, iOS = compatibility: EMOS GoSmart, TUYA, LIDL, Smartlife, open system = protocol: Wi-Fi = transmission frequency: 2.4 GHz WIFI = SD card storage = cloud storage = anti-theft protection = control by voice assistants = voice communication: two-way = notifications to the mobile app = WebRTC function



H4032 1/-/-/10
30 10 040 320 IP-15S

Accessories for videophones

- electrical door controls are a key part of security systems
- often complemented by code keypads or fingerprint readers
- automatically open door lock after access verification
- keypad w/ 2 relays, built-in RFID fob reader also available
- memory capacity of up to 1 000 codes

H8013 1/100/-/700
30 80 000 013 H8013



product: RF tag = dimensions: 28 × 7 mm = packaging: 1 pc, packet = frequency: 125 kHz

C0024 1/-/-/30
28 04 000 013 C0024



product: lock = type: with mechanical unblocking for constant entry - OPEN position = power supply: 12 V AC/DC (not included) = dimensions: 25 × 28 × 250 mm = packaging: 1 pc, box

C0025 1/-/-/30
28 04 000 014 C0025



product: lock = type: with a time pin, after the electric impulse position OPENED, after passing through the door position CLOSED = power supply: 12 V AC/DC (not included) = dimensions: 25 × 28 × 250 mm = packaging: 1 pc, box

C0030 1/-/-/12
28 04 000 030 EM-0280A



product: door lock = type: EM-0280A = power supply: 12 V DC (není součástí balení) = dimensions: 250 × 25 × 32 mm = packaging: 1 pc, box

H5023 1/-/-/18
30 69 050 230 IP-006AX



product: keyboard RFID, TUYA = number of switching relays: 1 = number of codes: up to 1 000 = power source: 12 V AC/DC (not included) = dimensions: 23 × 78 × 115 mm = packaging: 1 pc, box = frequency: 125 kHz = supported OS: Android, iOS = compatibility: EMOS GoSmart, TUYA, LIDL, Smartlife, open system = protocol: Wi-Fi = transmission frequency: 2.4 GHz Wi-Fi = cloud storage

H7009 1/-/-/50
30 70 000 009 H7009



max. output total: 12 V/5 A = input voltage: 100–240 V~, 47–63 Hz = protection against overload, overvoltage and short circuit = designed for: universal = LED indicators = output voltage: 12 V DC = output current: max. 5 000 mA = power supply type: no cable = dimensions: 77 × 55 × 92 mm = packaging: 1 pc, paper box

Cameras, Surveillance

GoSmart Cameras



- For keeping people safe and protecting the interiors of homes
- Surveillance of exteriors of commercial and private buildings
- Alerts of unusual activity sent to mobile devices
- Two-way voice communication
- Automatic video and audio recording when motion is detected
- Connection to home network via WIFI protocol
- Compatibility with EMOS GoSmart products and TUYA devices
- Voice control with Google Assistant and Amazon Alexa



- automatic image saving
- setting the detection area
- night vision
- camera viewing angle: 100°
- IP rating: IP20
- camera resolution: 1 920 × 1 080
- motion detection
- sound detection
- compatibility: EMOS GoSmart, TUYA, LIDL, Smartlife
- protocol: Wi-Fi
- transmission frequency: 2.4 GHz WIFI
- voice communication: two-way
- motion tracking
- motorised rotation
- motion detection angle: 100°
- motion detection range: 10 meters



H4051
30 24 040 510

1/-/-12
IP-100 CUBE

- automatic image saving
- setting the detection area
- night vision
- camera viewing angle: 100°
- IP rating: IP20
- camera resolution: 2 304 × 1 296
- motion detection
- sound detection
- compatibility: EMOS GoSmart, TUYA, LIDL, Smartlife
- protocol: Wi-Fi
- transmission frequency: 2.4 GHz WIFI
- voice communication: two-way
- motion tracking
- motorised rotation
- motion detection angle: 100°
- motion detection range: 10 meters
- human body recognition



H4052
30 24 040 520

1/-/-6
IP-500 GUARD

- automatic image saving
- night vision
- camera viewing angle: 110°
- IP rating: IP55
- camera resolution: 1 920 × 1 080
- motion detection
- compatibility: EMOS GoSmart, TUYA, LIDL, Smartlife
- protocol: Wi-Fi
- transmission frequency: 2.4 GHz WIFI
- voice communication: two-way
- motion detection angle: 120°
- motion detection range: 10 meters
- human body recognition



H4056
30 24 040 560

1/-/-5
IP-600 EYE

- automatic image saving
- setting the detection area
- night vision
- camera viewing angle: 110°
- IP rating: IP65
- camera resolution: 2 616 × 1 958
- motion detection
- sound detection
- compatibility: EMOS GoSmart, TUYA, LIDL, Smartlife

- protocol: Wi-Fi
- transmission frequency: 2.4 GHz WIFI
- voice communication: two-way
- motion tracking
- motorised rotation
- motion detection angle: 110°
- motion detection range: 10 meters
- human body recognition



H4057 1/-/-/4
30 24 040 570 IP-800 WASP

- automatic image saving
- setting the detection area
- night vision: yes, 4× IR LED + white LED
- camera viewing angle: 105°
- IP rating: IP65
- camera resolution: 2 048 × 1 536
- motion detection
- compatibility: EMOS GoSmart, TUYA, LIDL, Smartlife
- protocol: 4G, LTE

- transmission frequency: LTE
- voice communication: two-way
- motorised rotation
- motion detection angle: 120°
- motion detection range: 10 meters
- human body recognition



H4058 1/-/-/4
30 24 040 580 IP-6000 OWL

- automatic image saving
- setting the detection area
- night vision
- camera viewing angle: 100°
- IP rating: IP20
- camera resolution: 2 304 × 1 296
- motion detection
- sound detection
- compatibility: EMOS GoSmart, TUYA, LIDL, Smartlife

- protocol: Wi-Fi
- transmission frequency: 2.4 GHz WIFI
- voice communication: two-way
- motion tracking
- motorised rotation
- motion detection angle: 100°
- motion detection range: 10 meters



H4061 1/-/-/12
30 24 040 610 IP-110 CUBEV2

- automatic image saving
- setting the detection area
- night vision: yes, 9× IR LED 850 nm
- camera viewing angle: 130°
- IP rating: IP65
- camera resolution: 2 592 × 1 944
- motion detection
- compatibility: EMOS GoSmart, TUYA, LIDL, Smartlife
- protocol: Wi-Fi

- transmission frequency: 2.4 GHz WIFI
- voice communication: two-way
- motion detection angle: 120°
- motion detection range: 9 metres
- human body recognition



H4063 1/-/-/14
30 24 040 630 IP-210 SNAPV2

- automatic image saving
- setting the detection area
- night vision: yes, 4× IR LED + white LED
- camera viewing angle: 130°
- IP rating: IP65
- camera resolution: 2 304 × 1 296
- motion detection
- compatibility: EMOS GoSmart, TUYA, LIDL, Smartlife
- protocol: Wi-Fi

- transmission frequency: 2.4 GHz WIFI
- voice communication: two-way
- motion tracking
- motorised rotation
- motion detection angle: 120°
- motion detection range: 10 meters



H4064 1/-/-/4
30 24 040 640 IP-310 TORCHV2 WHITE

- automatic image saving
- setting the detection area
- night vision: yes, 4× IR LED + white LED
- camera viewing angle: 130°
- IP rating: IP65
- camera resolution: 2 304 × 1 296
- motion detection
- compatibility: EMOS GoSmart, TUYA, LIDL, Smartlife
- protocol: Wi-Fi
- transmission frequency: 2.4 GHz WIFI
- voice communication: two-way
- motion tracking
- motorised rotation
- motion detection angle: 120°
- motion detection range: 10 meters



H4065 1/-/-/4
30 24 040 650 IP-310 TORCHV2
BLACK

Doorbells

Wireless doorbells

- EMOS doorbells have a battery- or mains-powered receiver
- paired from production/paired by user with ease in seconds
- new models with signal repeater – unlimited range
- with 1 or 2 waterproof buttons, more buttons can be added
- volume controls, optical signalisation, up to 52 ringtones

- reach of the button: 150 m
- number of melodies: 10
- pairing method: automatic pairing – self-learning
- special functions: battery-free button
- optical signaling on the doorbell
- optical signaling on the button
- maximum ringing volume: 110 dB
- option to add another button: yes, max. 8
- number of buttons in a package: 1 pc
- extra (spare) button: P5750T
- waterproof button: IP44
- power button: unpowered
- number of receivers in a package: 1 pc
- volume control: yes, 5 levels
- power supply of the main unit: 230 V AC



P5750 1/-/-/14
34 02 118 000 P5750

- reach of the button: 150 m
- number of melodies: 10
- pairing method: automatic pairing – self-learning
- special functions: battery-free button
- optical signaling on the doorbell
- optical signaling on the button
- maximum ringing volume: 110 dB
- option to add another button: yes, max. 8
- number of buttons in a package: 2 pcs
- extra (spare) button: P5750T
- waterproof button: IP44
- power button: unpowered
- number of receivers in a package: 1 pc
- volume control: yes, 5 levels
- power supply of the main unit: 230 V AC



P5750.2T 1/-/-/8
34 02 119 000 P5750.2T

- reach of the button: 150 m
- number of melodies: 10
- pairing method: automatic pairing – self-learning
- special functions: battery-free button
- optical signaling on the doorbell
- optical signaling on the button
- maximum ringing volume: 110 dB
- option to add another button: yes, max. 8
- number of buttons in a package: 1 pc
- extra (spare) button: P5750T
- waterproof button: IP44
- power button: unpowered
- number of receivers in a package: 2 pcs
- volume control: yes, 5 levels
- power supply of the main unit: 230 V AC



P5750.2R 1/-/-/8
34 02 120 000 P5750.2R



- reach of the button: 120 m
- number of melodies: 16
- pairing method: automatic pairing – self-learning
- special functions: USB output – 2 A, repeater functi
- optical signaling on the doorbell
- optical signaling on the button
- maximum ringing volume: 85 dB
- option to add another button: yes, max. 8
- number of buttons in a package: 1 pc
- extra (spare) button: P5760T
- waterproof button: IP44
- power button: 1× 3 V CR2032 (included)
- number of receivers in a package: 1 pc
- volume control: yes, 5 levels
- power supply of the main unit: 230 V AC



P5760 1/-/5/10
34 02 060 000 P5760



- reach of the button: 120 m
- number of melodies: 16
- pairing method: automatic pairing – self-learning
- special functions: repeater function – allows extend
- optical signaling on the doorbell
- optical signaling on the button
- maximum ringing volume: 85 dB
- option to add another button: yes, max. 8
- number of buttons in a package: 1 pc
- extra (spare) button: P5760T
- waterproof button: IP44
- power button: 1× 3 V CR2032 (included)
- number of receivers in a package: 1 pc
- volume control: yes, 5 levels
- power supply of the main unit: 3× 1.5 V AA (not inclu



P5763 1/-/5/10
34 02 060 001 P5763



- reach of the button: 120 m
- number of melodies: 16
- pairing method: automatic pairing – self-learning
- special functions: repeater function – allows extend
- optical signaling on the doorbell
- optical signaling on the button
- maximum ringing volume: 85 dB
- option to add another button: yes, max. 8
- extra (spare) button: P5760T
- power button: 1× 3 V CR2032 (included)
- number of receivers in a package: 1 pc
- volume control: yes, 5 levels
- power supply of the main unit: 3× 1.5 V AA (not inclu



P5763R 1/-/5/15
34 02 063 000 P5763R



- reach of the button: 150 m
- number of melodies: 36
- pairing method: automatic pairing – self-learning
- optical signaling on the button
- maximum ringing volume: 85 dB
- option to add another button: yes, max. 6
- number of buttons in a package: 1 pc
- extra (spare) button: P5727T
- waterproof button: IP44
- power button: 1× 3 V CR2032 (included)
- number of receivers in a package: 1 pc
- volume control: yes, 4 levels
- power supply of the main unit: 230 V AC



P5727 1/-/-/8
34 02 025 000 P5727



- reach of the button: 60 m
- number of melodies: 1
- pairing method: automatic pairing – self-learning
- optical signaling on the doorbell
- optical signaling on the button
- maximum ringing volume: 75 dB
- option to add another button: yes, max. 8
- number of buttons in a package: 1 pc
- extra (spare) button: P5723T

- waterproof button: IP44
- power button: 1× 3 V CR2032 (included)
- number of receivers in a package: 1 pc
- power supply of the main unit: 230 V AC



P5705 1/-/4/12
34 02 005 000 98080S



- reach of the button: 100 m
- number of melodies: 16
- pairing method: automatic pairing – self-learning
- optical signaling on the doorbell
- optical signaling on the button
- maximum ringing volume: 80 dB
- option to add another button: yes, max. 8
- number of buttons in a package: 1 pc
- extra (spare) button: P5723T

- waterproof button: IP44
- power button: 1× 3 V CR2032 (included)
- number of receivers in a package: 1 pc
- volume control
- power supply of the main unit: 3× 1.5 V AA (not inclu)



P5712 1/-/5/40
34 02 012 000 9810S



- reach of the button: 100 m
- number of melodies: 36
- pairing method: automatic pairing – self-learning
- optical signaling on the button
- maximum ringing volume: 75 dB
- option to add another button: yes, max. 8
- number of buttons in a package: 1 pc
- extra (spare) button: P5723T
- waterproof button: IP44

- power button: 1× 3 V CR2032 (included)
- number of receivers in a package: 1 pc
- power supply of the main unit: 3× 1.5 V AA (not inclu)



P5723 1/3/-/48
34 02 107 000 9809S



- reach of the button: 180 m
- number of melodies: 52
- pairing method: automatic pairing – self-learning
- optical signaling on the doorbell
- optical signaling on the button
- maximum ringing volume: 90 dB
- option to add another button: yes, max. 6
- number of buttons in a package: 1 pc
- extra (spare) button: P5728T

- waterproof button: IP56
- power button: 1× 12 V A23 (included)
- number of receivers in a package: 1 pc
- volume control: yes, 5 levels
- power supply of the main unit: 3× 1.5 V AAA (not inc)



P5728 1/-/-/30
34 02 043 000 P5728



- reach of the button: 180 m
- number of melodies: 52
- pairing method: automatic pairing – self-learning
- optical signaling on the doorbell
- optical signaling on the button
- maximum ringing volume: 90 dB
- option to add another button: yes, max. 6
- number of buttons in a package: 1 pc
- extra (spare) button: P5728T

- waterproof button: IP56
- power button: 1× 12 V A23 (included)
- number of receivers in a package: 2 pcs
- volume control: yes, 5 levels
- power supply of the main unit: 3× 1.5 V AAA (not inc)



P5730 1/-/-/12
34 02 115 000 P5730



- reach of the button: 180 m
- number of melodies: 36
- pairing method: automatic pairing – self-learning
- special functions: battery-free button
- optical signaling on the doorbell
- optical signaling on the button
- maximum ringing volume: 90 dB
- option to add another button: yes, max. 6
- number of buttons in a package: 1 pc
- extra (spare) button: P5729T
- waterproof button: IP44
- power button: unpowered
- number of receivers in a package: 1 pc
- volume control: yes, 4 levels
- power supply of the main unit: 230 V AC



P5729 1/-/-/14
34 02 044 000 P5729



- reach of the button: 180 m
- number of melodies: 36
- pairing method: automatic pairing – self-learning
- special functions: battery-free button
- optical signaling on the doorbell
- optical signaling on the button
- maximum ringing volume: 90 dB
- option to add another button: yes, max. 6
- number of buttons in a package: 1 pc
- extra (spare) button: P5729T
- waterproof button: IP44
- power button: unpowered
- number of receivers in a package: 2 pcs
- volume control: yes, 4 levels
- power supply of the main unit: 230 V AC



P5731 1/-/-/8
34 02 116 000 P5731



- reach of the button: 180 m
- number of melodies: 36
- pairing method: automatic pairing – self-learning
- special functions: battery-free button
- optical signaling on the doorbell
- optical signaling on the button
- maximum ringing volume: 90 dB
- option to add another button: yes, max. 6
- number of buttons in a package: 1 pc
- extra (spare) button: P5729T
- waterproof button: IP44
- power button: unpowered
- number of receivers in a package: 1 pc
- volume control: yes, 4 levels
- power supply of the main unit: 230 V AC



P5729B 1/-/-/14
34 02 121 000 P5729B



- reach of the button: 150 m
- number of melodies: 36
- pairing method: automatic pairing – self-learning
- special functions: highly visible optical signalisation
- optical signaling on the doorbell
- optical signaling on the button
- maximum ringing volume: 110 dB
- option to add another button: yes, max. 8
- number of buttons in a package: 1 pc
- extra (spare) button: P5732T
- waterproof button: IP44
- power button: 1× 3 V CR2032 (included)
- number of receivers in a package: 1 pc
- volume control: yes, 4 levels
- power supply of the main unit: 230 V AC



P5733W 1/-/-/14
34 02 122 000 P5733W



- reach of the button: 150 m
- number of melodies: 36
- pairing method: automatic pairing – self-learning
- special functions: highly visible optical signalisation
- optical signaling on the doorbell
- optical signaling on the button
- maximum ringing volume: 110 dB
- option to add another button: yes, max. 8
- number of buttons in a package: 1 pc
- extra (spare) button: P5732T
- waterproof button: IP44
- power button: 1× 3 V CR2032 (included)
- number of receivers in a package: 1 pc
- volume control: yes, 4 levels
- power supply of the main unit: 230 V AC



P5733S 1/-/-/14
34 02 123 000 P5733S



- reach of the button: 150 m
- number of melodies: 36
- pairing method: automatic pairing – self-learning
- special functions: highly visible optical signalisation
- optical signaling on the doorbell
- optical signaling on the button
- maximum ringing volume: 110 dB
- option to add another button: yes, max. 8
- number of buttons in a package: 1 pc
- extra (spare) button: P5732T
- waterproof button: IP44
- power button: 1× 3 V CR2032 (included)
- number of receivers in a package: 1 pc
- volume control: yes, 4 levels
- power supply of the main unit: 230 V AC



P5733G 1/-/-/14
34 02 124 000 P5733G



- reach of the button: 150 m
- number of melodies: 10
- pairing method: automatic pairing – self-learning
- optical signaling on the doorbell
- optical signaling on the button
- maximum ringing volume: 85 dB
- option to add another button: yes, max. 8
- number of buttons in a package: 1 pc
- extra (spare) button: P5734T
- waterproof button: IP56
- power button: 1× 3 V CR2032 (included)
- number of receivers in a package: 1 pc
- volume control: yes, 5 levels
- power supply of the main unit: 230 V AC



P5734 1/-/-/14
34 02 125 000 P5734



- reach of the button: 150 m
- number of melodies: 10
- pairing method: automatic pairing – self-learning
- optical signaling on the doorbell
- optical signaling on the button
- maximum ringing volume: 85 dB
- option to add another button: yes, max. 8
- number of buttons in a package: 1 pc
- extra (spare) button: P5734T
- waterproof button: IP56
- power button: 1× 3 V CR2032 (included)
- number of receivers in a package: 1 pc
- volume control: yes, 5 levels
- power supply of the main unit: 230 V AC



P5734B 1/-/-/14
34 02 126 000 P5734B



Spare push buttons

- spare or additional buttons for EMOS doorbells
- wireless, compatible with certain door chime type
- most commonly require 1 battery, water resistant (IP44)

- power source: unpowered
- pairing method: self-learning (automatic pairing)
- range in open space: up to 150 m
- IP rating: IP55
- designed for the type of bell: P5750, P5750.2T, P575



P5750T 1/-/-/50
34 02 118 001 P5750T



- power source: 1× 3 V CR2032 (included)
- pairing method: self-learning (automatic pairing)
- range in open space: up to 120 m
- IP rating: IP44
- designed for the type of bell: P5760, P5763, P5763R

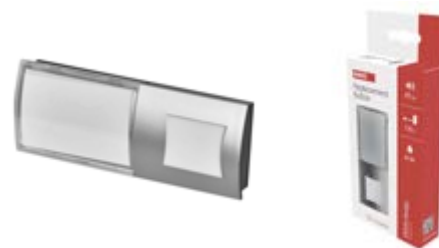

P5760T
34 02 060 002

1/-/5/40
P5760T

- power source: 1× 3 V CR2032 (included)
- pairing method: self-learning (automatic pairing)
- range in open space: up to 100 m
- IP rating: IP44
- designed for the type of bell: 98103, 98098, 98105,



P5723T
34 02 108 000

1/-/-/48
98YK

- power source: 1× 3 V CR2032 (included)
- pairing method: self-learning (automatic pairing)
- range in open space: up to 150 m
- IP rating: IP44
- designed for the type of bell: P5727



P5727T
34 02 112 000

1/-/-/50
P5727T

- power source: 1× 12 V A23 (included)
- pairing method: self-learning (automatic pairing)
- range in open space: up to 180 m
- IP rating: IP56
- designed for the type of bell: P5728, P5730



P5728T
34 02 113 000

1/-/-/50
P5728T

- power source: unpowered
- pairing method: self-learning (automatic pairing)
- range in open space: up to 180 m
- IP rating: IP44
- designed for the type of bell: P5729, P5729B, P5731



P5729T
34 02 114 000

1/-/-/50
P5729T

- power source: 1× 3 V CR2032 (included)
- pairing method: self-learning (automatic pairing)
- range in open space: up to 100 m
- IP rating: IP44
- designed for the type of bell: P5732, P5733W, P573



P5732T 1/-/-/50
34 02 117 001 P5732T

- power source: 1× 3 V CR2032 (included)
- pairing method: self-learning (automatic pairing)
- range in open space: up to 150 m
- IP rating: IP56
- designed for the type of bell: P5734, P5734B



P5734T 1/-/-/50
34 02 126 001 P5734T

Wired doorbells

- classic mechanical bells with one melody
- distance between bell and button exactly according to the user's needs
- constantly functional thanks to 230 V power supply

- reach of the button: wiring connection
- number of melodies: 1
- maximum ringing volume: 85 dB
- power button: wiring connection
- number of receivers in a package: 1 pc
- power supply of the main unit: 230 V AC



P57001 1/-/-/20
34 01 000 010 P57001

- reach of the button: wiring connection
- number of melodies: 1
- maximum ringing volume: 85 dB
- power button: wiring connection
- number of receivers in a package: 1 pc
- power supply of the main unit: 230 V AC



P57002 1/-/-/20
34 01 000 020 P57002

Sensors GoSmart



- Sensors to secure your home
- Motion detection and instant notification in the app
- Window and door security check
- Real-time identification of unusual situations
- Connect to your home network via ZigBee protocol
- Compatibility with EMOS GoSmart products and TUYA devices
- Voice control with Google Assistant and Amazon Alexa

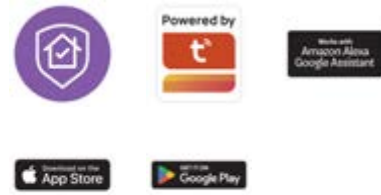

- product: motion sensor
- detection angle: 90°
- detection distance: 8 m
- IP rating: IP20
- sensor type: PIR
- power source: 1× CR123A (3 V)
- packaging: 1 pc, small box
- supported OS: Android, iOS
- compatibility: EMOS GoSmart, TUYA, LIDL, Smartlife
- protocol: Zigbee 3.0
- transmission frequency: 2.4 GHz (2 405–2 480 MHz)
- notifications to the mobile app
- application languages: EN, CZ, SK, PL, DE, HU, SI, FR,



8 592920 128749 | **H5020** | 1/-/-/40
30 69 052 010 | IP-2210Z

- product: door/window sensor
- IP rating: IP20
- sensor type: magnetic
- power source: 1× CR2032 (3 V)
- packaging: 1 pc, small box
- supported OS: Android, iOS
- compatibility: EMOS GoSmart, TUYA, LIDL, Smartlife
- protocol: Zigbee 3.0
- transmission frequency: 2.4 GHz (2 405–2 480 MHz)
- notifications to the mobile app
- application languages: EN, CZ, SK, PL, DE, HU, SI, FR,



8 592920 128732 | **H5021** | 1/-/-/100
30 69 052 020 | IP-2211Z

Multimeters, testers



Multimeters, measuring cables

- multimeters measure electrical quantities – voltage, etc.
- automatic or manual measurement range selection
- also measure temperature and allow diode or transistor tests
- clamp multimeter for higher values, w/o circuit interruption
- plus spare measuring leads with tips, for any multimeter

AC voltage: 600 mV – 750 V = AC current: 600 μ A–10 A = DC voltage: 600 mV – 1 000 V = DC current: 600 μ A–10 A = screen display: 5 3/4 digit = backlight display = range selection: both automatic and manual = electrical resistance: 600 Ohm – 60 MOhm = circuit continuity = diode test = transistor test = temperature measurement: -40 °C to +300 °C = max. value hold = Data hold mode = auto power off = included: battery, measurement tips, reduction for measuring transistors, temperature probe type K = power source: 1 \times 9 V (included) = dimensions: 35 \times 90 \times 190 mm



M0430

1/-/-8

22 02 019 000

MD-430

AC voltage: 2–300 V = AC current: 200 μ A – 10 A / with pliers up to 1 000 A (not included) = DC voltage: 200 mV – 300 V = DC current: 200 μ A – 10 A / with pliers up to 1 000 A (not included) = screen display: 3.5 digit = backlight display = range selection: automatic = electrical resistance: 200 Ohm – 20 MOhm = circuit continuity = diode test = transistor test = temperature measurement: -20 °C to +1 000 °C = max. value hold = Data hold mode = auto power off = included: battery, test leads, reduction for measuring transistors, temp. probe type K, lock the battery cover = power source: 3 \times 1.5 V AAA (included) = dimensions: 35 \times 75 \times 158 mm



M0420

1/-/10/20

22 02 008 000

MD-420

AC voltage: 200 mV – 300 V = AC current: 20 mA – 10 A = DC voltage: 200 mV – 300 V = DC current: 20 mA – 10 A = screen display: 3.5 digit = backlight display = range selection: manual = non-contact AC voltage detection = electrical resistance: 200 Ohm – 20 MOhm = circuit continuity = diode test = battery test = temperature measurement: 0 °C to +1 000 °C = Data hold mode = included: battery, manual, measurement tips = power source: 1 \times 9 V (included) = dimensions: 168 \times 83 \times 35 mm



M3691

1/-/-20

22 02 016 000

EM3691

AC voltage: 200–300 V = DC voltage: 200 mV – 300 V = DC current: 20 mA – 10 A = screen display: 3.5 digit = backlight display = range selection: manual = electrical resistance: 200 Ohm – 2 MOhm = circuit continuity = diode test = battery test = Data hold mode = included: battery, manual, measurement tips = power source: 1× 9 V (included) = dimensions: 150 × 75 × 35 mm



M3620 1/-/-/20
22 02 017 000 MD-310

AC voltage: 200–600 V = AC current: 200 mA – 10 A = DC voltage: 2–600 V = DC current: 200 mA – 10 A = screen display: 3.5 digit = backlight display = range selection: manual = electrical resistance: 200 Ohm – 2 MOhm = circuit continuity = diode test = battery test: 1.5 V/9 V = temperature measurement: -40 °C to +300 °C = Data hold mode = auto power off = included: battery, manual, measurement tips, temperature probe = power source: 3× 1.5 V AAA (included) = dimensions: 35 × 75 × 155 mm



M0230 1/-/-/20
22 02 020 000 MD-230

AC voltage: 2–600 V = AC current: 2 mA – 10 A = DC voltage: 200 mV – 600 V = DC current: 2 mA – 10 A = screen display: 3.5 digit = range selection: manual = electrical resistance: 200 Ohm – 20 MOhm = circuit continuity = diode test = transistor test = included: battery, manual, measurement tips = power source: 1× 9 V (included) = dimensions: 32 × 85 × 165 mm



M2092 1/-/5/15
22 02 003 000 MD-220

AC voltage: 200–300 V = DC voltage: 200 mV – 300 V = DC current: 20 µA – 10 A = screen display: 3.5 digit = range selection: manual = electrical resistance: 200 Ohm – 2 MOhm = circuit continuity = diode test = included: battery, manual, measurement tips, protective case = power source: 1× 9 V (included) = dimensions: 27 × 70 × 135 mm



M0391 1/-/10/20
22 02 007 000 MD-210

AC voltage: 200–300 V = DC voltage: 200 mV – 300 V = DC current: 2 000 µA – 200 mA = screen display: 3.5 digit = range selection: manual = electrical resistance: 200 Ohm – 2 MOhm = diode test = battery test: 1.5 V/9 V = included: battery, manual, measurement tips = power source: 1× 12 V (included) = dimensions: 30 × 57 × 95 mm



M0320 1/-/6/18
22 02 014 000 MD-110

AC voltage: 4-600 V = AC current: 400 A = DC voltage: 400 mV - 600 V = DC current: 400 A = clamp multimeter = screen display: 3 3/4 digit = range selection: automatic = electrical resistance: 400 Ohm - 40 MOhm = circuit continuity = diode test = temperature measurement: -20 °C to +1 000 °C = Data hold mode = auto power off = included: battery, manual, measurement tips = power source: 2x 1.5 V AAA (included) = dimensions: 38 x 71 x 194 mm



M0400 1/-/-/20
22 02 013 000 MD-410C

AC voltage: 2-600 V = AC current: 2-600 A = DC voltage: 200 mV - 600 V = clamp multimeter = screen display: 3.5 digit = range selection: automatic = electrical resistance: 200 Ohm - 20 MOhm = circuit continuity = diode test = Data hold mode = auto power off = included: battery, manual, measurement tips = power source: 2x 3 V CR2032 (included) = dimensions: 36 x 76 x 190 mm



M0305 1/-/12/24
22 02 015 000 MD-310C

cable length: 95 cm = maximum load: 1 A, 30 V AC, 60 V DC = possibility to tips exchange = colour: red, black = packaging: 1 pc, blister

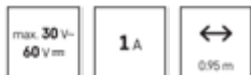

S4001N 1/5/-/50
23 04 000 101 S4001N

cable length: 95 cm = maximum load: 10 A, 1 kV, CAT III = colour: red, black = packaging: packet

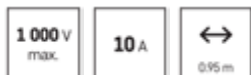

S4003 1/-/-/200
23 04 000 300 BB58

AC voltage: 2-600 V = AC current: 200 µA - 200 mA = DC voltage: 200 mV - 600 V = DC current: 200 µA - 200 mA = screen display: 3 1/2 digit = backlight display = range selection: automatic = electrical resistance: 200 Ohm - 20 MOhm = circuit continuity = diode test = max. value hold = Data hold mode = auto power off = included: battery, manual, measurement tips = power source: 2x 1.5 V AAA (included) = dimensions: 44 x 38 x 230 mm



M3216 1/-/-/6
22 02 021 000 MD-300

Testers

- voltage tester for measuring voltage value
- also identifies phases, sequence and polarity
- detects DC and AC voltage, contact or non-contact
- results indicated optically and acoustically

DC voltage: 6–690 V = AC voltage: 6–690 V = AC/DC voltage: 6 V, 12 V, 24 V, 50 V, 120 V, 230 V, 400 V, 690 V = polarity indication = phase indication = signalization: optical + acoustic = power source: 2× 1.5 V AAA (included) = frequency range: 45–65 Hz = measuring of connections of circuits = packaging: 1 pc, blister



M0071 1/-/-/10
22 01 013 000 VT-710

DC voltage: 12–690 V = AC voltage: 12–690 V = AC/DC voltage: 12 V, 24 V, 50 V, 120 V, 230 V, 400 V, 690 V = polarity indication = phase indication = signalization: optical + acoustic = power source: 9 V (included) = frequency range: 0–60 Hz = measuring of connections of circuits = packaging: 1 pc, blister



M0012A 1/5/-/15
22 01 014 000 VT-320

DC voltage: 110–400 V = AC voltage: 110–400 V = AC/DC voltage: 110 V, 230 V, 400 V = polarity indication = phase indication = signalization: optical = power source: from power source = frequency range: 0–60 Hz = packaging: 1 pc, blister



M0014A 1/5/-/15
22 01 012 000 VT-310

detection: AC wiring = signalization: optical + acoustic = AC voltage: 70–1 000 V = dimensions: 153 × 22 mm = power source: 2× 1.5 V AAA (included) = packaging: 1 pc, blister



M0007A 1/-/30/60
22 05 000 010 VT-150

DC voltage: 0 to 250 V contactless = AC voltage: 70 to 250 V contactless = AC/DC voltage: 0-250 V, 70-250 V = polarity indication = non-contact measuring: polarity of sources and short-circuit, microwave ovens monitors emission = signalization: optical = power source: 2x 1.5 V LR41 (included) = frequency range: 0-60 Hz = packaging: 1 pc, blister

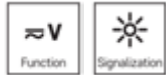

M0018
22 01 001 000

1/5/-/45
VT-110

DC voltage: 0 to 250 V contactless = AC voltage: 70 to 250 V contactless = AC/DC voltage: 0-250 V, 70-250 V = polarity indication = non-contact measuring: polarity of sources and short-circuit, microwave ovens monitors emission = two settings of sensitivity = signalization: optical + acoustic = power source: 2x 1.5 V LR44 (included) = frequency range: 0-60 Hz = packaging: 1 pc, blister



M0048
22 01 002 000

1/5/-/50
VT-120

DC voltage: 6-400 V = AC voltage: 6-400 V = AC/DC voltage: 6 V, 12 V, 24 V, 50 V, 120 V, 230 V, 400 V = polarity indication = signalization: optical = power source: from power source = frequency range: 0-60 Hz = packaging: 1 pc, blister



M0003B
22 01 015 000

1/-/5/40
VT-211

designed for battery type: AAA, AA, C, D, 9 V and for button cells 1.5 V, 3 V = type: UNI D3 = value of load resistance for the AA, AAA, C, D, 9 V: universal = the value of load resistance for button batteries: universal = dimensions: 110 x 60 x 25 mm



N0322
22 03 003 000

1/-/5/50
UNI D3

Measuring instruments

- multidetector maps electrical wiring – no more drilled wires
- laser range finder calculates distance, area and room volume
- non-contact voltage detector for AC voltage up to 1 000 V

detection: wood, metal, AC wiring = signalization: optical + acustic = dimensions: 28 × 72 × 155 mm = power source: 1 × 9 V (included) = packaging: 1 pc, blister

**M0501**

1/-/5/30

22 06 000 010

M0501

measuring distance: 0.05–40 m = measuring functions: length, surface, volume, continual measurement, Pythagoras = measuring units: m, ft, in, m², ft², m³, ft³ = power source: 2 × 1.5 V AAA (not included) = packaging: 1 pc, small box

**M0502**

1/-/-/50

22 06 000 020

M0502

measuring functions: temperature = measuring units: °C/°F = power source: 1 × 9 V = packaging: 1 pc, blister

**M0503**

1/-/-/18

22 06 000 030

M0503

Thermostats, CO and smoke alarms



Thermostats

Thermostats EMOS

- indoor thermostats regulate heating systems & cooling units
- manual and digital, with programmable heating cycle
- wireless, wired and clamp-on (monitor service water temp.)
- often with backlit display and always with freeze protection
- bestseller: wireless digital thermostats (simple to install)

thermostat type: wireless with OpenTherm communication = type of control: programmable electronic indoor thermostat = backlight display = control mode: heating and cooling system = number of programs: 6 + 3 customizable for users = temperature adjustment type: comfort and economy temperature = temperature measurement: 0 °C to 40 °C, resolution 0.2 °C = temperature adjustment: from 7 °C up to 30 °C, after 0.2 °C = anti-frost protection = ON/OFF function = switching: 230 V AC or potential-free = switching load: 16 A resistive, 5 A inductive = power of transmitter: 2x 1.5 V AA (included) = power of receiver: 230 V AC = receiver's dimension: 37 x 115 x 91 mm = transmitter's dimension: 23 x 97 x 122 mm



P56110T

1/-/-/10

21 01 309 000

P56110T



thermostat type: wireless = type of control: programmable electronic room thermostat, option to control via mobile phone (iOS, Android) = backlight display = control mode: heating system = number of programs: customisable = temperature adjustment type: 6 temperature changes per day = temperature measurement: 0 °C to 40 °C, resolution 0.1 °C = temperature adjustment: 5 °C to 35 °C, resolution 0.5 °C = anti-frost protection = ON/OFF function = holiday mode = switching: 230 V AC or potential-free = switching load: 16 A resistive, 4 A inductive = power of transmitter: 5 V USB adapter (included) = power of receiver: 230 V AC = receiver's dimension: 37 x 86 x 86 mm = transmitter's dimension: 15 x 96 x 96 mm = part of the package: wireless thermostat, wireless receiver, USB car charger 5 V/1.5 A, micro USB cable 1.5 m



P5623

1/-/-/8

21 01 306 000

P5623





www.emos.eu

Order Code
Item Number

Packaging
Type

thermostat type: wireless with OpenTherm communication = type of control: programmable electronic indoor thermostat = backlight display = control mode: heating and cooling system = number of programs: 1 customisable programme or customisable temperature (6× per day) = temperature adjustment type: 6 temperature changes per day = temperature measurement: 0 °C to 40 °C, resolution 0.1 °C = temperature adjustment: from 5 °C up to 35 °C, after 0.5 °C = anti-frost protection = ON/OFF function = holiday mode = switching: 230 V AC or potential-free = switching load: 10 A resistive, 4 A inductive = power of transmitter: 2× 1.5 V AA (included) = power of receiver: 230 V AC = receiver's dimension: 26 × 86 × 86 mm = transmitter's dimension: 26 × 126 × 84 mm



P56160T 1/-/-12
21 01 307 000 P56160T

thermostat type: wireless = type of control: manual electronic indoor thermostat = backlight display = control mode: heating and cooling system = number of programs: user adjustable temperature = temperature adjustment type: manually = temperature measurement: 0 °C to 40 °C, resolution 0.1 °C = temperature adjustment: from 5 °C up to 35 °C, after 0.5 °C = anti-frost protection = ON/OFF function = switching: 230 V AC or potential-free = switching load: 16 A resistive, 4 A inductive = power of transmitter: 2× 1.5 V AAA (included) = power of receiver: 230 V AC = receiver's dimension: 26 × 86 × 86 mm = transmitter's dimension: 28 × 120 × 77 mm



P5614 1/-/-12
21 01 106 010 P5614

thermostat type: wired with OpenTherm communication = type of control: programmable electronic indoor thermostat = backlight display = control mode: heating and cooling system = number of programs: 1 customisable programme or customisable temperature (6× per day) = temperature adjustment type: 6 temperature changes per day = temperature measurement: 0 °C to 40 °C, resolution 0.1 °C = temperature adjustment: from 5 °C up to 35 °C, after 0.5 °C = anti-frost protection = ON/OFF function = holiday mode = switching: 230 V AC or potential-free = switching load: 6 A resistive, 2 A inductive = power source: 2× 1.5 V AA (included) = dimensions: 26 × 126 × 84 mm



P56060T 1/-/-40
21 01 208 000 P56060T

thermostat type: wire = type of control: programmable electronic indoor thermostat = backlight display = control mode: heating and cooling system = number of programs: 1 customisable programme or customisable temperature (6× per day) = temperature adjustment type: 6 temperature changes per day = temperature measurement: 0 °C to 40 °C, resolution 0.1 °C = temperature adjustment: from 5 °C up to 35 °C, after 0.5 °C = anti-frost protection = switching: 230 V AC or potential-free = switching load: 8 A resistively, 2 A inductively = power source: 2× 1.5 V AAA (included) = dimensions: 26 × 120 × 78 mm



P5607 1/-/-20
21 01 209 000 P5607

thermostat type: wire = type of control: manual indoor thermostat = backlight display = control mode: heating and cooling system = number of programs: user adjustable temperature = temperature adjustment type: manually = temperature measurement: 0 °C to 40 °C, resolution 0.1 °C = temperature adjustment: from 5 °C up to 35 °C, after 0.5 °C = anti-frost protection = switching: 230 V AC or potential-free = switching load: 8 A resistively, 2 A inductively = power source: 2× 1.5 V AAA (included) = dimensions: 30 × 120 × 77 mm



P5604 1/-/-40
21 01 106 000 P5604

thermostat type: wire = type of control: manual indoor thermostat = control mode: heating and cooling system = number of programs: user adjustable temperature = temperature adjustment type: manually = temperature measurement: 0 °C to 40 °C, resolution 1 °C = temperature adjustment: from 5 °C up to 30 °C, after 1 °C = anti-frost protection = switching: 230 V AC or potential-free = switching load: 6 A resistive, 2 A inductive = power source: 2× 1.5 V AA (included) = dimensions: 40 × 93 × 86 mm



P5603R
21 01 106 001

1/-/-/36
P5603R

thermostat type: wired for underfloor heating, concealed = type of control: programmable electronic indoor thermostat = backlight display = control mode: heating system = number of programs: 1 customisable programme or customisable temperature (6× per day) = temperature adjustment type: 6 temperature changes per day = temperature measurement: 0 °C to 99 °C, resolution 0.1 °C = temperature adjustment: from 5 °C up to 95 °C, after 0.5 °C = anti-frost protection = ON/OFF function = switching: voltage 230 V AC, 50 Hz = switching load: 16 A resistive = power source: 230 V AC = dimensions: 43 × 86 × 90 mm = part of the package: thermostat, floor sensor 3 m



P5601UF
21 01 210 000

1/-/-/14
P5601UF

thermostat type: wire, flow thermostat = type of control: manual thermostat = control mode: heating and cooling system = temperature measurement: 0 °C to 90 °C = temperature adjustment: 0 °C to 90 °C, resolution 5 °C = switching: voltage 230 V AC, 50 Hz = switching load: 16 A resistive, 4 A inductive = power source: 230 V, 400 V AC = dimensions: 38 × 54 × 105 mm



P5681
21 01 103 000

1/-/5/20
T80

thermostat type: wire, capillary sensor thermostat = type of control: manual thermostat = control mode: heating and cooling system = temperature measurement: 0 °C to 90 °C = temperature adjustment: 0 °C to 90 °C, resolution 5 °C = switching: voltage 230 V AC, 50 Hz = switching load: 16 A resistive, 4 A inductive = capillary sensor length: 1 m, Ø 7 mm = power source: 230 V, 400 V AC = dimensions: 38 × 54 × 105 mm



P5682
21 01 104 000

1/-/5/20
T80F

thermostat type: wire, flow thermostat = type of control: manual thermostat = backlight display = control mode: heating and cooling system = temperature adjustment type: manually = temperature measurement: 5 °C to 80 °C, resolution 0.1 °C = temperature adjustment: from 5 °C up to 80 °C, after 0.1 °C = ON/OFF function = switching: voltage 230 V AC, 50 Hz = switching load: 5 A resistively, 1.5 A inductively = power source: 230 V AC = dimensions: 41 × 50 × 138 mm



P5683
21 01 107 000

1/-/5/30
P5683



www.emos.eu

Order Code
Item Number

Packaging
Type

thermostat type: wire, capillary sensor thermostat = type of control: manual thermostat = backlight display = control mode: heating and cooling system = temperature adjustment type: manually = temperature measurement: 5 °C to 90 °C, resolution 0.1 °C = temperature adjustment: from 5 °C up to 90 °C, after 0.1 °C = ON/OFF function = switching: voltage 230 V AC, 50 Hz = switching load: 5 A resistively, 1.5 A inductively = capillary sensor length: 0.9 m, Ø 6 mm = power source: 230 V AC = dimensions: 36 × 45 × 138 mm



P5684
21 01 108 000

1/-/5/30
P5684

thermostat type: wire, flow thermostat = type of control: manual thermostat = control mode: heating and cooling system = temperature measurement: 0 °C to 90 °C = temperature adjustment: 0 °C to 90 °C, resolution 5 °C = switching: voltage 230 V AC, 50 Hz = switching load: 16 A resistive, 4 A inductive = power source: 230 V, 400 V AC = dimensions: 57 × 38 × 108 mm, thermowell: 110 mm, Ø 8 mm, 1/2" thread



P5685
21 01 109 000

1/-/5/15
P5685

thermostat type: wire, flow thermostat = type of control: manual thermostat = backlight display = control mode: heating and cooling system = temperature adjustment type: manually = temperature measurement: 5 °C to 80 °C, resolution 0.1 °C = temperature adjustment: from 5 °C up to 80 °C, after 0.1 °C = ON/OFF function = switching: voltage 230 V AC, 50 Hz = switching load: 5 A resistively, 1.5 A inductively = power source: 230 V AC = dimensions: 45 × 36 × 140 mm, thermowell: 58 mm, Ø 8 mm, 1/2" thread



P5686
21 01 110 000

1/-/5/20
P5686

thermostat type: wireless with OpenTherm communication = switching: 230 V AC or potential-free = switching load: 16 A resistive, 5 A inductive = power of receiver: 230 V AC = receiver's dimension: 37 × 115 × 91 mm



P56110TR
21 01 308 000

1/-/-/36
P56110TR

thermostat type: socket = type of control: programmable electronic indoor thermostat = backlight display = control mode: heating and cooling system = number of programs for thermostat: customisable temperature (6× per day) = temperature adjustment type: 6 temperature changes per day = temperature measurement: 0 °C to 45 °C, resolution 0.1 °C = temperature adjustment: 5 °C to 40 °C, resolution 0.5 °C = adjustable variance of temperature: from 0.2 °C up to 2 °C, after 0.1 °C = number of programs for timer: 24 = number of switching per day for timer: 24 = function to change summer/winter time = countdown function = dimensions: 82 × 62 × 146 mm



P5660FR
21 06 000 100

1/-/-/16
P5660FR

Thermostats GoSmart



- Reduce heating/cooling costs for buildings
- Individual temperature settings for different rooms
- Set temperature scenarios for specific day and time
- Control all settings from anywhere using the app
- Heating or air conditioning control based on GPS location
- Connection via WIFI or Zigbee protocols
- Compatibility with EMOS GoSmart products and TUYA devices
- Voice control with Google Assistant and Amazon Alexa

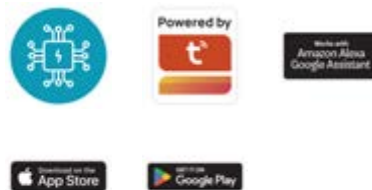

thermostat type: wire = type of control: programmable electronic room thermostat, option to control via mobile phone (iOS, Android) = backlight display = control mode: heating and cooling system = number of programs: customisable temperature (6× per day) = temperature adjustment type: 6 temperature changes per day = temperature measurement: 0 °C to 40 °C, resolution 0.1 °C = temperature adjustment: from 5 °C up to 35 °C, after 0.5 °C = anti-frost protection = ON/OFF function = holiday mode = switching: voltage 230 V AC, 50 Hz = switching load: 6 A resistive, 2 A inductive = power source: 230 V AC = dimensions: 138 × 88 × 33 mm



P56201 1/-/-12
21 01 900 000 P56201

thermostat type: wireless = type of control: programmable electronic room thermostat, option to control via mobile phone (iOS, Android) = backlight display = control mode: heating and cooling system = number of programs: customisable temperature (6× per day) = temperature adjustment type: 6 temperature changes per day = temperature measurement: 0 °C to 40 °C, resolution 0.1 °C = temperature adjustment: from 5 °C up to 35 °C, after 0.5 °C = anti-frost protection = ON/OFF function = holiday mode = switching: 230 V AC or potential-free = switching load: 16 A resistive, 4 A inductive = power of transmitter: 5 V USB adapter (included) = power of receiver: 230 V AC = receiver's dimension: 37 × 86 × 86 mm = transmitter's dimension: 40 × 138 × 96 mm



P56211 1/-/-9
21 01 900 001 P56211

thermostat type: wired for underfloor heating, concealed = type of control: programmable electronic room thermostat, option to control via mobile phone (iOS, Android) = backlight display = control mode: heating system = number of programs: customisable temperature (6× per day) = temperature adjustment type: 6 temperature changes per day = temperature measurement: 0 °C to 95 °C, resolution 0.5 °C = temperature adjustment: from 1 °C up to 70 °C, after 0.5 °C = anti-frost protection = ON/OFF function = holiday mode = switching: voltage 230 V AC, 50 Hz = switching load: 16 A resistive = power source: 230 V AC = dimensions: 86 × 86 × 43 mm = part of the package: thermostat, floor sensor 3 m, Ø 8 mm



P56201UF 1/-/-36
21 01 900 002 P56201UF

thermo shut-off valve: SMART, programmable = number of programs: 1 customisable programme or customisable temperature (6× per day) = temperature adjustment type: 6 temperature changes per day = temperature measurement: 0 °C to 70 °C, resolution 0.5 °C = temperature adjustment: 1 °C to 70 °C, resolution 0.5 °C = anti-frost protection = holiday mode = open window function = child lock = matrix: M30 × 1.5 mm = enclosed adaptors: Danfoss RA, RAV, RAVL = power source: 2× 1.5 V AA (included) = dimensions: 55 × 94 × 55 mm = packaging: 1 pc, small box



P5630S 1/-/-24
21 01 900 003 P5630S

CO and smoke alarms

- life investment for families w/ gas boiler/cooker/fireplace
- CO detector identifies carbon monoxide (invisible, odorless)
- smoke detector alerts to potential fires in the household
- EMOS detectors with 7 or 10 year service life

detection type: detector CO = type of installation: possible to mount on the wall or freestanding = type of signaling: optical and audible = operating temperature: -10 °C to 40 °C = operating humidity: 30-95 % = lifetime: 10 years = IP rating: IP30 = power source: 2x 1.5 V AA, included = packaging: 1 pc, small box



P56402 1/-/5/15
 21 01 501 020 GS827

detection type: smoke detector = type of installation: possible to mount on the wall or freestanding = type of signaling: optical and audible = possibility to connect to other detectors: yes, wireless = module range: up to 20 m = transmission frequency: 433 MHz = operating temperature: 10 °C to 45 °C = operating humidity: 30-95 % = lifetime: 10 years = IP rating: IP20 = power source: 2x 1.5 V AA, included = packaging: 1 pc, small box



P56500 1/-/5/15
 21 01 505 000 GS558

detection type: smoke detector = type of installation: possible to mount on the wall or freestanding = type of signaling: optical and audible = operating temperature: 0 °C to 40 °C = operating humidity: 5-95 % = lifetime: 10 years = power source: 1x 9 V, included = packaging: 1 pc, small box



P56501 1/-/5/40
 21 04 101 000 GS536

detection type: gas detector = type of installation: possible to mount on the wall or freestanding = type of signaling: optical and audible = operating temperature: -10 °C to 40 °C = operating humidity: 0-95 % = lifetime: 5 years = IP rating: IPX20 = power source: 230 V AC = packaging: 1 pc, small box



P56450 1/-/18
 21 01 505 003 GS869

detection type: smoke detector = type of installation: wall mounting = type of signaling: optical and audible = possibility to connect to other detectors: yes, by wire (max. 40 pcs) = operating temperature: 0 °C to 40 °C = operating humidity: 0-93 % = lifetime: 10 years = power source: 230 V AC, back-up battery: 1× 9 V, included = packaging: 1 pc, small box



P56502 1/-/-/12
21 01 505 006 TSS890B-HI

detection type: heat detector = type of installation: possible to mount on the wall or freestanding = type of signaling: optical and audible = operating temperature: 0 °C to 65 °C = operating humidity: 0-93 % = lifetime: 10 years = power source: 1× 9 V, included = packaging: 1 pc, small box



P56300 1/-/-/30
21 04 102 000 THS916A

Valve closer GoSmart



- Manual and automatic control
- Timer function for setting a schedule
- High power and torque
- Immediate response to crash detection
- Connection to home network via ZIGBEE protocol
- Compatibility with EMOS GoSmart products and TUYA devices
- Voice control with Google Assistant and Amazon Alexa

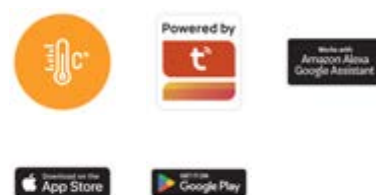

- product: valve controller
- pipe diameter: 1/2", 3/4", 1" a 1 1/4"
- torque: max. 5.88 Nm
- operating temperature: -10 °C to 55 °C
- operating humidity: <95 %
- IP rating: IP20
- power source: DC 12 V/1 000 mA, 1.4 m (included)
- supported OS: Android, iOS
- compatibility: EMOS GoSmart, TUYA, LIDL, Smartlife
- protocol: Zigbee 3.0
- transmission frequency: 2.4 GHz Wi-Fi
- notifications to the mobile app
- control by voice assistants
- application languages: EN, CZ, SK, PL, DE, HU, SI, FR,



P5640S 1/-/-/12
21 05 564 000 P5640S

Detectors GoSmart



- Detectors to secure your home
- Immediate notification of an unusual situation via the app
- Optical and audible signalling
- Sensors that detect water/gas leaks, fire, etc.
- Connect to your home network via Wi-Fi/ZigBee protocol
- Compatibility with EMOS GoSmart products and TUYA devices
- Voice control with Google Assistant and Amazon Alexa

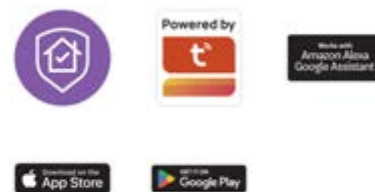

- detection type: smoke detector
- type of installation: possible to mount on the wall o
- type of signaling: optical and audible
- transmission frequency: 2.4 GHz Wi-Fi
- operating temperature: 0 °C to 40 °C
- operating humidity: 0-93 %
- lifetime: 10 years
- IP rating: IP20
- power source: 2× 1.5 V AA, included
- packaging: 1 pc, small box
- supported OS: Android, iOS
- compatibility: EMOS GoSmart, TUYA, LIDL, Smartlife,
- protocol: Wi-Fi
- notifications to the mobile app
- application languages: EN, CZ, SK, PL, DE, HU, SI, FR,



8 592920 122143
P56500S 1/-/-16
 21 04 103 000 P56500S



- detection type: water leak detector
- type of installation: free-standing
- type of signaling: optical and audible
- memory of alarms
- transmission frequency: Zigbee 3.0
- operating temperature: 5 °C to 38 °C
- operating humidity: ≤80 % without condensation
- lifetime: 10 years
- IP rating: IP65
- power source: 1× 3 V CR2, included
- packaging: 1 pc, small box
- supported OS: Android, iOS
- compatibility: EMOS GoSmart, TUYA, LIDL, Smartlife,
- protocol: Zigbee 3.0
- notifications to the mobile app
- application languages: EN, CZ, SK, PL, DE, HU, SI, FR,



8 592920 122136
P56000S 1/-/-48
 21 04 104 000 P56000S



- detection type: detector CO
- type of installation: possible to mount on the wall o
- type of signaling: optical and audible
- memory of alarms
- transmission frequency: 2.4 GHz Wi-Fi
- operating temperature: -10 °C to 40 °C
- operating humidity: 15-93 %
- lifetime: 10 years
- IP rating: IP30
- power source: 2× 1.5 V AA, included
- packaging: 1 pc, small box
- supported OS: Android, iOS
- compatibility: EMOS GoSmart, TUYA, LIDL, Smartlife,
- protocol: Wi-Fi
- notifications to the mobile app
- application languages: EN, CZ, SK, PL, DE, HU, SI, FR,



8 592920 130780
P56400S 1/-/-20
 21 04 105 000 TCS0101W



Installation material, tapes



Installation material



Sockets, switches

EMOS

IP20



- installation: into a junction box
- in white colour
- frame and button material: high-quality polycarbonate (PC)

A6100.0 1/-/10/60
19 06 200 100 W13-C120Y



product: alternating switch no. 6 = design: IP20 = type: 250 V~ = type of mounting: into a box = version: 1 button stairway = IP rating: IP20 = colour: white (gloss) = packaging: 1 pc, hanging

A6100.2 1/-/10/60
19 06 200 102 W13-C210/1Y



product: cross switch no. 7 = type: 250 V~/10 AX = type of mounting: into a box = version: 1 button = IP rating: IP20 = colour: white (gloss) = packaging: 1 pc, hanging

A6100.4 1/-/10/60
19 06 200 104 W13-C130Y

product: switch controller (1/0) = type: 250 V~/10 A = type of mounting: into a box = version: 1 button = IP rating: IP20 = colour: white (gloss) = packaging: 1 pc, hanging

A6100.1 1/-/10/60
19 06 200 101 W13-C210Y

product: parallel switch nr. 5 = type: 250 V~/10 AX = type of mounting: into a box = version: 2 buttons = IP rating: IP20 = colour: white (gloss) = packaging: 1 pc, hanging





www.emos.eu

Order Code
Item Number



Packaging
Type

A6100.3 1/-/10/60
19 06 200 103 W13-C230Y





product: double two-way switch 6+6 (5B) = type: 250 V~/10 AX = type of mounting: into a box = version: 2 buttons = IP rating: IP20 = colour: white (gloss) = packaging: 1 pc, hanging

A6003.0 1/-/10/40
19 06 300 103 W13-C192





product: switching device for adjustable LED lamps for turn-controls and button switching = design: 7-110 W/VA vakuové a halogenové žárovky na 230 V~, stmívatelné kompaktní zářivky. 3-60 W/VA pro stmívatelné LED = type: 230 V~, 50 Hz = version: turn-controls and button switching = colour: white (gloss) = packaging: 1 pc, hanging

A6000.5 1/-/10/40
19 06 010 512 W13-C311FUSBAC



product: single socket with protective contacts and USB output 3 A max. = design: SCHUKO = type: 250 V~/16 A max. = type of mounting: into a box (recommended depth min. 60 mm) = version: single = IP rating: IP20 = colour: white (gloss) = packaging: 1 pc, PE packet

A6000.1 1/-/10/40
19 06 010 501 W13-311FUSB2A



product: single socket with protective side contacts and USB output 2.1 A max. = design: SCHUKO = type: 250 V~/16 A max. = type of mounting: into a box (recommended depth min. 40 mm) = version: single = IP rating: IP20 = colour: white (gloss) = packaging: 1 pc, PE packet

A6004.2 1/-/5/30
19 06 300 100 W13-C004



product: quadruple frame = type: for horizontal and vertical installation = type of mounting: into a box = version: quadruple = colour: white (gloss) = packaging: 1 pc, hanging

A6004.0 1/-/10/60
19 06 300 102 W13-C002



product: double frame = type: for horizontal and vertical installation = type of mounting: into a box = version: double = colour: white (gloss) = packaging: 1 pc, hanging

A6004.1 1/-/10/60
19 06 300 101 W13-C003



product: triple frame = type: for horizontal and vertical installation = type of mounting: into a box = version: triple = colour: white (gloss) = packaging: 1 pc, hanging

A6004.4 1/-/10/240
19 06 300 105 W13-CTF/2



product: data socket cover 2xRJ45 = type of mounting: into a box = version: double = colour: white (gloss) = packaging: 1 pc, hanging

A6004.3 1/-/10/240
19 06 300 104 W13-CTRSO

product: socket cover TV+R+SAT = type of mounting: into a box = version: single = colour: white (gloss) = packaging: 1 pc, hanging

A6002.0 1/-/10/60
19 06 010 504 W13-C311

product: single socket with protective side contact = design: SCHUKO = type: 250 V~/16 A max. = type of mounting: into a box = version: single = IP rating: IP20 = colour: white (gloss) = packaging: 1 pc, hanging



www.emos.eu

Order Code
Item Number

Packaging
Type



A6100.5 1/-/10/60
19 06 200 105 W13-C120Y







product: alternating switch no. 6 = type: 250 V~/10 AX = type of mounting: into a box = version: 1 button stairway = IP rating: IP20 = colour: anthracite = packaging: 1 pc, hanging

A6100.7 1/-/10/60
19 06 200 107 W13-C210/1Y



product: cross switch no. 7 = type: 250 V~/10 AX = type of mounting: into a box = version: 1 button = IP rating: IP20 = colour: anthracite = packaging: 1 pc, hanging

A6100.9 1/-/10/60
19 06 200 109 W13-C130Y

product: switch controller (1/0) = type: 250 V~/10 A = type of mounting: into a box = version: 1 button = IP rating: IP20 = colour: anthracite = packaging: 1 pc, hanging

A6100.6 1/-/10/60
19 06 200 106 W13-C210Y

product: parallel switch nr. 5 = type: 250 V~/10 AX = type of mounting: into a box = version: 2 buttons = IP rating: IP20 = colour: anthracite = packaging: 1 pc, hanging

A6100.8 1/-/10/60
19 06 200 108 W13-C230Y





product: double two-way switch 6+6 (5B) = type: 250 V~/10 AX = type of mounting: into a box = version: 2 buttons = IP rating: IP20 = colour: anthracite = packaging: 1 pc, hanging

A6003.1 1/-/10/40
19 06 300 109 W13-C192





product: switching device for adjustable LED lamps for turn-controls and button switching = design: 7-110 W/VA vakuové a halogenové žárovky na 230 V~, stmívatelné kompaktní zářivky. 3-60 W/VA pro stmívatelné LED = type: 230 V~, 50 Hz = version: turn-controls and button switching = colour: anthracite = packaging: 1 pc, hanging

A6000.3 1/-/10/40
19 06 010 507 W13-311FUSB2A





product: single socket with protective side contact and USB output 2.1 A max. = design: SCHUKO = type: 250 V~/16 A max. = type of mounting: into a box (recommended depth min. 40 mm) = version: single = IP rating: IP20 = colour: anthracite = packaging: 1 pc, PE packet



A6002.2 1/-/10/60
19 06 010 510 W13-C311







product: single socket with protective pin and child safety cover = design: SCHUKO = type: 250 V~/16 A max. = type of mounting: into a box = version: single = IP rating: IP20 = colour: anthracite = packaging: 1 pc, hanging

A6004.5 1/-/10/60
19 06 300 108 W13-C002

product: double frame = type: for horizontal and vertical installation = type of mounting: into a box = version: double = colour: anthracite = packaging: 1 pc, hanging

A6004.6 1/-/10/60
19 06 300 107 W13-C003

product: triple frame = type: for horizontal and vertical installation = type of mounting: into a box = version: triple = colour: anthracite = packaging: 1 pc, hanging



www.emos.eu

Order Code
Item Number

Packaging
Type

A6004.7

1/-/5/30

19 06 300 106

W13-C004



product: quadruple frame = type: for horizontal and vertical installation = type of mounting: into a box = version: quadruple = colour: anthracite = packaging: 1 pc, hanging

A6004.8

1/-/10/240

19 06 300 110

W13-CTRSO



product: socket cover TV+R+SAT = type of mounting: into a box = version: single = colour: anthracite = packaging: 1 pc, hanging

A6004.9

1/-/10/240

19 06 300 111

W13-CTF/2RJ450



product: data socket cover 2xRJ45 = type of mounting: into a box = version: double = colour: anthracite = packaging: 1 pc, hanging

IP54/IP44

- installation: onto a wall
- enclosure: IP54, IP44
- double socket is internally interconnected

A1398

1/5/-/60

31 04 139 800

EF600SA



product: alternating switch - no. 6 = type: 250 V~/10 AX = type of mounting: on the wall = version: 1 button stairway, waterproof = IP rating: IP54 = colour: grey-black = packaging: 1 pc, PE packet

A1398.1

1/5/-/60

31 04 139 811

EF602S
(EF602SA)



product: serial switch no. 5 (chandelier) = type: 250 V~/10 AX = type of mounting: on the wall = version: 2 buttons classic water-resistant = IP rating: IP54 = colour: grey-black = packaging: 1 pc, PE packet

A1398.2

1/5/-/60

19 50 011 202

EF600SB



product: cross switch no. 7 = type: 250 V~/10 AX = type of mounting: on the wall = version: 1 button = IP rating: IP54 = colour: grey-black = packaging: 1 pc, PE packet

A1399

1/5/-/60

19 50 011 201

EF600SD



product: switch controller (1/0) = type: 250 V~/10 A = type of mounting: on the wall = version: 1 button = IP rating: IP54 = colour: grey-black = packaging: 1 pc, PE packet



www.emos.eu

Order Code
Item Number

Packaging
Type



A1396 1/5/-/60
31 04 139 600 EF600G





product: socket with earthing pin and lid = design: SCHUKO = type: 250 V~/16 A max. = type of mounting: on the wall = version: single water-resistant = IP rating: IP44 = colour: grey-black = packaging: 1 pc, PE packet

A1398.3 1/5/-/60
19 50 011 203 EF600SA-B

product: alternating switch no. 6 = type: 250 V~/10 AX = type of mounting: on the wall = version: 1 button stairway, waterproof = IP rating: IP54 = colour: white = packaging: 1 pc, PE packet



A1396.1 1/5/-/25
31 04 139 611 EF602G









product: double socket with earthing pins and lids with interconnection = design: SCHUKO = type: 250 V~/16 A max. = type of mounting: on the wall = version: double water-resistant = IP rating: IP44 = colour: grey-black = packaging: 1 pc, PE packet

A1398.4 1/5/-/60
19 50 011 204 EF602S-B

product: serial switch no. 5 (chandelier) = type: 250 V~/10 AX = type of mounting: on the wall = version: 2 buttons classic water-resistant = IP rating: IP54 = colour: white = packaging: 1 pc, PE packet

A1396.2 1/5/-/25
19 50 011 207 EF600SAG







product: combination of alternating switch nr.6 and socket with earthing pin and lid = design: SCHUKO = type: socket 250 V~/16 A max.; switch 250 V~, 10AX = type of mounting: on the wall = version: double water-resistant - 1x socket + 1x alternating switch = IP rating: IP44 = colour: grey-black = packaging: 1 pc, PE packet

Scene switches GoSmart

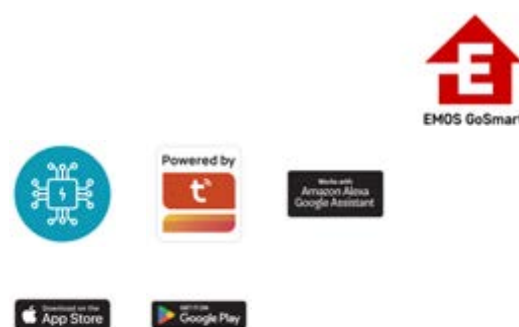
- Control multiple electrical devices or lights at once
- Define trigger events for individual buttons
- Long power supply battery life - up to 2 years
- Installation without pulling electrical cables
- Three-position buttons - press, double press, long press
- Communication via Zigbee protocol
- Compatible with EMOS GoSmart products and TUYA devices
- Voice control with Google Assistant and Amazon Alexa

- product: IP Smart Scene Switcher
- connectivity: ZigBee 2.4 GHz
- compatibility: EMOS GoSmart, TUYA, LIDL, Smartlife
- protocol: Zigbee 3.0
- pairing: automatic, manual
- use: automation
- number of control buttons: 1
- power supply: CR 2430 3 V
- supported OS: Android, iOS



H5011 1/-/-/60
30 69 050 110 IP-2001ZW





www.emos.eu

Order Code
Item Number

Packaging
Type

- product: IP Smart Scene Switcher
- connectivity: ZigBee 2.4 GHz
- compatibility: EMOS GoSmart, TUYA, LIDL, Smartlife
- protocol: Zigbee 3.0
- pairing: automatic, manual
- use: automation
- number of control buttons: 2
- power supply: CR 2430 3 V
- supported OS: Android, iOS



H5012 1/-/-/60
30 69 050 120 IP-2002ZW

- product: IP Smart Scene Switcher
- connectivity: ZigBee 2.4 GHz
- compatibility: EMOS GoSmart, TUYA, LIDL, Smartlife
- protocol: Zigbee 3.0
- pairing: automatic, manual
- use: automation
- number of control buttons: 4
- power supply: CR 2430 3 V
- supported OS: Android, iOS



H5013 1/-/-/60
30 69 050 130 IP-2004ZW

- product: IP Smart Scene Switcher
- connectivity: ZigBee 2.4 GHz
- compatibility: EMOS GoSmart, TUYA, LIDL, Smartlife
- protocol: Zigbee 3.0
- pairing: automatic, manual
- use: automation
- number of control buttons: 1
- power supply: CR 2430 3 V
- supported OS: Android, iOS



H5014 1/-/-/60
30 69 050 140 IP-2001ZB

- product: IP Smart Scene Switcher
- connectivity: ZigBee 2.4 GHz
- compatibility: EMOS GoSmart, TUYA, LIDL, Smartlife
- protocol: Zigbee 3.0
- pairing: automatic, manual
- use: automation
- number of control buttons: 2
- power supply: CR 2430 3 V
- supported OS: Android, iOS



H5015 1/-/-/60
30 69 050 150 IP-2002ZB

- product: IP Smart Scene Switcher
- connectivity: ZigBee 2.4 GHz
- compatibility: EMOS GoSmart, TUYA, LIDL, Smartlife
- protocol: Zigbee 3.0
- pairing: automatic, manual
- use: automation
- number of control buttons: 4
- power supply: CR 2430 3 V
- supported OS: Android, iOS



H5016 1/-/-/60
30 69 050 160 IP-2004ZB

Modules GoSmart



- Remote control of connected devices
- Integration into home automation
- Variants for connection with or without the need for a neutral wire
- Easy installation under original switches
- Connection to the home network via WIFI/ZigBee protocol
- Compatibility with EMOS GoSmart products and TUYA devices
- Voice control with Google Assistant and Amazon Alexa



- product: IP switching module
 - connectivity: ZigBee 2.4 GHz
 - compatibility: EMOS GoSmart, TUYA, LIDL, Smartlife
 - control by voice assistants
 - protocol: Zigbee 3.0
 - pairing: automatic, manual
 - use: indoor
 - number of control buttons: 1
 - power supply: 230 V~/50 Hz, max. 0,3 W
- supported OS: Android, iOS



H5101

1/-/-/100

30 69 051 010

IP-2101SZ

- product: IP switching module
 - connectivity: ZigBee 2.4 GHz
 - compatibility: EMOS GoSmart, TUYA, LIDL, Smartlife
 - control by voice assistants
 - protocol: Zigbee 3.0
 - pairing: automatic, manual
 - use: indoor
 - number of control buttons: 1
 - power supply: 230 V~/50 Hz, max. 0,3 W
- supported OS: Android, iOS



H5102

1/-/-/100

30 69 051 020

IP-2102SZ

- product: IP switching module
 - connectivity: ZigBee 2.4 GHz
 - compatibility: EMOS GoSmart, TUYA, LIDL, Smartlife
 - control by voice assistants
 - protocol: Zigbee 3.0
 - pairing: automatic, manual
 - use: indoor
 - number of control buttons: 1
 - power supply: 230 V~/50 Hz, max. 0,3 W
- supported OS: Android, iOS



H5103

1/-/-/100

30 69 051 030

IP-2103SZ

- product: IP switching module
 - connectivity: ZigBee 2.4 GHz
 - compatibility: EMOS GoSmart, TUYA, LIDL, Smartlife
 - control by voice assistants
 - protocol: Zigbee 3.0
 - pairing: automatic, manual
 - use: indoor
 - number of control buttons: 1
 - power supply: 230 V~/50 Hz, max. 0,3 W
- supported OS: Android, iOS



H5104

1/-/-/100

30 69 051 040

IP-2104SZ



www.emos.eu

Order Code
Item Number

Packaging
Type

- product: IP switching module
 - connectivity: 2.4 GHz WIFI
 - compatibility: EMOS GoSmart, TUYA, LIDL, Smartlife
 - control by voice assistants
 - protocol: Wi-Fi
 - pairing: automatic, manual
 - use: indoor
 - number of control buttons: 1
 - power supply: 230 V~/50 Hz, max. 0,3 W
- = supported OS: Android, iOS



H5105
30 69 051 050

1/-/-100
IP-2101SW



- product: IP switching module
 - connectivity: 2.4 GHz WIFI
 - compatibility: EMOS GoSmart, TUYA, LIDL, Smartlife
 - control by voice assistants
 - protocol: Wi-Fi
 - pairing: automatic, manual
 - use: indoor
 - number of control buttons: 1
 - power supply: 230 V~/50 Hz, max. 0,3 W
- = supported OS: Android, iOS



H5106
30 69 051 060

1/-/-100
IP-2102SW



- product: IP dimming module
 - connectivity: ZigBee 2.4 GHz
 - compatibility: EMOS GoSmart, TUYA, LIDL, Smartlife
 - control by voice assistants
 - protocol: Zigbee 3.0
 - pairing: automatic, manual
 - use: indoor
 - number of control buttons: 1
 - power supply: 230 V~/50 Hz, max. 0,3 W
- = supported OS: Android, iOS



H5107
30 69 051 070

1/-/-100
IP-2111DZ



- product: IP dimming module
 - connectivity: ZigBee 2.4 GHz
 - compatibility: EMOS GoSmart, TUYA, LIDL, Smartlife
 - control by voice assistants
 - protocol: Zigbee 3.0
 - pairing: automatic, manual
 - use: indoor
 - number of control buttons: 1
 - power supply: 230 V~/50 Hz, max. 0,3 W
- = supported OS: Android, iOS



H5108
30 69 051 080

1/-/-100
IP-2112DZ



- product: IP motor module
 - connectivity: ZigBee 2.4 GHz
 - compatibility: EMOS GoSmart, TUYA, LIDL, Smartlife
 - control by voice assistants
 - protocol: Zigbee 3.0
 - pairing: automatic, manual
 - use: indoor
 - number of control buttons: 1
 - power supply: 230 V~/50 Hz, max. 0,3 W
- = supported OS: Android, iOS



H5109
30 69 051 090

1/-/-100
IP-2121CZ





www.emos.eu

Order Code
Item Number

Packaging
Type

- product: IP motor module
 - connectivity: ZigBee 2.4 GHz
 - compatibility: EMOS GoSmart, TUYA, LIDL, Smartlife
 - control by voice assistants
 - protocol: Zigbee 3.0
 - pairing: automatic, manual
 - use: indoor
 - number of control buttons: 1
 - power supply: 230 V~/50 Hz, max. 0,3 W
- = supported OS: Android, iOS



H5110
30 69 051 100

1/-/-100
IP-2122CZ



- product: IP motor module
 - connectivity: 2.4 GHz WIFI
 - compatibility: EMOS GoSmart, TUYA, LIDL, Smartlife
 - control by voice assistants
 - protocol: Wi-Fi/BLE
 - pairing: automatic, manual
 - use: indoor
 - number of control buttons: 1
 - power supply: 230 V~/50 Hz, max. 0,3 W
- = supported OS: Android, iOS



H5111
30 69 051 110

1/-/-32
IP-2131SW



Installation material

Terminal blocks

- terminal blocks with brass contacts
- conductor diameter: 12×4mm², 12×6mm², 12×10mm², 12×16mm²
- rated current: 32 A, 41 A, 57 A or 76 A

A4001
31 46 000 250

10/-/-800
KL 0



product: terminal block = for conductor cross-section: 12× 1-4 mm² = current: 32 A =
rated voltage: 450 V~ = packaging: 10 pcs, foil

A4002
31 46 000 400

10/-/-500
KL 1

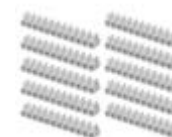

product: terminal block = for conductor cross-section: 12× 1.5-6 mm² = current: 41 A =
rated voltage: 450 V~ = packaging: 10 pcs, foil





www.emos.eu

Order Code
Item Number



Packaging
Type

A4003 10/-/-/350
31 46 000 600 KL 2



product: terminal block = for conductor cross-section: 12× 2.5–10 mm² = current: 57 A
= rated voltage: 450 V~ = packaging: 10 pcs, foil

A4004 10/-/-/200
31 46 001 600 KL 3



product: terminal block = for conductor cross-section: 12× 2.5–16 mm² = current: 76 A
= rated voltage: 450 V~ = packaging: 10 pcs, foil

A4005 1/-/-/300
31 46 010 400 KL 0



product: terminal block = for conductor cross-section: 12× 1–4 mm² = current: 32 A
= rated voltage: 450 V~ = packaging: 1 pc, packet

A4006 1/-/-/200
31 46 010 600 KL 1

product: terminal block = for conductor cross-section: 12× 1.5–6 mm² = current: 41 A
= rated voltage: 450 V~ = packaging: 1 pc, packet

A4007 1/-/-/150
31 46 011 000 KL 2





product: terminal block = for conductor cross-section: 12× 2.5–10 mm² = current: 57 A
= rated voltage: 450 V~ = packaging: 1 pc, packet

Installation material others

- safety plug + key

A9000 1/-/-/12
31 99 900 000 4FF53902.431/S





product: 5× safety cap for sockets + key for the cap = type: 4FF53902.431/S = type of mounting: into a socket = version: cap for sockets + key for the cap = colour: white = packaging: 1 pc, hanging

Transformer solders, copper, rosin



- for DIY and professionals, made in Czech Republic
- suitable for so-called soft soldering, welding smaller parts
- with 125 W input power, 4 soldering tips, LED light
- rosin, soldering tip or tin (1.5 mm diameter) also available

A5102 1/-/-/6
31 47 010 020 ETP 5



product: transformer soldering iron - LED lighting = number of soldering tips: 4 = power: 125 W = packaging: 1 pc, blister

A5201 5/-/-/2 500
31 47 020 010 HR5 CU



product: soldering tip copper for soldering irons 1.3 mm diameter = number of soldering tips: 5 = packaging: 5 pcs, PVC packet

A5301 1/-/-/500
31 47 030 010 KLF 16G

product: rosin for soldering = packaging: 1 pc, PVC packet

A5401 1/-/-/500
31 47 040 010 CN 1,5 10G

product: tube lead-free solder filled with active rosin Sn99,3Cu0,7Nip, diameter 1,5mm, approx. 1 = packaging: 1 pc, PVC packet

Tapes

Electroinsulating PVC tapes

- width: 15–25 mm, length: 10–20 m, thickness: 0.13 mm
- white, red, black, brown, blue, green, yellow or mix
- meets ROHS and REACH (certification for automotive industry)
- adhesion 1.5 N/10 mm², dielectric strength 40 kV/mm²

- tape type: PVC
- width: 19 mm
- length: 10 m
- thickness: 0.13 mm
- electric strength - minimum: 40 kV/mm
- flame tests: less than 1 second
- recommended storage temperature: 10–45 °C
- installation temperature range: -25–90 °C
- ROHS compliant

- REACH compliant
- UV resistant
- adhesive material: rubber
- intended use: cable insulation
- dimensions: 60 × 20 mm
- packaging: 10 pcs, foil



F61912 10/-/-/300
20 01 191 020 19/10 CERNA

- tape type: PVC
- width: 25 mm
- length: 10 m
- thickness: 0.13 mm
- electric strength - minimum: 40 kV/mm
- flame tests: less than 1 second
- recommended storage temperature: 10–45 °C
- installation temperature range: -25–90 °C
- ROHS compliant

- REACH compliant
- UV resistant
- adhesive material: rubber
- intended use: cable insulation
- dimensions: 60 × 25 mm
- packaging: 10 pcs, foil



F62512 10/-/-/300
20 01 251 020 25/10 CERNA

- tape type: PVC
- width: 15 mm
- length: 10 m
- thickness: 0.13 mm
- electric strength - minimum: 40 kV/mm
- flame tests: less than 1 second
- recommended storage temperature: 10–45 °C
- installation temperature range: -25–90 °C
- ROHS compliant

- REACH compliant
- UV resistant
- adhesive material: rubber
- intended use: cable insulation
- dimensions: 60 × 15 mm
- packaging: 10 pcs, foil



F61511 10/-/-/360
20 01 151 010 15/10 BÍLÁ

- tape type: PVC
- width: 15 mm
- length: 10 m
- thickness: 0.13 mm
- electric strength - minimum: 40 kV/mm
- flame tests: less than 1 second
- recommended storage temperature: 10–45 °C
- installation temperature range: -25–90 °C
- ROHS compliant

- REACH compliant
- UV resistant
- adhesive material: rubber
- intended use: cable insulation
- dimensions: 60 × 15 mm
- packaging: 10 pcs, foil



F61512

10/-/-/360

20 01 151 020

15/10 CERNA



- tape type: PVC
- width: 15 mm
- length: 10 m
- thickness: 0.13 mm
- electric strength - minimum: 40 kV/mm
- flame tests: less than 1 second
- recommended storage temperature: 10–45 °C
- installation temperature range: -25–90 °C
- ROHS compliant

- REACH compliant
- UV resistant
- adhesive material: rubber
- intended use: cable insulation
- dimensions: 60 × 15 mm
- packaging: 10 pcs, foil



F61513

10/-/-/360

20 01 151 030

15/10 CERVENA



- tape type: PVC
- width: 15 mm
- length: 10 m
- thickness: 0.13 mm
- electric strength - minimum: 40 kV/mm
- flame tests: less than 1 second
- recommended storage temperature: 10–45 °C
- installation temperature range: -25–90 °C
- ROHS compliant

- REACH compliant
- UV resistant
- adhesive material: rubber
- intended use: cable insulation
- dimensions: 60 × 15 mm
- packaging: 10 pcs, foil



F61514

10/-/-/360

20 01 151 040

15/10 MODRA



- tape type: PVC
- width: 15 mm
- length: 10 m
- thickness: 0.13 mm
- electric strength - minimum: 40 kV/mm
- flame tests: less than 1 second
- recommended storage temperature: 10–45 °C
- installation temperature range: -25–90 °C
- ROHS compliant

- REACH compliant
- UV resistant
- adhesive material: rubber
- intended use: cable insulation
- dimensions: 60 × 15 mm
- packaging: 10 pcs, foil



F61515

10/-/-/360

20 01 151 050

15/10 ZEL/ZLUTA



- tape type: PVC
- width: 15 mm
- length: 10 m
- thickness: 0.13 mm
- electric strength - minimum: 40 kV/mm
- flame tests: less than 1 second
- recommended storage temperature: 10–45 °C
- installation temperature range: -25–90 °C
- ROHS compliant

- REACH compliant
- UV resistant
- adhesive material: rubber
- intended use: cable insulation
- dimensions: 60 × 15 mm
- packaging: 10 pcs, foil



F61516

10/-/-/360

20 01 151 060

15/10 ZLUTA



- tape type: PVC
- width: 15 mm
- length: 10 m
- thickness: 0.13 mm
- electric strength - minimum: 40 kV/mm
- flame tests: less than 1 second
- recommended storage temperature: 10–45 °C
- installation temperature range: -25–90 °C
- ROHS compliant

- REACH compliant
- UV resistant
- adhesive material: rubber
- intended use: cable insulation
- dimensions: 60 × 15 mm
- packaging: 10 pcs, foil



F61517 10/-/-/360
20 01 151 070 15/10 HNEDA



- tape type: PVC
- width: 15 mm
- length: 10 m
- thickness: 0.13 mm
- electric strength - minimum: 40 kV/mm
- flame tests: less than 1 second
- recommended storage temperature: 10–45 °C
- installation temperature range: -25–90 °C
- ROHS compliant

- REACH compliant
- UV resistant
- adhesive material: rubber
- intended use: cable insulation
- dimensions: 60 × 15 mm
- packaging: 10 pcs, foil



F61519 10/-/-/360
20 01 151 090 15/10 GREEN



- tape type: PVC
- width: 15 mm
- length: 10 m
- thickness: 0.13 mm
- electric strength - minimum: 40 kV/mm
- flame tests: less than 1 second
- recommended storage temperature: 10–45 °C
- installation temperature range: -25–90 °C
- ROHS compliant

- REACH compliant
- UV resistant
- adhesive material: rubber
- intended use: cable insulation
- dimensions: 60 × 150 mm
- packaging: 10 pcs, foil



F615992 10/-/-/360
20 01 151 092 15/10 COLOR MIX



- tape type: PVC
- width: 19 mm
- length: 20 m
- thickness: 0.13 mm
- electric strength - minimum: 40 kV/mm
- flame tests: less than 1 second
- recommended storage temperature: 10–45 °C
- installation temperature range: -25–90 °C
- ROHS compliant

- REACH compliant
- UV resistant
- adhesive material: rubber
- intended use: cable insulation
- dimensions: 70 × 20 mm
- packaging: 10 pcs, foil



F61921 10/-/-/200
20 01 192 010 19/20 BILA



- tape type: PVC
- width: 19 mm
- length: 20 m
- thickness: 0.13 mm
- electric strength - minimum: 40 kV/mm
- flame tests: less than 1 second
- recommended storage temperature: 10–45 °C
- installation temperature range: -25–90 °C
- ROHS compliant

- REACH compliant
- UV resistant
- adhesive material: rubber
- intended use: cable insulation
- dimensions: 70 × 20 mm
- packaging: 10 pcs, foil



F61922 10/-/-/200
20 01 192 020 19/20 CERNA



- tape type: PVC
- width: 19 mm
- length: 20 m
- thickness: 0.13 mm
- electric strength - minimum: 40 kV/mm
- flame tests: less than 1 second
- recommended storage temperature: 10–45 °C
- installation temperature range: -25–90 °C
- ROHS compliant

- REACH compliant
- UV resistant
- adhesive material: rubber
- intended use: cable insulation
- dimensions: 70 × 20 mm
- packaging: 10 pcs, foil



F61923 10/-/-/200
20 01 192 030 19/20 CERVENA



- tape type: PVC
- width: 19 mm
- length: 20 m
- thickness: 0.13 mm
- electric strength - minimum: 40 kV/mm
- flame tests: less than 1 second
- recommended storage temperature: 10–45 °C
- installation temperature range: -25–90 °C
- ROHS compliant

- REACH compliant
- UV resistant
- adhesive material: rubber
- intended use: cable insulation
- dimensions: 70 × 20 mm
- packaging: 10 pcs, foil



F61924 10/-/-/200
20 01 192 040 19/20 MODRA



- tape type: PVC
- width: 19 mm
- length: 20 m
- thickness: 0.13 mm
- electric strength - minimum: 40 kV/mm
- flame tests: less than 1 second
- recommended storage temperature: 10–45 °C
- installation temperature range: -25–90 °C
- ROHS compliant

- REACH compliant
- UV resistant
- adhesive material: rubber
- intended use: cable insulation
- dimensions: 70 × 20 mm
- packaging: 10 pcs, foil



F61925 10/-/-/200
20 01 192 050 19/20 ZEL/ZLUTA



- tape type: PVC
- width: 19 mm
- length: 20 m
- thickness: 0.13 mm
- electric strength - minimum: 40 kV/mm
- flame tests: less than 1 second
- recommended storage temperature: 10–45 °C
- installation temperature range: -25–90 °C
- ROHS compliant

- REACH compliant
- UV resistant
- adhesive material: rubber
- intended use: cable insulation
- dimensions: 70 × 20 mm
- packaging: 10 pcs, foil



F61926 10/-/-/200
20 01 192 060 19/20 ZLUTA



- tape type: PVC
- width: 19 mm
- length: 20 m
- thickness: 0.13 mm
- electric strength - minimum: 40 kV/mm
- flame tests: less than 1 second
- recommended storage temperature: 10–45 °C
- installation temperature range: -25–90 °C
- ROHS compliant

- REACH compliant
- UV resistant
- adhesive material: rubber
- intended use: cable insulation
- dimensions: 70 × 20 mm
- packaging: 10 pcs, foil



F61927 10/-/-/200
20 01 192 070 19/20 BROWN





www.emos.eu

Order Code
Item Number

Packaging
Type

- tape type: PVC
- width: 19 mm
- length: 20 m
- thickness: 0.13 mm
- electric strength - minimum: 40 kV/mm
- flame tests: less than 1 second
- recommended storage temperature: 10–45 °C
- installation temperature range: -25–90 °C
- ROHS compliant

- REACH compliant
- UV resistant
- adhesive material: rubber
- intended use: cable insulation
- dimensions: 70 × 20 mm
- packaging: 10 pcs, foil



F61929 10/-/-/200
20 01 192 090 19/20 ZELENA



- tape type: PVC
- width: 19 mm
- length: 20 m
- thickness: 0.13 mm
- electric strength - minimum: 40 kV/mm
- flame tests: less than 1 second
- recommended storage temperature: 10–45 °C
- installation temperature range: -25–90 °C
- ROHS compliant

- REACH compliant
- UV resistant
- adhesive material: rubber
- intended use: cable insulation
- dimensions: 70 × 200 mm
- packaging: 10 pcs, foil



F61999 10/-/-/200
20 01 192 099 19/20 MIX 10KS



Other tapes

- textile, marking and reflective tapes also available
- self-amalgamating tapes: material rubber or silicone
- universal DUCT TAPE: strong, high adhesion, water-tightness
- reflective tapes: increase biker, pedestrian and pram safety
- double-sided acrylic tapes: high adhesion and flexibility

length: 1 m = recommended storage temperature: 10–45 °C = adhesive material: synthetic adhesive = UV resistant = packaging: 1 pc, paper box = intended use: pools, hobby, workshop, garden = installation temperature range: -25–90 °C = ROHS compliant = width: 100 mm = thickness: 0.7 mm = tape type: PVC base



F6100 1/-/-/32
20 05 061 000 POOLREPAIR
TRANSPARENT



length: 1 m = recommended storage temperature: 10–45 °C = adhesive material: synthetic adhesive = UV resistant = packaging: 1 pc, paper box = intended use: pools, hobby, workshop, garden = installation temperature range: -25–90 °C = ROHS compliant = width: 100 mm = thickness: 0.7 mm = tape type: PVC base



F6110 1/-/-/32
20 05 061 100 POOLREPAIR
BLACK



length: 25 m = recommended storage temperature: 10–45 °C = adhesive material: acrylic = UV resistant = packaging: 1 pc, paper box = intended use: repairs of all types of polycarbonates, repairs of glass panes = installation temperature range: -25–90 °C = ROHS compliant = width: 50 mm = thickness: 0.15 mm = tape type: PE base



F6200 1/-/-/30
20 05 062 000 GREENHOUSE TAPE

length: 3 m = recommended storage temperature: 10–45 °C = adhesive material: acrylic = packaging: 1 pc, paper box = intended use: hobby, home interior = installation temperature range: 5–80 °C = ROHS compliant = width: 20 mm = thickness: 1.00 mm = tape type: PE foam



F6090 1/-/-/80
20 05 060 900 IZOTAPE FOAM

length: 3 m = recommended storage temperature: 10–45 °C = adhesive material: acrylic = packaging: 1 pc, paper box = intended use: hobby, home interior = installation temperature range: 5–80 °C = ROHS compliant = width: 30 mm = thickness: 2 mm = tape type: acrylic double-sided tape



F6300 1/-/-/30
20 05 063 000 EM-2303N

tape type: asphalt textile tape = width: 15 mm = length: 15 m = thickness: 0.4 mm = electric strength - minimum: 1 kV/mm = recommended storage temperature: -5 °C to +40 °C = installation temperature range: 5–40 °C = UV resistant = adhesive material: asphalt = integrated textile mesh = dimensions: 80 × 17 mm = packaging: 1 pc, PVC hanging



F6515 1/-/-/60
20 02 151 520 15/15 CERNA

tape type: asphalt textile tape = width: 19 mm = length: 10 m = thickness: 0.4 mm = electric strength - minimum: 1 kV/mm = recommended storage temperature: -5 °C to +40 °C = installation temperature range: 5–40 °C = UV resistant = adhesive material: asphalt = integrated textile mesh = dimensions: 70 × 17 mm = packaging: 1 pc, PVC hanging



F6910 1/-/-/60
20 02 191 020 19/10 CERNA

tape type: self-amalgamating tape = width: 19 mm = length: 10 m = thickness: 0.76 mm = electric strength - minimum: 14 kV/mm = recommended storage temperature: -50 °C to +95 °C = installation temperature range: 5-95 °C = adhesive material: rubber = intended use: sealing, repairs = dimensions: 120 × 20 mm = packaging: 1 pc, paper box



F51912 1/-/5/30
20 03 191 020 19/10
SELFUSING

tape type: self-amalgamating tape = width: 25 mm = length: 5 m = thickness: 0.76 mm = electric strength - minimum: 14 kV/mm = recommended storage temperature: -50 °C to +95 °C = installation temperature range: 5-95 °C = adhesive material: rubber = intended use: sealing, repairs = dimensions: 95 × 28 mm = packaging: 1 pc, paper box



F52502 1/-/5/30
20 03 250 520 25/5 SELFUSING

tape type: silicone vulcanisation = width: 25 mm = length: 3 m = thickness: 0.60 mm = electric strength - minimum: 8 kV/mm = flame tests: less than 1 second = installation temperature range: -60-260 °C = UV resistant = creates pressure-tight joint = intended use: hobby, workshop, garden, repair in vehicle engine compartment, emergency repair of pipes, hoses = dimensions: 60 × 30 mm = packaging: 1 pc, blister



F52503 1/-/20/80
20 03 250 320 25/3 SILICONE

tape type: universal adhesive DUCT TAPE = width: 48 mm = length: 10 m = thickness: 0.21 mm = recommended storage temperature: -20 °C to +80 °C = installation temperature range: 5-80 °C = UV resistant = adhesive material: synthetic rubber = intended use: hobby, workshop, garden = integrated textile mesh: 70 fibers = dimensions: 105 × 48 mm = packaging: 10 pcs, display box



F6030 10/-/50
20 02 502 002 48/10 UNITAPE

tape type: LDPE (low-density polyethylene) warning tape = width: 75 mm = length: 250 m = thickness: 0.03 mm = recommended storage temperature: 5-30 °C = installation temperature range: 5-30 °C = UV resistant = intended use: border of excavations, demarcation of building spaces, sports tracks, various dangerous locations = dimensions: 140 × 75 mm = packaging: 1 pc, paper unwinding mechanism



F87525 1/-/18
20 04 752 500 75/250 BARRIER

tape type: acrylic double-sided tape = width: 12 mm = length: 3 m = thickness: 1.00 mm = recommended storage temperature: 5-40 °C = installation temperature range: 5-40 °C = UV resistant = adhesive material: acrylic = intended use: hobby, workshop, garden = dimensions: 88 × 12 mm = packaging: 1 pc, blister



F6060 1/-/10/60
20 06 000 000 12/3 ACRYL

tape type: acrylic double-sided tape = width: 18 mm = length: 3 m = thickness: 1.00 mm = recommended storage temperature: 5-40 °C = installation temperature range: 5-40 °C = UV resistant = adhesive material: acrylic = intended use: hobby, workshop, garden = dimensions: 88 × 18 mm = packaging: 1 pc, blister



F6080 1/-/10/60
20 06 000 010 18/3 ACRYL

tape type: reflexive safety tape = width: 25 mm = length: 2 m = thickness: 0.19 mm = recommended storage temperature: -20 °C to +80 °C = installation temperature range: -25-90 °C = UV resistant = adhesive material: rubber = intended use: hobby, cycling, safety element = dimensions: 53 × 53 × 25 mm = packaging: 12 pcs, display box



F6070 12/-/-/216
20 05 000 010 25/2 REFLEX TAPE

Order Code	Item Number	page	Order Code	Item Number	page
Z0Z516R	15 25 753 502	139	ZT1521E	15 46 138 401	150
Z0Z832R	15 25 750 500	112	ZT1531	15 46 138 500	151
Z0Z832R	15 25 750 500	140	ZT1621	15 46 138 600	151
ZR1433	15 44 104 032	173	ZT1621E	15 46 138 601	151
ZR1532	15 44 104 820	175	ZT1631	15 46 138 700	151
ZR1642	15 44 103 428	175	ZT3020	15 46 135 700	153
ZR1722	15 44 212 730	176	ZT3120	15 46 135 800	153
ZR2212	15 41 181 200	174	ZT3220	15 46 135 900	153
ZR5410	15 44 213 670	178	ZT4320	15 46 137 700	152
ZR9001	15 42 009 001	182	ZT4420	15 46 137 800	152
ZR9002	15 42 009 002	182	ZT4520	15 46 137 900	152
ZR9010	15 42 009 010	182	ZU083	15 46 138 000	148
ZR9011	15 42 009 011	182	ZU133	15 46 138 100	148
ZR9020	15 42 009 020	182	ZU166	15 46 138 200	148
ZR9021	15 42 009 021	182	ZU225	15 46 138 300	149
ZR9034	15 42 009 034	183	ZU310.12	15 46 139 200	146
ZR9035	15 42 009 035	183	ZU310.6	15 46 139 000	145
ZR9036	15 44 100 000	175	ZU310.9	15 46 139 100	146
ZR9036	15 44 100 000	183	ZU315.12	15 46 139 500	146
ZR9041	15 44 300 001	178	ZU315.6	15 46 139 300	146
ZR9041	15 44 300 001	183	ZU315.9	15 46 139 400	146
ZR9310	15 48 931 000	225	ZU320.12	15 46 139 800	147
ZS2110	15 31 211 010	229	ZU320.6	15 46 139 600	147
ZS2120	15 31 211 020	229	ZU320.9	15 46 139 700	147
ZS2130	15 31 211 030	229	ZU9001	15 46 009 001	149
ZS2140	15 31 211 040	230	ZU9002	15 46 009 002	149
ZS2213	15 31 221 300	165	ZU9003	15 46 009 003	149
ZS2221.2	15 31 222 120	170	ZU9004	15 46 009 004	150
ZS2223	15 31 222 300	165	ZU9005	15 46 009 005	150
ZS2231.2	15 31 223 120	170	ZU9902	15 46 009 902	149
ZS2233	15 31 223 300	165	ZV1112	15 40 110 621	217
ZS2243	15 31 224 300	166	ZV1122	15 40 110 820	217
ZS2313	15 31 231 300	166	ZV1132	15 40 111 120	217
ZS2323	15 31 232 300	166	ZV1142	15 40 111 520	218
ZS2333	15 31 233 300	166	ZV1152	15 40 112 220	218
ZS2343	15 31 234 300	166	ZV1160	15 40 116 500	219
ZS2413	15 31 241 300	155	ZV1161	15 40 146 500	219
ZS2423	15 31 242 300	155	ZV2112	15 40 210 621	218
ZS2433	15 31 243 300	156	ZV2122	15 40 210 820	218
ZS2443	15 31 244 300	156	ZV2132	15 40 211 120	218
ZS2443A	15 31 244 310	156	ZV2142	15 40 211 520	219
ZS2453	15 31 245 300	156	ZV2152	15 40 212 220	219
ZS2453A	15 31 245 310	156	ZZ1435T	15 60 014 350	183
ZS2463	15 31 246 300	157	ZZ2055T	15 60 020 550	183
ZS2463A	15 31 246 310	157	ZZ3070T	15 60 030 700	184
ZS2473	15 31 247 300	157	ZZ409BD	15 60 040 900	184
ZS2510	15 31 252 510	161			
ZS2511	15 31 242 511	163			
ZS2520	15 31 252 520	161			
ZS2521	15 31 242 521	163			
ZS2530	15 31 252 530	161			
ZS2531	15 31 242 531	163			
ZS2540	15 31 252 540	162			
ZS2541	15 31 242 541	163			
ZS2612	15 31 242 612	158			
ZS2622	15 31 242 622	158			
ZS2632	15 31 242 632	158			
ZS2642	15 31 242 642	159			
ZS2652	15 31 242 652	159			
ZS2662	15 31 242 662	159			
ZS2672	15 31 242 672	159			
ZS2712	15 31 242 712	159			
ZS2722	15 31 242 722	160			
ZS2732	15 31 242 732	160			
ZS2742	15 31 242 742	160			
ZS2812	15 31 281 200	170			
ZS2822	15 31 282 200	171			
ZS2832	15 31 283 200	171			
ZS2910	15 31 252 910	162			
ZS2911	15 31 242 911	164			
ZS2920	15 31 252 920	162			
ZS2921	15 31 242 921	164			
ZS2930	15 31 252 930	162			
ZS2931	15 31 242 931	164			
ZS2940	15 31 252 940	162			
ZS2941	15 31 242 941	164			
ZS3322	15 42 033 220	169			
ZS3332	15 42 033 320	169			
ZS3342	15 42 033 420	169			
ZS3360S	15 42 033 601	168			
ZS9010	15 31 900 010	167			
ZS9020	15 31 900 020	167			
ZS9030	15 31 900 030	167			
ZS9510	15 31 950 010	168			
ZT1040	15 46 138 800	151			
ZT1521	15 46 138 400	150			



Item Number	Order Code	page	Item Number	Order Code	page
30 24 040 630	H4063	6	32 32 226 500	KT2265	256
30 24 040 630	H4063	348	32 32 322 300	KT3223	257
30 24 040 640	H4064	6	32 32 336 400	KT3364	257
30 24 040 640	H4064	348	32 32 356 400	KT3564	257
30 24 040 650	H4065	6	32 33 012 100	KE1210	259
30 24 040 650	H4065	349	32 33 012 400	KE1240	258
30 69 050 010	H5001	15	32 33 012 800	KE1280	258
30 69 050 010	H5001	341	32 33 019 160	KE1916	259
30 69 050 110	H5011	14	32 33 029 810	KE2981	258
30 69 050 110	H5011	375	32 33 049 100	KE4910	259
30 69 050 120	H5012	14	32 33 049 110	KE4911	259
30 69 050 120	H5012	376	32 33 049 120	KE4912	259
30 69 050 130	H5013	14	32 33 049 130	KE4913	260
30 69 050 130	H5013	376	32 33 049 140	KE4914	260
30 69 050 140	H5014	15	32 33 068 200	KE6820	258
30 69 050 140	H5014	376	32 33 079 551	KE7955N	260
30 69 050 150	H5015	15	34 01 000 010	P57001	355
30 69 050 150	H5015	376	34 01 000 020	P57002	355
30 69 050 160	H5016	15	34 02 005 000	P5705	351
30 69 050 160	H5016	376	34 02 012 000	P5712	351
30 69 050 230	H5023	8	34 02 025 000	P5727	350
30 69 050 230	H5023	346	34 02 043 000	P5728	351
30 69 051 010	H5101	17	34 02 044 000	P5729	352
30 69 051 010	H5101	377	34 02 060 000	P5760	350
30 69 051 020	H5102	17	34 02 060 001	P5763	350
30 69 051 020	H5102	377	34 02 060 002	P5760T	354
30 69 051 030	H5103	17	34 02 063 000	P5763R	350
30 69 051 030	H5103	377	34 02 107 000	P5723	351
30 69 051 040	H5104	18	34 02 108 000	P5723T	354
30 69 051 040	H5104	377	34 02 112 000	P5727T	354
30 69 051 050	H5105	18	34 02 113 000	P5728T	354
30 69 051 050	H5105	378	34 02 114 000	P5729T	354
30 69 051 060	H5106	18	34 02 115 000	P5730	351
30 69 051 060	H5106	378	34 02 116 000	P5731	352
30 69 051 070	H5107	18	34 02 117 001	P5732T	355
30 69 051 070	H5107	378	34 02 118 000	P5750	349
30 69 051 080	H5108	18	34 02 118 001	P5750T	353
30 69 051 080	H5108	378	34 02 119 000	P5750.2T	349
30 69 051 090	H5109	19	34 02 120 000	P5750.2R	350
30 69 051 090	H5109	378	34 02 121 000	P5729B	352
30 69 051 100	H5110	19	34 02 122 000	P5733W	352
30 69 051 100	H5110	379	34 02 123 000	P5733S	352
30 69 051 110	H5111	19	34 02 124 000	P5733G	353
30 69 051 110	H5111	379	34 02 125 000	P5734	353
30 69 052 010	H5020	9	34 02 126 000	P5734B	353
30 69 052 010	H5020	356	34 02 126 001	P5734T	355
30 69 052 020	H5021	9			
30 69 052 020	H5021	356			
30 69 052 030	H5022	16			
30 69 052 030	H5022	341			
30 70 000 009	H7009	346			
30 80 000 013	H8013	346			
31 04 139 600	A1396	375			
31 04 139 611	A1396.1	375			
31 04 139 800	A1398	374			
31 04 139 811	A1398.1	374			
31 05 213 050	A6110	288			
31 05 213 051	A6111	288			
31 05 213 054	A6114	288			
31 05 213 055	A6115	288			
31 06 213 150	A6310	288			
31 06 213 151	A6311	288			
31 06 213 152	A6312	288			
31 06 213 153	A6313	288			
31 06 213 240	A6210	287			
31 06 213 241	A6211	288			
31 06 213 242	A6212	287			
31 06 213 243	A6213	288			
31 16 300 400	A3004	326			
31 16 301 000	A3010	326			
31 16 336 600	A3366	326			
31 16 336 900	A3369	326			
31 32 510 900	C5109	141			
31 46 000 250	A4001	379			
31 46 000 400	A4002	379			
31 46 000 600	A4003	380			
31 46 001 600	A4004	380			
31 46 010 400	A4005	380			
31 46 010 600	A4006	380			
31 46 011 000	A4007	380			
31 47 010 020	A5102	381			
31 47 020 010	A5201	381			
31 47 030 010	A5301	381			
31 47 040 010	A5401	381			
31 99 900 000	A9000	380			
32 32 224 400	KT2244	257			



Button and special batteries

GP SILVER OXIDE					Diameter [mm]	Thickness [mm]	ALKALINE				
GP order code	Type	Reference	SR**	SR***			GP order code	AG**	101 - 199	LR**	LR***
-	317	SR516SW, SR62, SR516, SB-AR, 280-58, V317, D317, GP317, 616, 317, SR516W, 317X, 317A	SR62	SR516	5,8	1,6	-	-	-	-	-
-	321	SR616SW, SR65, SR616, SB-AF/DF, 280-73, DA, V321, D321, GP321, 611, 321, SR618, 321A, 321X, SB-AF, E321	SR65	SR616	6,8	1,6	-	-	-	-	-
B3357F1	357	SR44W, SR44, SR1154, SB-B9, 280-62, V357, D357, 228, S1145E, GP357, AG13, 357, 303, CA18, SG13, EPX76, 10L14, A357, 357X, 357A, D357H, MS76, V76XP, S76E, 357/303, MS76, AG357, SR1154PW, EXP76, E357, E357/303EN, 1128MP, 1166A, AG13, D76A, G13A, GPA7, GPA76, LR44, LR1154, L1154, PX675A, PX76A, RPX675, S76, V13GA, RW82, KA, A76, 208-904, SB-F9, G13-A, CA18, CA19, LR44, GP76A, L1154H, A-76, AG14, AG-14, KA76, MS76H, CR44, LR44H, L1154G, LR44G, GPS76A, L1154C, L1154F, GPA75, GDA76, A613, LR44GD	SR44	SR1154	11,6	5,4	B13762 B1376 B7970 (RAVER)	AG13	A76	LR44	LR1154
-	362	SR721SW, SR58, SR721, SB-AK/DK, 280-29, S, V362, D362, 601, S721E, GP362, AG11, AG-11, 362, SG11, 362A, SR720, 362X, 362/361, RW310, L721, LR721, SB-AK, E362	SR58	SR721	7,9	2,1	-	AG11	162	LR58	LR721
B3364F1	364	SR621SW, SR60, SR621, SB-AG/DG, 280-34, T, V364, D364, 602, S621E, GP364, AG1, AG-1, 364, L621, LR621, SG1, LR60, LR620, SW621, GP164, 364X, 364A, AG1/364A, SB-AG, E364	SR60	SR621	6,8	2,1	-	AG1	164	LR60	LR621
-	371	SR920SW, SR69, SR921, SB-AN, 280-31, V371, D371, 605, S921E, GP371, AG6, AG-6, 371, CX921, SR290SW, 371, SR69, SG6, LR921, LR920SW, L921, 371A, 371X, 370	SR69	SR921	9,5	2,1	-	AG6	171	LR69	LR921
B3377F1	377	SR626SW, SR66, SR626, SB-AW, 280-39, BA, V377, D377, 606, S626E, GP377, AG4, AG-4, 377, L626, SG4, LR626, LR66, SR628SW, E377, E377CA, LR626SW, 377A, SR262SW, 377X, 377S, GP177, SR6265W, 377/376, E377A, SR66SW, SR625SW, 377BA, CR626SW, AG4/377, AG04	SR66	SR626	6,8	2,6	-	AG4	177	LR66	LR626
-	379	SR521SW, SR63, SR521, SB-AC/DC, 280-59, JA, V379, D379, 618, GP379, S521E, 379, LR521, AG0, 379A, 379X, AG0, AG-0, 521A, UC379, SR418SW, SB-AC, 379LD, E379	SR63	SR521	5,8	2,1	-	AG0	179	LR63	LR521
-	386	SR43W, SR43, SR1142, SB-B8, 280-41, H, V386, D386, 260, S1142E, GP386, AG12, AG-12, 386, 301, SG12, LR42, 386A, 386X, CR43, LR1144, RW44, SR1142PW, 386B, BSR43H, SR43H, E386, 186, 1176A, 186-1, G12A, GP86A, L1142, LR1142, LR43, RW84, V12GA, GP186, L1142F, 10L124, G12-A	SR43	SR1142	11,6	4,2	B13861 B1386	AG12	186	LR43	LR1142
B3389F1	389	SR1130W, SR54, SR1130, SB-BU, 280-15, M, V389, D389, 626, S1131E, GP389, AG10, AG-10, 389, 390, 189, L1131, G10, V10GA, LR1130, GP189, LR54, SG10, A389, L1131, L1131C, L1131D, RW89, LR1130S, LR1131, L1131/D, LR1130H, 389A, 389E, 389X, L1133, SR1131, L1131, L1131F, L1131F, L1131H, LR1130X, L-1131, SR1130PW, L1130, LH1130, E389	SR54	SR1130	11,6	3,1	B13892 B1389	AG10	189	LR54	LR1130
B3392F1	392	SR41W, SR736, SB-B1, 280-13, K, V392, D392, 247D, S736E, AG3, AG-3, GP392, LR736, 392, 192, L736, G3, V3GA, LR41, SG3, ASG3, G3A, V36A, 92A, GP192, 392X, 384, SR41, TR41SW, SR41SW, 247B, SP392, S736S, 392A, 392X, L736H, L736S, SR736PW, RW47, RW47S, GP392-A1, SR41, E392, LR41H, AG03	SR41	SR736	7,9	3,6	B13921 B13925	AG3	192	LR41	LR736
-	394	SR936SW, SR936, SB-A4, 280-17, V394, D394, 625, 394, GP394, AG9, AG-9, 394, SG9, LR36, LR936, SR45, RW33, 394A, 394X, SR9365W, E394		SR936	9,5	3,6	-	AG9	194	LR45	LR936
-	395	SR926SW, SR57, SR927, SB-AP/DP, 280-48, LA, V395, D395, 610, 395, GP395, S926E, 395, SG7, L926, SW927, 927, 395A, 395X, SB-AP, E395, 399	SR57	SR927	9,5	2,6	-	AG7	195	LR57	-
-	396	SR726W, SR59, SR726, SB-BL, 280-52, V, V396, D396, 612, GP396, S726E, 396/397, SG2, 396A, 396X, SR726PW, E396	SR59	SR726	7,9	2,6	-	AG2	106	LR59	-
-	-	V23GA, MN21, A23	-	-	10,22	28,5	B1300 B13001	-	-	-	-
-	-	A27, MN24, A90	-	-	8	28,5	B1301 B13011	-	-	-	-
-	-	MN11	-	-	10,22	16,5	B1302 B13021	-	-	-	-
-	-	29A, A29, 32A, A32, L822	-	-	8,0	21,9	B13951	-	-	-	-
-	-	4001, AM5, E90, KN, LADY, LR1, MN9100, MN9100/N, N, UM-5, UM5, LR01, KN-2, 810, 910A, LR1-N, LR1/E90	-	-	12	30,2	B1305	-	-	LR1	-
-	-	LR9, CA16, V625U, EPX625G, PX625A, GP625A, A625, L1560, 625A, MR9P, KA625, R625, E625G, V625U, MR09, EPX625, RPX625, KX615, HD1560, 1124MP, E625N, HG-625R, V13PX, EPX13, V625PX, HD625, PN625, RM625, 4625, H1560, M01, M20, 8930	-	-	15,6	5,95	B1325	-	-	LR9	-
-	-	GP25A, AAAA, MN2500, LR8, D425, E96	-	-	8,3	42,5	B1306	-	-	LR8	-
-	-	PX28A, A544, 28PXA, 4LR44, 476A, 4G13, GP476, K28, V28, PX28AB, L1325, 1414A, V4034PX, PX28L, K28L, L544, L544BP, V28PXL, 2CR1/3N, 2CR1-3N, CR28L, 1406LC, 2CR11108	-	-	13	25,2	B1303	-	-	4LR44	-



Lead-acid accumulators – 5-year optimal service life	Order code	B9641	B9651	B9659	B9682	B9652	B9672	B9653	B9679	B9691
	Parameters	6 V/4 Ah	6 V/1.3 Ah	6 V/7 Ah	6 V/12 Ah	12 V/1.3 Ah	12 V/2.2 Ah	12 V/4.5 Ah	12 V/5 Ah	12 V/7.0 Ah
	Terminal	4.7 mm	4.7 mm	4.7 mm	4.7 mm	4.7 mm	4.7 mm	4.7 mm	6.3 mm	4.7 mm
Electronic security systems	Electronic security systems	-	yes	yes	yes	yes	yes	yes	yes	yes
	Electronic fire alarm systems	-	yes	yes	yes	yes	-	yes	yes	yes
	UPS	-	-	yes	yes	-	-	yes	yes	yes
	Emergency lighting	yes	-	-	-	-	-	-	-	yes
	Elevators – power for emergency calls and lighting	-	-	-	-	yes	-	yes	yes	yes
Jablotron control panels	JA82Y	-	-	-	-	-	yes	-	-	-
	JA100K(R)	-	-	-	-	-	yes	-	-	-
	JA83	-	-	-	-	-	-	-	-	yes
	JA106K	-	-	-	-	-	-	-	-	yes
PARADOX	90 % use	-	-	-	-	-	-	-	-	yes
	10 % use	-	-	-	-	-	-	-	-	-



Lead-acid accumulators – 5-year optimal service life	Order code	B9654	B9674	B9675	B9656V	B9656	B9655	B9683	B9684	B9685
	Parameters	12 V/7.2 Ah	12 V/7.2 Ah	12 V/9 Ah	12 V/15 Ah	12 V/12 Ah	12 V/18 Ah	12 V/26 Ah	12 V/40 Ah	12 V/65 Ah
	Terminal	4.7 mm	6.3 mm	6.3 mm	6.3 mm	6.3 mm	12 × 12 × 2 mm	14 × 12 × 2 mm	M6	M8
Electronic security systems	Electronic security systems	yes	yes	-	-	yes	yes	-	-	-
	Electronic fire alarm systems	yes	-	-	-	yes	yes	-	-	-
	UPS	yes	yes	yes	-	yes	yes	yes	yes	yes
	Emergency lighting	yes	-	-	-	-	yes	yes	yes	yes
	Elevators – power for emergency calls and lighting	yes	-	-	-	yes	yes	-	-	-
Jablotron control panels	JA82Y	-	-	-	-	-	-	-	-	-
	JA100K(R)	yes	-	-	-	-	-	-	-	-
	JA83	yes	-	-	-	-	yes	-	-	-
	JA106K	yes	-	-	-	-	yes	-	-	-
PARADOX	90 % use	yes	-	-	-	-	-	-	-	-
	10 % use	-	-	-	-	-	yes	-	-	-

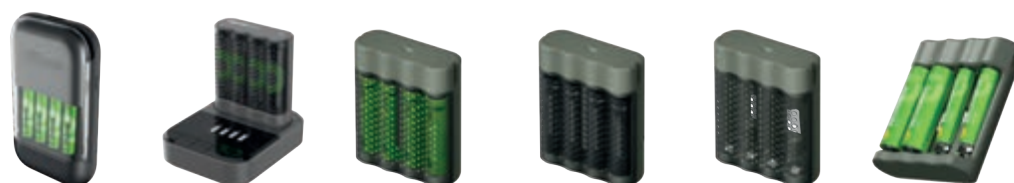

Order code	B56499	B50460D	B53457	B53455	B53450	B50449
Model number	S491	P461	M451	M451	M451	B441
Series	Charge 10	Pro	Speed	Speed	Speed	Recharge
Charger connection	separated AC cord	USB	USB	USB	USB	USB
Power supply	100-240 V AC	USB 5 V/2 A	5 V/1 A	5 V/1 A	5 V/1 A	USB 5 V/1 A
Size of the charged cells	AAA, AA	AAA, AA	AAA, AA	AAA, AA	AAA, AA	AAA, AA
Special features	Eco mode	capacity check, docking station	-	-	-	-
Number of cells inside the package	4	4	4	4	-	4
Type of cells inside the package	AA ReCyko Charge 10	AA ReCyko Pro	AA ReCyko 2 700	AA ReCyko Pro	-	AA Recharge 1300, AAA Recharge 650
Charging time of the enclosed celled	0:10	1:20 - 2:40	2:45 - 5:30	2:00 - 4:00	-	2:00 - 4:00
Number of charging channels	4	4	4	4	4	2
Number of batteries charged	1 to 4	1 up to 4	1 to 4	1 to 4	1 to 4	2 or 4
Charging current for AA	10 000 mA	1 730 mA/870 mA	1 100-550 mA	1 100-550 mA	1 100-550 mA	770 mA/380 mA
Charging current for AAA	1 500 mA	700 mA/350 mA	730-370 mA	730-370 mA	730-370 mA	300 mA
Charging current for C	-	-	-	-	-	-
Charging current for D	-	-	-	-	-	-
Charging current for 9 V	-	-	-	-	-	-
Charging time AA 2 700 mAh	0:30	1:45/3:30	2:45 - 5:30	2:45 - 5:30	2:45 - 5:30	4:00 - 8:00
Charging time AAA 1 000 mAh	0:45	1:30 - 3:15	1:30 - 3:30	1:30 - 3:30	1:30 - 3:30	4:00



Order code	B55630	B50829	B50444	B51214	B50224	B50457
Model number	B631	E821	B441	E211	E221	M452
Series	Everyday	Economy	Economy	Economy	Economy	Speed
Charger connection	USB	USB	USB	USB	USB	USB
Power supply	5 V/2 A	USB 5 V/1 A	USB 5 V/1 A	5 V/1 A	USB 5 V/1 A	USB 5 V/1 A
Size of the charged cells	AAA, AA, C, D, 9 V	AAA, AA	AAA, AA	AAA, AA	AAA, AA	AAA, AA
Special features	-	-	-	-	-	-
Number of cells inside the package	-	8	4	2	2	4
Type of cells inside the package	-	AA ReCyko 2 100, AAA ReCyko 850	AA ReCyko 2 100	AA ReCyko 2 100	AA ReCyko 2 100	AA ReCyko Pro
Charging time of the enclosed celled	-	9:00	3:00/6:00	8:00	8:00	2:45 - 5:30
Number of charging channels	4	4	2	1	1	4
Number of batteries charged	2 and 4	2, 4, 6 or 8	2 or 4	2	2	1 up to 4
Charging current for AA	370 mA	250 mA	770 mA/380 mA	300 mA	300 mA	1 100-550 mA
Charging current for AAA	290 mA	250 mA	300 mA	300 mA	300 mA	730-370 mA
Charging current for C	550 mA	-	-	-	-	-
Charging current for D	550 mA	-	-	-	-	-
Charging current for 9 V	40-20 mA	-	-	-	-	-
Charging time AA 2 700 mAh	8:00	10:00	4:00 - 8:00	10:00	10:00	2:45 - 5:30
Charging time AAA 1 000 mAh	4:00	5:00	2:30 - 3:30	4:00	4:00	1:30 - 3:30



Order code	N9221	N9341	N9331	N9321	N9361
Type	BCL-20D	BCN-42D	BCN-41D	BCN-40	BCN-60U
Type of rechargeable cells	Li-ion, LiFePo4, NiMH	NiMH	NiMH	NiMH	NiMH
Power supply	5 V/2 A	5 V/1 A	5 V/1 A	5 V/1 A	5 V/2 A
Size of the charged cells	10440 – 26650, AAA, AA, C, SC	AAA, AA	AAA, AA	AAA, AA	AAA, AA, C, D, 9 V
Special features	capacity measurement, recovery modes, lithium battery charging	capacity measurement, recovery modes	-	-	-
LCD display	yes	yes	yes	-	-
Type of cells inside the package	-	4× AA NiMH 2 700	4× AA NiMH 2 700	-	-
Charging time of the individual cells	-	3:00	4:00	-	-
Number of charging channels	2	4	4	4	7
Number of batteries charged	1 and 2	1 to 4	1 to 4	1 to 4	1 to 6
Charging current for AA	1 000 mA	1 000–250 mA	1 000–500 mA	300 mA	500 mA
Charging current for AAA	1 000 mA	1 000–250 mA	1 000–500 mA	300 mA	500 mA
Charging current for C	1 000 mA	-	-	-	500 mA
Charging current for D	-	-	-	-	500 mA
Charging current for 9 V	-	-	-	-	30 mA
Charging time AA 2 700 mAh	3:00	3:00 – 12:00	3:00 – 4:00	10:00	6:30
Charging time AAA 1 000 mAh	1:15	1:15 – 5:00	1:15 – 2:00	4:00	2:30



Order code	P8569	P8555	P8567	P8566	P8572	P8571
Type	PHR19	CHR35	PHR17	PHR16	CHR41	CH46
Usage	OUTDOOR	OUTDOOR	SPORT	SPORT	OUTDOOR/SPORT	OUTDOOR/SPORT
Source of light	2× Osram SMD LED	CREE SMD LED	3× CREE SMD LED	2× CREE SMD LED	CREE SMD LED	CREE SMD LED
Max. light output	1 200 lm	600 lm	500 lm	300 lm	300 lm	300 lm
Max. beam distance	110 m	130 m	85 m	50 m	157 m	157 m
Number of lighting modes	11	5	10	9	4	4
Lighting modes	Turbo; Spot: 5%; 20%; 60%; 100%; Flood: 2.5%; 10%; 60%; 100%; SOS; Red LED light	Turbo, 100%, 20%, 5%, red LED flashing	Turbo, 2.5%, 30%, 100%; SOS, Red LED light, Flood, red: 50%, 100%, flashing	Turbo, 3%, 25%, 100%; SOS, Red LED light, red: 50%, 100%, flashing	AUTO, 100%, 50%, 2% flicker	100%, 50%, 2%, flicker
Max. luminous time	100 h	60 h	100 h	45 h	69 h	69 h
Rechargeable	yes	yes	yes	yes	yes	-
Power supply	Li-ion (2 550 mAh) / 2× CR123A	Li-ion (2 600 mAh)	Li-Po (1 600 mAh)	Li-Po (800 mAh)	3× AAA (HR03)	3× AAA
Waterproof	IPX8	IPX4	IPX6	IPX6	IPX6	IPX6
Special features	button lock mode	button lock mode	button lock mode	button lock mode	button lock mode, automatic dimming	touchless dimming
Dimensions	91,5 × 39 × 51 mm	106 × 27 × 27 mm	56 × 38 × 39 mm	56 × 38 × 34 mm	34 × 46 × 56 mm	34 × 46 × 56 mm
Weight	90/151 g	153 g	59,5 g	44 g	110 g	110 g



Order code	P8574	P8573	P8584	P8583	P8582	P8551P
Type	CHW54	CHW53	CH44	CH43	CH42	CH31
Usage	WORK	WORK	OUTDOOR	OUTDOOR/SPORT	MULTIUSE	MULTIUSE
Source of light	2× CREE SMD LED	2× CREE SMD LED	2× SMD LED	2× SMD LED + LED	2× SMD LED	4× LED
Max. light output	375 lm	280 lm	300 lm	150 lm	110 lm	40 lm
Max. beam distance	110 m	90 m	60 m	45 m	40 m	8 m
Number of lighting modes	4	6	6	5	4	3
Lighting modes	Turbo; 100%, 30%, 17%	Turbo; 100%, 40%, 25%, red LED light, flashing	100%, 60%, 25%, 12%, red LED light, flashing	100%, 45%, 25%, red LED light, flashing	100%, 65%, 40%, flicker	100%, 30%, flicker
Max. luminous time	26 h	25 h	36 h	36 h	15 h	6 h
Rechargeable	-	-	-	-	-	-
Power supply	3× AAA	3× AAA	3× AAA	3× AAA	3× AAA	2× CR2025
Waterproof	IPX5	IPX5	IPX4	IPX4	IP43	-
Special features	touchless dimming	-	touchless light swithing	-	-	-
Dimensions	66 × 49 × 37 mm	66 × 49 × 37 mm	61 × 47 × 37 mm	61 × 47 × 37 mm	59 × 46 × 34 mm	37 × 36 × 20 mm
Weight	62 g/98 g	95 g	42 g/78 g	42 g/78 g	29 g/65 g	31 g



Order code	P3537	P3532	P3528	P3536	P3541
Source of light	COB LED	COB LED (white, red)	COB LED	LED + COB LED (green, red)	COB LED + LED
Maximal light output	110 lm	125 lm	150 lm	220 lm	380 lm
Maximal beam distance	15 m	20 m	20 m	100 m	30 m
Number of lighting modes	3	3	3	7	4
Lighting modes	COB LED 100 %, COB LED 50 %, blinking	COB LED 100 %, COB LED 50 %, COB LED - red blinking	COB LED 100 %, COB LED 50 %, SOS	COB LED + LED 100 %, LED 100 %, LED 50 %, blinking, COB LED - white, COB LED - red, COB LED - green	COB LED 100 %, COB LED 50 %, LED 100 %, LED 50 %
Runtime	20-40 hrs	9-19 hrs	8-27 hrs	45-160 hrs	3-12 hrs
Waterproof	-	IP44	-	IP43	IP43
Rechargeable	-	-	-	-	yes
Power supply	3× AAA	3× AAA	3× AAA	3× AAA	Li-pol (1 200 mAh)
Special features	-	battery protection	-	quick switch ON/OFF	hand-operated switching, quick switch ON/OFF, battery protection
Dimensions	60 × 18 × 40 mm	69 × 43 × 46 mm	60 × 40 × 40 mm	65 × 45 × 50 mm	300 × 3.2 × 20 mm
Weight	21 g/56 g	54 g/89 g	53 g/88 g	65 g/100 g	73 g



Order code	P3521	P3539	P3531	P3534	P3535	P3542
Source of light	LED + 2× red LED	CREE LED + 2× red LED	CREE LED + COB LED (green, red) + red LED (rear light)	CREE LED	CREE LED + 4× SMD	COB LED + LED
Maximal light output	85 lm	330 lm	330 lm	230 lm	110 lm	500 lm
Maximal beam distance	65 m	200 m	65 m	80 m	55 m	130 m
Number of lighting modes	4	5	7	4	3	7
Lighting modes	LED 100 %, LED 50 %, red LED flashing, red LED blinking	CREE LED 100 %, CREE LED 50 %, SOS, red LED flashing, red LED blinking	COB LED + CREE LED 100 %, CREE LED 100 %, CREE LED 50 %, CREE LED - blinking, COB LED - white, COB LED - green, COB LED - red	CREE LED 100 %, CREE LED 50 %, CREE LED 20 %, SOS	CREE LED 100 %, CREE LED 50 %, 4× SMD LED	LED 25 %, LED 50 %, LED 100 %, COB LED 25 %, COB LED 50 %, COB LED 100 %, LED + COB LED
Runtime	50-120 hrs	50-87 hrs	18-72 hrs	3-13 hrs	7 h	4-6.5 hrs
Waterproof	IP43	IP43	IP44	-	ano	yes
Rechargeable	-	-	-	yes	Li-pol (850 mAh)	Li-pol
Power supply	3× AAA	3× AAA	3× AAA + 1× CR2032	Li-pol (1 200 mAh)	-	yes (IP44)
Special features	quick switch ON/OFF	quick switch ON/OFF, focus	quick switch ON/OFF	hand-operated switching, quick switch ON/OFF, battery protection	funkce rychlého vypnutí, funkce ochrany baterie	hand-operated switching, quick switch ON/OFF, battery protection
Dimensions	58 × 38 × 44 mm	60 × 48 × 43 mm	65 × 32 × 39 mm	61 × 37 × 31 mm	47 × 31 × 54 mm	70 × 45 × 35 mm
Weight	54 g/89 g	70 g/105 g	80 g/115 g	60 g	64 g	90 g



Order code	P4536	P4533	P4534	P4539	P4532	P4525	P4518	P4535	P4538
Type	RECHARGEABLE								
Source of light	2× COB LED	COB LED	COB LED	COB LED	COB LED + LED	COB LED + 5× LED	COB LED + LED	2× COB LED + LED	SMD LED + LED
Maximal light output	2 000 lm	1 000 lm	600 lm	1 000 lm	470 lm	500 lm	380 lm	670 lm	700 lm
Maximal beam distance	70 m	45 m	35 m	40 m	45 m	30 m	27 m	40 m	45 m
Number of lighting modes	5	3	2	3	3	3	3	3	3
Lighting modes	2× COB LED 100 %, 2× COB LED 50 %, 1× COB LED 100 %, 1× COB LED 50 %, 1× COB LED 25 %	COB LED 100 %, COB LED 50 %, COB LED 20 %	COB LED 100 %, COB LED 50 %	COB LED 100 %, COB LED 50 %, COB LED 25 %	COB LED 100 %, COB LED 50 %, LED	COB LED 50 %, COB LED 100 %, 5× LED	COB LED 50 %, COB LED 100 %, LED 100 %	1× COB LED 100 %, 2× COB LED 100 %, LED 100 %	SMD LED BOOST, SMD LED 100 %, LED 100 %
Runtime	3.5–14.5 hrs	3.5–15.5 hrs	2.5–3.5 hrs	3–17 hrs	2.5–8 hrs	2–26 hrs	3.5–24 hrs	2–10 hrs	3–6 hrs
Focus	–	–	–	–	–	–	–	–	–
Shock-resistance	yes	yes	yes	yes	yes	yes	yes	–	–
Waterproof	–	yes (IP44)	yes (IP44)	yes (IP44)	–	yes (IP43)	yes (IP43)	–	–
Rechargeable	yes	yes	yes	yes	yes	yes	yes	yes	yes
Power supply	Li-Ion accumulator	Li-Ion accumulator	Li-Ion accumulator	Li-Ion	Li-Ion accumulator	Li-Ion accumulator	Li-Ion accumulator	Li-Ion accumulator	Li-Ion
Battery type	8 000 mAh/3.7 V	4 400 mAh/3.7 V	3 000 mAh/3.7 V	2 200 mAh/3.7 V	1 800 mAh/3.7 V	2 000 mAh/3.7 V	2 500 mAh/3.7 V	2 200 mAh/3.7 V	1 200 mAh/3.7 V
Batteries included	yes	yes	yes	yes	yes	yes	yes	yes	yes
Charging time	7 hrs	7.5 hrs	3.5 hrs	3 hrs	3.5 hrs	3 hrs	4 hrs	3 hrs	2 hrs
Power connector type	USB-C	micro USB-B	micro USB-B	USB-C	5.5 × 2.1/10 mm	3.0 × 1.0/12 mm	3.0 × 1.0/12 mm	USB-C	USB-C
Led indication of the charging process	yes	yes	yes	yes	yes	yes	yes	yes	yes
Led indication of the accumulator state	yes	yes	yes	–	–	–	–	yes	yes
Special features	quick switch ON/OFF, battery protection	quick switch ON/OFF, battery protection	battery protection, powerbank function	powerbank function, quick switch ON/OFF, battery protection	quick switch ON/OFF, battery protection	quick switch ON/OFF, battery protection	quick switch ON/OFF, battery protection	powerbank function, quick switch ON/OFF, battery protection	battery protection function, light BOOST function
Facilities	swivel handle, 4× magnet	swivel handle	swivel handle	magnet, stand, clip	swivel handle, clip, 1× hook, 2× magnet	swivel handle, 1× hook, 3× magnet	swivel handle, 1× hook, 2× magnet	1× hook, 4× magnet	2× magnet
Accessories	USB cable	USB cable	USB cable	USB cable	charging adapter	charging adapter + car adapter	charging adapter, car adapter	USB cable	USB cable
Material	ABS plastic + rubber	ABS plastic + rubber	Nylon + TPR	ABS plastic	ABS plastic + rubber	ABS plastic + rubber	ABS plastic	ABS + TPR + rubber	ABS plastic + rubber
Dimensions	214 × 140 (280) × 56 mm	172 × 45 × 126 mm	172 × 45 × 126 mm	104 × 39 × 94 mm	52 × 41 × 242 mm	76 × 66 × 317 mm	56 × 50 × 240 mm	35 × 33 × 257 mm	37 × 14 × 240 mm



Order code	P4537	P4531	P4540	P4541	P4542	P4543	P4113	P4112	P3888
Type	RECHARGEABLE						BATTERY		
Source of light	COB LED + SMD LED	COB LED + LED	COB LED + LED	COB LED + LED	COB LED cool + COB LED warm	COB LED	COB LED	2× COB LED + LED	COB LED
Maximal light output	330 lm	400 lm	750 lm	450 lm	900 lm	1 200 lm	700 lm	350 lm	180 lm
Maximal beam distance	45 m	40 m	35 m	100 m	35 m	60 m	35 m	110 m	45 m
Number of lighting modes	3	3	6	3	16	3	3	2	2
Lighting modes	COB LED 100 %, COB LED 33 %, SMD LED 100 %	COB LED 100 %, COB LED 50 %, LED 100 %	COB LED 100 %, COB LED 40 %, COB LED 20 %, red COB LED glow, red COB LED flashing, LED 100 %	COB LED 100 % + LED 100 %, COB LED 100 %, LED 100 %	4× COB LED 100 %, 75 %, 50 %, 25 % (warm/neutral/cool)	COB LED 100 %, COB LED 30 %, flashing	COB LED 35 %, COB LED 60 %, COB 100 %	2× COB LED 100 %, LED 100 %	COB LED 100 %, COB LED 50 %
Runtime	3–7 hrs	3–8.5 hrs	2–13 hrs	7–16 hrs	3.5–12.5 hrs	3.5–6.5 hrs	8–14 hrs	10–20 hrs	16–24 hrs
Focus	–	–	–	–	–	–	–	–	–
Shock-resistance	yes	yes	yes	yes	yes	yes	yes	–	yes
Waterproof	yes (IP43)	yes (IP43)	yes (IP44)	yes (IP44)	–	yes (IP44)	yes (IP43)	–	–
Rechargeable	yes	yes	yes	yes	yes	yes	–	–	–
Power supply	Li-Ion	Li-Ion accumulator	Li-Ion	Li-Ion	Li-Ion	Li-pol	4× AA	3× AA	3× AAA
Battery type	1 200 mAh/3.7 V	2 000 mAh/3.7 V	1 800 mAh/3.7 V	2 000 mAh/3.7 V	2× 2 000 mAh/3.7 V	2 000 mAh/3.7 V	LR6 (1.5 V)	LR6 (1.5 V)	LR03 (1.5 V)
Batteries included	yes	yes	yes	yes	yes	yes	–	–	–
Charging time	2–4 hrs	3 hrs	2.5 hrs	3.5 hrs	4.5 hrs	3 hrs	–	–	–
Power connector type	micro USB-B	micro USB-B	USB-C	USB-C	USB-C	USB-C	–	–	–
Led indication of the charging process	yes	yes	yes	yes	yes	yes	–	–	–
Led indication of the accumulator state	yes	yes	–	–	yes	yes	–	–	–
Special features	quick switch ON/OFF, battery protection	quick switch ON/OFF, battery protection	quick switch ON/OFF, battery protection	battery protection	battery protection, powerbank	quick switch ON/OFF, battery protection	quick switch ON/OFF	–	–
Facilities	swivel handle, 1× clip, 1× magnet, 1× hook	swivel handle, clip, 1× hook, 1× magnet	rotating reflector, magnet, hook	magnet, hook	magnet, rotating stand, hook	magnet, rotating stand, clip	swivel handle	swivel handle	break-over handle, 1× hook, 2× magnet
Accessories	USB cable	USB cable	USB cable	USB cable	USB cable	USB cable	–	–	–
Material	ABS plastic + rubber	plastic + rubber	plastic	plastic	plastic	plastic	plastic	plastic	ABS plastic
Dimensions	41 × 29 × 154 mm	52 × 32 × 165 mm	28 × 35 × 147/285 mm	43 × 43 × 197 mm	125 × 45 × 95 mm	80 × 45 × 80 mm	145 × 105 × 35 mm	135 × 100 × 40 mm	59 × 30 × 133 mm



	ZS2812	ZS2822	ZS2832
Order code			
Series	ACCO		
Source of light	LED	LED	LED
Power	10 W	20 W	30 W
Light output	1 000 lm	2 000 lm	3 000 lm
Luminous efficiency	100 lm/W	100 lm/W	100 lm/W
Colour temperature	6 500 K	6 500 K	6 500 K
Light colour	cool white	cool white	cool white
IP rating	IP54	IP54	IP54
Colour rendering index (CRI)	Ra > 80	Ra > 80	Ra > 80
Power supply	accumulator	accumulator	accumulator
Battery	Li-Ion 4 400 mAh	Li-Ion 6 600 mAh	Li-Ion 10 000 mAh
AKU lighting time	3 – 10 hours	3 – 10 hours	3 – 10 hours
Voltage	5 V DC 220–240 V AC	5 V DC 220–240 V AC	5 V DC 220–240 V AC
Dimming	yes	yes	yes
Lifetime	25 000 hours	25 000 hours	25 000 hours
Working temperature range	-20 °C to +40 °C	-20 °C to +40 °C	-20 °C to +40 °C
Beam angle	120°	120°	120°
Dimensions	212 × 177 × 224 mm	266 × 220 × 273 mm	292 × 219 × 273 mm
Body material	aluminum	aluminum	aluminum
Material of the diffuser	glass	glass	glass
Mechanical impact protection	-	-	-



	ZS3322	ZS3332	ZS3342	ZS2221.2	ZS2231.2
Order code					
Series		ILIO		HOBBY SLIM	
Source of light	LED	LED	LED	LED	LED
Power	21 W	31 W	51 W	2× 20,5 W	2× 30 W
Light output	1 900 lm	2 800 lm	4 600 lm	2× 1 600 lm	2× 2 400 lm
Luminous efficiency	90 lm/W	90 lm/W	90 lm/W	80 lm/W	80 lm/W
Colour temperature	4 000 K	4 000 K	4 000 K	4 000 K	4 000 K
Light colour	neutral white	neutral white	neutral white	neutral white	neutral white
IP rating	IP44	IP44	IP44	IP65	IP65
Colour rendering index (CRI)	Ra > 80	Ra > 80	Ra > 80	Ra > 80	Ra > 80
Power supply	mains powered	mains powered	mains powered	mains powered	mains powered
Battery	-	-	-	-	-
AKU lighting time	-	-	-	-	-
Voltage	220–240 V~	220–240 V~	220–240 V~	220–240 V~	220–240 V~
Dimming	-	-	-	-	-
Lifetime	25 000 hours	25 000 hours	25 000 hours	25 000 hours	25 000 hours
Working temperature range	-20 °C to +40 °C	-20 °C to +40 °C	-20 °C to +40 °C	-20 °C to +40 °C	-20 °C to +40 °C
Beam angle	110°	110°	110°	120°	120°
Dimensions	215 × 185 × 250 mm	240 × 185 × 275 mm	270 × 185 × 275 mm	860 × 860 × 1 850 mm	860 × 860 × 1 850 mm
Body material	aluminum	aluminum	aluminum	aluminum	aluminum
Material of the diffuser	plastic (PC)	plastic (PC)	plastic (PC)	glass	glass
Mechanical impact protection	IK10	IK10	IK10	IK08	IK08



	H4020	H3010	H2017	H2050
Order code				
Series	GoSmart	ADVANCED	BASIC	
Type	IP-750A	EM-10AHD	EM-07HD	EM-03M 2WIRE
LCD size	7"	7"	7"	7"
LCD resolution	Full HD 1080p	1080p	720p	480p
Button design	without buttons, touchscreen	touchscreen	mechanical	mechanical
Number of conductors	4	4	4	2
Power supply	12 V DC	12 V DC	12 V DC	15 V DC
Memory	yes	yes	-	-
Network features	yes	-	-	-
Lock / gate control	yes/yes	yes/yes	yes/yes	yes/yes
Number of inputs	2× camera unit, 2× CCTV	2× camera unit, 2× CCTV	2× camera unit, 2× CCTV	1× camera unit
Monitor dimensions	175 × 118 × 25 mm	175 × 125 × 20 mm	233 × 23 × 160 mm	152 × 215 × 18 mm
Camera unit dimensions	142 × 44 × 21 mm	135 × 50 × 25 mm	64 × 46 × 145 mm	141 × 63 × 40 mm
View angle	120/160°	120/160°	80°	80°
Type of illumination	IR + IR CUT	IR + IR CUT	IR	IR
Water-resistant camera unit	yes	yes	yes	yes
Shock-resistant camera unit	yes	yes	yes	yes
Intercom	yes	yes	yes	-
Motion detection	yes	yes	-	-



	H4030	H4031	H4032
Order code			
Series	GoSmart		
Type	IP-09D	IP-09C	IP-15S
Camera resolution	1 920 × 1 080	1 920 × 1 080	1 920 × 1 080
Number of buttons	1	1	1
Power supply	Li-Ion battery 2× 18650	12 V DC	5 V DC/1 A, AC 12-24 V
Network features/WiFi	yes	yes	yes
Lock/gate control	yes/-	yes/-	-/-
Camera unit dimensions	149 × 63 × 46 mm	149 × 63 × 46 mm	145 × 57 × 41 mm
Camera viewing angle	110°	110°	130°
Type of illumination	IR + IR CUT	IR + IR CUT	IR
Water-resistant camera unit	yes	yes	yes
Shock-resistant camera unit	-	-	-
Motion detection	yes	yes	yes
Additional indoor bell	yes	yes	yes



Order code	E8010	E6016	E8466	E5111	E6018	E8670	E0387
Version	wireless	wireless	wireless	wireless	wireless	wireless	wireless
Clock	DCF (radio controlled clock)	controlled by DCF signal	controlled by DCF signal	controlled by DCF signal	controlled by DCF signal	controlled by DCF signal	controlled by DCF signal
Display backlight	yes	yes	yes	yes	yes	yes	yes
Wall-mounted	-	yes	-	yes	yes	yes	yes
Electronic panel backlight	yes	yes	-	yes	yes	yes	yes
Time zones	yes	yes	-	yes	yes	yes	yes
Projection	-	-	time and temperature projection	-	-	-	-
Date	yes	yes	yes	yes	yes	yes	yes
Calendar	yes	yes	yes	yes	yes	yes	yes
Alarm clock	yes	yes, 2x	yes, 2x	yes, 2x	yes, 2x	yes	yes
Outside temperature	-50 °C up to +70 °C, to 0,1 °C	-30 °C up +60 °C, to 0,1 °C	-20 °C up +60 °C, to 0,1 °C	-40 °C up +70 °C, to 0,1 °C	-50 °C up +70 °C, to 0,1 °C	-30 °C up +60 °C, to 0,1 °C	-40 °C up +60 °C, to 0,1 °C
Inside temperature	-2 °C up to +50 °C, to 0,1 °C	-10 °C up +50 °C, to 0,1 °C	-5 °C up +50 °C, to 0,1 °C	-10 °C up +50 °C, to 0,1 °C	-10 °C up +50 °C, to 0,1 °C	-10 °C up +50 °C, to 0,1 °C	-10 °C up +50 °C, to 0,1 °C
Outside humidity	20 % up to 95 % RV, to 1 %	1 % up 99 % RV, to 1 %	-	20 % up 95 % RV, to 1 %	1 % up 99 % RV, to 1 %	10 % up 99 % RV, to 1 %	1 % up 99 % RV, to 1 %
Inside humidity	20 % up to 95 % RV, to 1 %	1 % up 99 % RV, to 1 %	-	1 % up 99 % RV, to 1 %	1 % up 99 % RV, to 1 %	10 % up 99 % RV, to 1 %	1 % up 99 % RV, to 1 %
Minimum and maximum temperature	yes	yes	yes	yes	yes	yes	yes
Weather forecast	yes	yes	yes	yes	yes	yes	yes
Temperature warning	yes	yes	-	-	yes	yes	yes
Temperature/pressure trend	yes/yes	yes/yes	yes/-	yes/yes	yes/yes	yes/-	yes/yes
Barometer/precipitation gauge/anemometer	yes/-/-	yes/yes/yes	-/-/-	yes/-/-	yes/-/-	yes/yes/-	yes/-/-
Altitude correction	-	yes	-	-	yes	-	-
Phases of the moon	yes	yes	-	yes	yes	-	yes
Sensor range	up to 100 m	up 100 m	up 30 m	up 50 m	up 100 m	up 50 m	up 80 m
Optional additional sensor	up to 3 sensors (E00387, E05018)	up to 3 temperature and humidity sensors (E06018), 1 anemometer sensor (E06016)	up to 3 sensors (E08400)	up to 3 sensors (E05018)	up to 3 sensors (E06018)	-	up to 3 sensors (E00387)
Wire probe for sensor	-	-	-	yes	-	-	-
Sensor's power supply	2x 1,5 V AAA (not included)	4x 1,5 V AA (not included)	2x 1,5 V AA (not included)	2x 1,5 V AAA (not included)	2x 1,5 V AAA (not included)	2x 1,5 V AA (not included)	2x 1,5 V AA (not included)
Station's power supply	2x 1,5 V AA (not included)	3x 1,5 V AAA (not included)	1x CR2032 (included)	3x 1,5 V AAA (not included)	3x 1,5 V AAA (not included)	3x 1,5 V AAA (not included)	3x 1,5 V AA (not included)
Network adapter	yes, USB-C 9 V DC/2 000 mA, 1,5 m (included)	yes, 5 V DC/300 mA (included)	yes, 4,5 V DC/300 mA (included)	yes, 5 V DC/600 mA (included)	yes, 5 V DC/300 mA (included)	yes, 5 V DC/1 000 mA (included)	yes, 5 V DC/1 200 mA (included)
Dimension of the main unit	133 x 125 x 110 mm	17 x 192 x 127 mm	56 x 163 x 80 mm	26 x 197 x 125 mm	17 x 192 x 127 mm	29 x 205 x 127 mm	30 x 200 x 130 mm
Sensor's dimension	40 x 26 x 104 mm	250 x 160 x 100 mm	35 x 65 x 100 mm	21 x 60 x 100 mm	15 x 62 x 100 mm	117 x 117 x 164 mm	20 x 38 x 100 mm
Display size	110 x 73 mm	168 x 93 mm	102 x 42 mm	164 x 90 mm	168 x 93 mm	169 x 94 mm	168 x 91 mm



Obecné číslo	E8647	E3070	E3003	E0352	E5080	E0117N
Provedení	wireless	wireless	wireless	wireless	wireless	wire
Hodiny	yes, quartz	controlled by DCF signal	controlled by DCF signal	controlled by DCF signal	controlled by DCF signal	yes, quartz
Podsvícení displeje	yes	yes	yes	-	yes	-
Možnost pověšení na zeď	yes	-	-	yes	yes	-
Elektronické plošné podsvícení	yes	-	-	-	yes	-
Časová pásma	-	yes	yes	yes	yes	-
Projekce	-	-	-	-	-	-
Datum	-	yes	yes	yes	yes	yes
Kalendář	-	yes	yes	yes	yes	yes
Budík	yes	yes	yes	yes	yes, 2x	yes
Venkovní teplota	-50 °C up +70 °C, to 0,1 °C	-30 °C up +60 °C, to 0,1 °C	-50 °C up +70 °C, to 0,1 °C	-40 °C up +60 °C, to 0,1 °C	-40 °C up +70 °C, to 0,1 °C	-50 °C up +70 °C, to 0,1 °C
Vnitřní teplota	-10 °C up +50 °C, to 0,1 °C	0 °C up +50 °C, to 0,1 °C	-10 °C up +50 °C, to 0,1 °C	-10 °C up +50 °C, to 0,1 °C	-10 °C up +50 °C, to 0,1 °C	-10 °C up +50 °C, to 0,1 °C
Venkovní vlhkost	20 % up 95 % RV, to 1 %	-	20 % up 95 %, to 1 %	20 % up 95 % RV, to 1 %	20 % up 95 % RV, to 1 %	-
Vnitřní vlhkost	20 % up 95 % RV, to 1 %	20 % up 90 % RV, to 1 %	20 % up 95 %, to 1 %	1 % up 99 % RV, to 1 %	1 % up 99 % RV, to 1 %	20 % up 95 % RV, to 1 %
Min. a max. teplota	yes	-	yes	yes	yes	yes
Předpověď počasí	yes	yes	yes	yes	yes	yes
Teplotní výstraha	-	-	yes	-	-	-
Trend teploty/tlaku	-/-	yes/-	yes/-	yes/-	yes/yes	-/-
Barometr/srážkoměr/anemometr	-/-/-	-/-/-	-/-/-	-/-/-	yes/-/-	-/-/-
Korekce nadmořské výšky	-	-	-	-	yes	-
Fáze měsíce	-	yes	yes	yes	-	yes
Dosah čidla	up 50 m	up 30 m	up 30 m	up 30 m	up 30 m	-
Možné další čidlo	-	up to 3 sensors (E03070)	up to 3 sensors (E05018)	up to 3 sensors (E05018)	up to 3 sensors (E05018)	-
Drátová sonda k čidlu	-	-	-	-	yes	1,9 m
Napájení čidla	2x 1,5 V AAA (not included)	2x 1,5 V AAA (not included)	2x 1,5 V AAA (not included)	2x 1,5 V AA (not included)	2x 1,5 V AAA (not included)	-
Napájení stanice	2x 1,5 V AAA (not included)	3x 1,5 V AAA (not included)	2x 1,5 V AA (not included)	2x 1,5 V AAA (not included)	3x 1,5 V AA (not included)	2x LR1130 (included)
Sítový adaptér	yes, micro USB 5 V/1 A (not included)	-	-	-	-	-
Rozměr hlavní jednotky	20 × 85 × 96 mm	52 × 139 × 100 mm	50 × 120 × 180 mm	23 × 76 × 126 mm	27 × 130 × 130 mm	16 × 70 × 109 mm
Rozměr čidla	25 × 50 × 95 mm	24 × 44 × 100 mm	23 × 60 × 92 mm	21 × 38 × 100 mm	21 × 60 × 100 mm	-
Velikost displeje	65 × 76 mm	111 × 61 mm	80 × 120 mm	50 × 81 mm	105 × 105 mm	45 × 79 mm



Order code	P19223	P19224	P19222	P08215	P19733	P192250	P19220
Inclusion	NEOPRENE CABLE FOR MODERATE MECHANICAL LOAD, OIL-RESISTANT						
Warranty	5 years				2 years		
Conductor	H05VV-F 3 G				H07RN-F5G		H07RN-F 3 G
Conductor diameter	1,5 mm ²	2,5 mm ²	1,5 mm ²	1,5 mm ²	2,5 mm ²	1,5 mm ²	2,5 mm ²
Maximum reeled load	4,35 A max./1 000 W	5,2 A max./1 200 W	4,35 A max./1 000 W	4,35 A max./1 000 W	230 V~: 6,52 A max./1 500 W; 400 V~: 6,25 A max./2 500 W	230 V~: 4,35 A max./1 000 W; 400 V~: 6,25 A max./2 500 W	6,52 A max./1 500 W
Maximum unreeled load	16 A max./3 680 W	16 A max./3 680 W	16 A max./3 680 W	13,04 A max./3 000 W	230 V~: 15,22 A max./3 500 W; 400 V~: 16 A max./6 400 W	230 V~: 13 A max./3 000 W; 400 V~: 12,5 A max./5 000 W	15,22 A max./3 500 W
Length	50 m	40 m	25 m	15 m	33 m	25 m	50 m
Metal body	yes	yes	yes	yes	-	-	-
Suitable for construction sites	yes	yes	yes	yes	yes	yes	yes
Indoor use	yes	yes	yes	yes	yes	yes	yes
Temperature range for cable use	from -25°C to +60°C						
Guide loop for easy cable reeling	yes	yes	yes	yes	-	-	-
Outdoor use	yes IP44						
LED light	-	-	-	20 W/1 600 lm	-	-	-



Order code	P08250	P08225	P19625	P19221
Inclusion	RUBBER CABLE FOR STANDARD MECHANICAL STRESS			
Warranty	2 years			
Conductor	H05RR-F 3 G			
Conductor diameter	1,5 mm ²		2,5 mm ²	
Maximum reeled load	4,8 A max./1 100 W	4,8 A max./1 100 W	6 A max./1 600 W	6,52 A max./1 500 W
Maximum unreeled load	16 A max./3 680 W	16 A max./3 680 W	16 A max./3 680 W	15,22 A max./3 500 W
Length	50 m	25 m	25 m	50 m
Metal body	-	-	-	-
Suitable for construction sites	-	-	-	-
Indoor use	yes	yes	yes	yes
Temperature range for cable use	from -25°C to +60°C			
Guide loop for easy cable reeling	-	-	-	-
Outdoor use	yes IP44			
LED light	-	-	-	-



Order code	P08625W		P08650W		P08620W	
Inclusion	SILICONE CABLE FOR MODERATE MECHANICAL LOADS, ANTI-FREEZE					
Warranty	3 years					
Conductor	AT-N05V3V3-F3G					
Conductor diameter	1,5 mm ²					
Maximum reeled load	4,8 A max./1 100 W	4,8 A max./1 100 W	4,8 A max./1 100 W	4,8 A max./1 100 W	4,35 A max./1 000 W	4,35 A max./1 000 W
Maximum unreeled load	16 A max./3 680 W	16 A max./3 680 W	16 A max./3 680 W	16 A max./3 680 W	13,04 A max./3 000 W	13,04 A max./3 000 W
Length	25 m	50 m	50 m	50 m	20 m	20 m
Metal body	-	-	-	-	-	-
Suitable for construction sites	yes					
Indoor use	yes					
Temperature range for cable use	from -35 °C to 60 °C					
Guide loop for easy cable reeling	yes					
Outdoor use	yes IP44					
LED light	-	-	-	-	yes	yes
Other functions	-	-	-	-	-	2x USB-A output







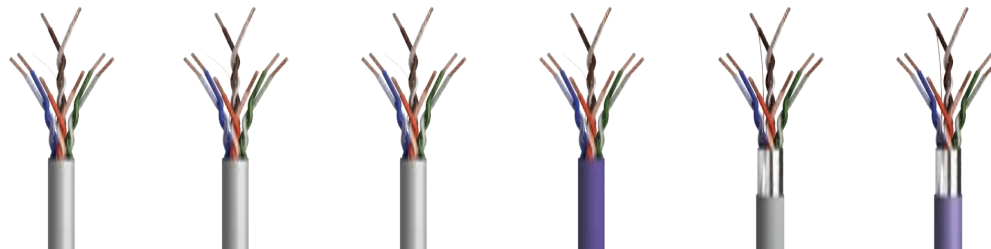

Order code	P19427		P092501		P092251		P09250		P09225		P09240	
Inclusion	PVC CABLE FOR STANDARD MECHANICAL STRESS											
Warranty	2 years											
Conductor	H05VV-F 3 G											
Conductor diameter	1,5 mm ²											
Maximum reeled load	4,35 A max./1 000 W	4,8 A max./1 100 W	4,8 A max./1 100 W	4,8 A max./1 100 W	4,8 A max./1 100 W	4,8 A max./1 100 W	4,8 A max./1 100 W	4,8 A max./1 100 W	4,8 A max./1 100 W	4,8 A max./1 100 W	4,8 A max./1 100 W	4,8 A max./1 100 W
Maximum unreeled load	13 A max./3 000 W	16 A max./3 680 W	16 A max./3 680 W	16 A max./3 680 W	16 A max./3 680 W	16 A max./3 680 W	16 A max./3 680 W	16 A max./3 680 W	16 A max./3 680 W	16 A max./3 680 W	16 A max./3 680 W	16 A max./3 680 W
Length	25 m	50 m	25 m	50 m	25 m	50 m	25 m	50 m	25 m	50 m	25 m	40 m
Temperature range for cable use	from 4 °C to 60 °C											
Guide loop for easy cable reeling	-	yes	yes	yes	yes	yes	yes	yes	yes	yes	yes	yes
Outdoor use	-											







Order code	P09240M		P09225M		P09220		P19515		P19510	
Inclusion	PVC CABLE FOR STANDARD MECHANICAL STRESS									
Warranty	2 years									
Conductor	H05VV-F 3 G									
Conductor diameter	2,5 mm ²					1,0 mm ²				
Maximum reeled load	6 A max./1 380 W	6 A max./1 600 W	6 A max./1 600 W	6 A max./1 600 W	6 A max./1 600 W	4,8 A max./1 100 W	4 A max./920 W	4 A max./920 W	4 A max./920 W	4 A max./920 W
Maximum unreeled load	16 A max./3 600 W	16 A max./3 600 W	16 A max./3 600 W	16 A max./3 600 W	16 A max./3 600 W	10 A max./2 300 W	10 A max./2 300 W	10 A max./2 300 W	10 A max./2 300 W	10 A max./2 300 W
Length	40 m	25 m	25 m	25 m	25 m	20 m	15 m	15 m	15 m	10 m
Temperature range for cable use	from 4 °C to 60 °C									
Guide loop for easy cable reeling	-	-	-	-	-	yes	yes	yes	yes	yes
Outdoor use	-									

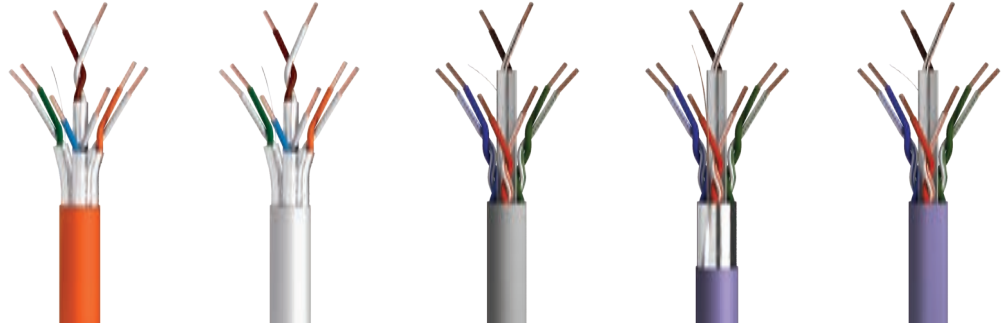

Order code	S9128	S9134	S9121	S9129	S9221	S9222
Type	UTP CAT 5E	UTP CAT 5E	UTP CAT 5E	UTP CAT 5E	F/UTP CAT 5E	F/UTP CAT 5E
DESIGN PARAMETERS						
Twisted pair	4×	4×	4×	4×	4×	4×
Number of wires	4× 2	4× 2	4× 2	4× 2	4× 2 + 1	4× 2 + 1
Shielding	-	-	-	-	aluminium/PET foils	aluminium/PET foils
Foil	-	-	-	-	7/12 – 18 mm	7/12 – 18 mm
Internal conductor	copper-clad aluminium (CCA)	copper wire	copper wire	copper wire	copper wire	copper wire
AWG	24	24	24	24	24	24
Diameter of conductors (mm)	0,51	0,45	0,48	0,48	0,48	0,48
Shielding of conductors	HDPE	HDPE	HDPE	HDPE	HDPE	HDPE
Average thickness (mm)	0,22	0,22	0,22	0,22	0,22	0,22
Strength member	nylon 150D	nylon 150D	nylon 150D	nylon 150D	CuSn wire 0,4 mm	CuSn wire 0,4 mm
Cable jacket	PVC	PVC	PVC	LSOH (LSZH)	PVC	LSOH (LSZH)
Jacket thickness (mm)	1,1	1,1	1,1	1,1	1,1	1,1
Diameter of cable jacket (mm)	5,2	5	5,2	5,2	6	6
Colour	grey	grey	grey	purple	grey	purple
PACKAGING						
Material	 305 m/paper box 5-layer cardboard with print	 305 m/paper box 5-layer cardboard with print	 305 m/paper box 5-layer cardboard with print	 305 m/paper box 5-layer cardboard with print	 305 m/paper box 5-layer cardboard with print	 305 m/paper box 5-layer cardboard with print
MECHANICAL PROPERTIES						
Max. DC insulation resistance	94,8	94,8	94,8	94,8	94,8	94,8
Operating temperature	60	60	60	60	60	60
EU DIRECTIVE						
EU Directive 2011/65	RoHS	RoHS	RoHS	RoHS	RoHS	RoHS
EU Directive 305/2011	CPR	CPR	CPR	CPR	CPR	CPR
MEETS HARMONISED STANDARDS						
	ČSN EN 50173-1 ed. 4:2019 ANSI/EIA/TIA 568A, 568B ISO/IEC 11801 ČSN EN 50575:2015 A1:2017	ČSN EN 50173-1 ed. 4:2019 ANSI/EIA/TIA 568A, 568B ISO/IEC 11801 ČSN EN 50575:2015 A1:2017	ČSN EN 50173-1 ed. 4:2019 ANSI/EIA/TIA 568A, 568B ISO/IEC 11801 ČSN EN 50575:2015 A1:2017	ANSI/EIA/TIA 568A, 568B ISO/IEC 11801 IEC 60754-2 ČSN EN 50173-1 ed. 4:2019 ČSN EN 50575:2015 A1:2017 ČSN EN 60754-1:2015 ČSN EN 60754-2:2015 ČSN EN 60754-1:2015 ČSN EN 60754-2:2015 IEC/ČSN EN 60332-1-2 / IEC/ČSN EN 61034-2	ČSN EN 50173-1 ed. 4:2019 ANSI/EIA/TIA 568A, 568B ISO/IEC 11801 ČSN EN 50575:2015 A1:2017	ANSI/EIA/TIA 568A, 568B ISO/IEC 11801 ČSN EN 50173-1 ed. 4:2019 IEC 60754-2 ČSN EN 50575:2015 A1:2017 ČSN EN 60754-1:2015 ČSN EN 60754-2:2015 IEC/ČSN EN 60332-1-2 ČSN EN 60754-1:2015 IEC/ČSN EN 61034-2
CPR CERTIFICATION						
Euroclass fire rating	Eca	Eca	Eca	Dca-s2-d2-a1	Eca	Dca-s2-d2-a2
Hazardous substances	-	-	-	-	-	-



Order code	S9310	S9320	S9131	S9230	S9132
Type	STP CAT6A	FFTP CAT6A	UTP CAT 6	F/UTP CAT 6	UTP CAT 6
DESIGN PARAMETERS					
Twisted pair	4×	4×	4×	4×	4×
Number of wires	4× 2 + 1	4× 2 + 1	4× 2	4× 2 + 1	4× 2
Shielding	aluminium/PET foils	aluminium/PET foils	-	aluminium/PET foils	-
Foil	7/12 - 18 mm	7/12 - 18 mm	-	7/12 - 18 mm	-
Internal conductor	copper wire	copper wire	copper wire	copper wire	copper wire
AWG	23	23	23	23	23
Diameter of conductors (mm)	0,56	0,56	0,55	0,55	0,55
Shielding of conductors	HDPE	HDPE	HDPE	HDPE	HDPE
Average thickness (mm)	0,22	0,22	0,22	0,22	0,22
Strength member	nylon 150D	nylon 150D	nylon 150D	CuSn wire 0,4 mm	nylon 150D
Cable jacket	LSZH	LSZH	PVC	LSOH (LSZH)	LSOH (LSZH)
Jacket thickness (mm)	1,1	1,1	1,1	1,1	1,1
Diameter of cable jacket (mm)	7,6	7,6	6,3	6,3	6,3
Colour	orange	grey	grey	purple	purple
PACKAGING					
Material	 500 m/ wooden coil	 500 m/ wooden coil	 305 m/ paper box 5-layer cardboard with print	 500 m/ wooden coil	 305 m/ paper box 5-layer cardboard with print
MECHANICAL PROPERTIES					
Max. DC insulation resistance	94,8	94,8	94,8	94,8	94,8
Operating temperature	-20 °C to 60 °C	-20 °C to 60 °C	60	60	60
EU DIRECTIVE					
EU Directive 2011/65	RoHS	RoHS	RoHS	RoHS	RoHS
EU Directive 305/2011	CPR	CPR	CPR	CPR	CPR
MEETS HARMONISED STANDARDS					
	ANSI/EIA/TIA 568A, 568B ISO/IEC 11801 ČSN EN 50173-1 ed. 4:2019 IEC 60754-2 ČSN EN 50575:2015 A1:2017 ČSN EN 60754-1:2015 ČSN EN 60754-2:2015 IEC/ČSN EN 60332-1-2 ČSN EN 60754-1:2015 ČSN EN 60754-2:2015 IEC/ČSN EN 61034-2	ANSI/EIA/TIA 568A, 568B ISO/IEC 11801 ČSN EN 50173-1 ed. 4:2019 IEC 60754-2 ČSN EN 50575:2015 A1:2017 ČSN EN 60754-1:2015 ČSN EN 60754-2:2015 IEC/ČSN EN 60332-1-2 ČSN EN 60754-1:2015 ČSN EN 60754-2:2015 IEC/ČSN EN 61034-2	ČSN EN 50173-1 ed. 4:2019 IEC 61156-5 Ed. 2 ISO/IEC 11801 CLASS ČSN EN 50288-6-1 ed. 2:2014 ANSI/EIA/TIA 568B.2-1 Cat 6 ČSN EN 50575:2015 A1:2017	ANSI/EIA/TIA 568A, 568B ISO/IEC 11801 ČSN EN 50173-1 ed. 4:2019 IEC 60754-2 ČSN EN 50575:2015 A1:2017 ČSN EN 60754-1:2015 ČSN EN 60754-2:2015 IEC/ČSN EN 60332-1-2 ČSN EN 60754-1:2015 ČSN EN 60754-2:2015 IEC/ČSN EN 61034-2	ANSI/EIA/TIA 568A, 568B ISO/IEC 11801 ČSN EN 50173-1 ed. 4:2019 IEC 60754-2 ČSN EN 60754-1:2015 ČSN EN 60754-2:2015 IEC/ČSN EN 60332-1-2 ČSN EN 60754-1:2015 ČSN EN 60754-2:2015 IEC/ČSN EN 61034-2 ČSN EN 50288-1 ed. 3:2014
CPR CERTIFICATION					
Euroclass fire rating	B2ca-s1-d1-a1	Dca-s1-d2-a1	Eca	Dca-s2-d2-a2	Dca-s2-d2-a2
Hazardous substances	-	-	-	-	-



Order code		S5131 S5231S	S5141 S5241S	S5252 S5253	S5261 S5262 S5268	S5265 S5266	S5269 S5270
Type of coaxial cable		CB 50F	CB 100F	CB 500	CB 113	CB 113 UV	CB 113 LSZH
Type		75Ω					
Class		-	-	-	CLASS A+	CLASS A+	CLASS A+
DESIGN PARAMETERS							
Internal conductor Ø [mm], mat.		0,9 Cu	1,0 Cu	0,75 Cu	1,13 Cu	1,13 Cu	1,13 Cu
Dielectric Ø [mm], type		4,4 FPE	4,6 FPE	3,2 FPE	4,8 FPE	4,8 FPE	4,8 FPE
Shielding	I.foil	1× Al	1× Al	1× Al/PES	1× Al/PES	1× Al/PES	1× Al/PES
	Conductors Ø [mm]	CuSn 32× 0,12	CuSn 48× 0,12	CuSn 48× 0,12	CuSn 144× 0,12	CuSn 144× 0,12	CuSn 144× 0,12
	II.foils	-	-	Al/PES spiral	Al/PES spiral	Al/PES spiral	Al/PES spiral
Jacket Ø [mm]		6,3±0,2	6,5±0,2	5±0,2	7,05±0,2	7,05±0,2	7,05±0,2
Material		PVC	PVC	PVC	PVC	PVC – UV resistant	LSZH
Colour		white	white	white	white	black	white
ELECTRICAL PARAMETERS							
Impedance [Ω]		75±3					
Capacity [pF/m]		56	54	53	52	52,5	52
Shortening coefficient		0,81	0,82	0,85	0,85	0,84	0,85
Maximum attenuation at 20 °C [dB/100 m]	10 MHz	2,2	2	4,5	2,2	2,28	2,2
	100 MHz	7	7	10,5	5,8	5,8	5,8
	450 MHz	14,3	14,1	20,2	12,5	12,6	12,5
	650 MHz	17,8	17,5	24,1	15,3	15,1	15,3
	860 MHz	20,8	20,5	28	18,5	17,87	18,5
	1 000 MHz	21,8	21	29,1	19,3	19,5	19,3
	2 000 MHz	32	31	>35	29,5	28,02	29,5
Maximum return loss at 20 °C [dB]	10–300 MHz	25	25	25	30	31	-
	300–600 MHz	23	23	20	25	25	25
	600–900 MHz	20	20	18	23	23	23
Min. shielding effectiveness [dB]	10–800 MHz	75	75	75	>95	>95	>95
Max. DC resistance at 20 °C [Ω/km]	Inner core	29,3	23,7	41,5	18,5	25,7	18,5
	Outer core	57,2	38,2	48,5	38,5	45,9	38,5
Insulation resistance between cores at 20 °C* [MΩ/km]		500	500	1 000	1 000	500	1 000
MECHANICAL PROPERTIES							
Weight [kg/km]		39,5	40,5	26,5	41,5	43,5	43,5
Min. bending radius single/multiple [mm]		30/60	30/60	25/50	35/70	30/60	35/70
Operating temperature [°C]	Operating	-20 ~ +75					
	During installation	+5 ~ +60					
Packaging method	Length [m]	100 250	100 250	100 250	100 250 500	100 250	250 500
	Reel type	paper	paper	paper	paper wood	paper	paper wood
	Metrage marking	yes					
RECOMMENDED CONNECTOR TYPES							
Order code	F screw-on	K7331	K7331	K7321	K7351	K7351	K7351

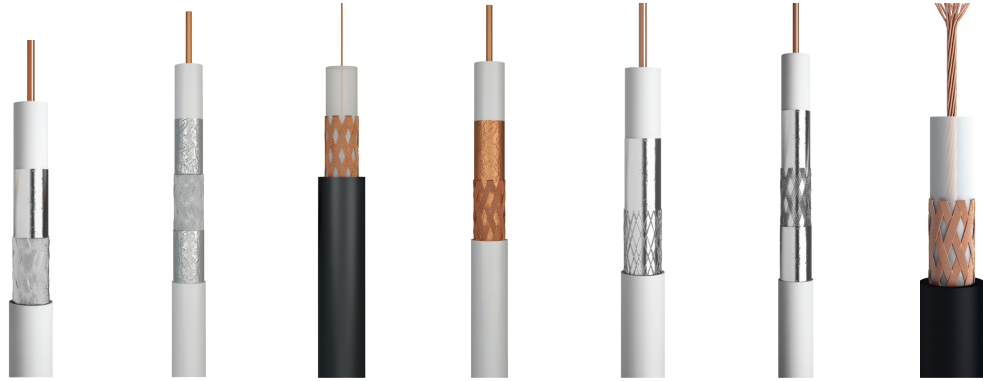

Order code	S5271 S5273	S5272	S5194	S5385	S5381 S5381E	S5382 S5383	S5213	
Type of coaxial cable	CB 21D	CB 115	RG59B/U	CB 125	CB 130	CB 135	RG58U	
Type	75Ω						50Ω	
Class	CLASS A	CLASS A	-	-	-	CLASS A	-	
DESIGN PARAMETERS								
Internal conductor Ø [mm], mat.	1,10 Cu	1,02 Cu	0,58 Cu	1,02 Cu	1,02 CCS	1,02 CCS	17× 0,19 CCA	
Dielectric Ø [mm], type	4,8 FPE	4,8 FPE	3,7 FPE	4,8 FPE	4,8 FPE	4,8 FPE	3 SPE	
Shielding	I.foil	1× Al/PET	-	1× CCA/PES	1× Al/PES	1× Al/PES	-	
	Conductors Ø [mm]	Al 128× 0,12	Al 96× 0,12	CCA 128× 0,12	CCA 64× 0,12	Al 32× 0,12	Al 64× 0,12	CCA 112× 0,12
	II.foils	-	Al/PET	-	-	-	Al/PES	-
Jacket Ø [mm]	6,8±0,2	6,8±0,2	6,05±0,2	6,8±0,2	6,8±0,2	6,8±0,2	5±0,2	
Material	PVC	PVC	PVC	PVC	PVC	PVC	PVC	
Colour	white	white	black	white	white	white	black	
ELECTRICAL PARAMETERS								
Impedance [Ω]	75±3						50±3	
Capacity [pF/m]	52	50	70	54	55	75	100	
Shortening coefficient	0,85	0,81	0,66	0,83	0,84	0,85	0,66	
Maximum attenuation at 20 °C [dB/100 m]	10 MHz	2,2	2,17	3	2,28	2,32	2,28	8,5
	100 MHz	4,2	7,35	9	7,1	7,4	7,2	14,2
	450 MHz	11,3	13,2	20	14,4	15,5	15	32,9
	650 MHz	14,8	17,42	28	17,6	18,2	18,3	47,2
	860 MHz	17,6	19,47	32	20,6	20,8	20,7	-
	1 000 MHz	18,4	19,8	-	21,3	22,5	21,9	-
	2 000 MHz	27,1	29,9	-	31,5	34	33,5	-
Maximum return loss at 20 °C [dB]	10-300 MHz	30	25	20	23	25	25	-
	300-600 MHz	25	23	16	20	23	23	18
	600-900 MHz	23	19	16	20	20	20	16
Min. shielding effectiveness [dB]	10-800 MHz	>110	>100	90	77	75	>110	65
Max. DC resistance at 20 °C [Ω/km]	Inner core	19,5	21	170	23,9	25,7	25,3	37,6
	Outer core	38,5	38	17	38,9	45,9	49,2	17,1
Insulation resistance between cores at 20 °C* [MΩ/km]	>500	500	>10 000	500	500	500	500	
MECHANICAL PROPERTIES								
Weight [kg/km]	41,5	41	55	40,5	40,5	40,5	40,5	
Min. bending radius single/multiple [mm]	35/70	30/60	25/50	30/60	30/60	30/60	25/50	
Operating temperature [°C]	Operating	-20 ~ +75						
	During installation	+5 ~ +60						
Packaging method	Length [m]	100 500	100	500	100	100	100 500	500
	Reel type	paper wood	paper	paper wood	paper	paper PVC	paper wood	wood
	Metrage marking	yes						
RECOMMENDED CONNECTOR TYPES								
Order code	F screw-on	K7351	K7351	K7331	K7351	K7331	K7331	-



City



	J0701	J0703	J0704
Order code	J0701	J0703	J0704
Use	indoor	indoor	indoor
Signal reception	FM/DAB/DVB-T/T2	DAB/DVB-T/T2	FM/DAB/DVB-T/T2
Suitable for receiving full HD broadcasts	yes	yes	yes
LTE filter	yes	yes	yes
5G filter	yes	yes	yes
Polarization	horizontal and vertical	horizontal and vertical	horizontal and vertical
Frequency bands	FM/VHF/DAB/UHF	VHF/UHF	FM/VHF/DAB/UHF
Frequency range	47-230 MHz, 470-698 MHz	174-230 MHz, 470-698 MHz	87.5-230 MHz, 470-698 MHz
Reception angle	360°	360°	360°
Power supply	DC USB 5 V/550 mA (included)	DC USB 5 V/550 mA (included)	DC USB 5 V/550 mA (included)
Connector type	IEC	IEC	IEC

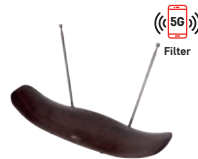

	J0705	J0708	J0709
Order code	J0705	J0708	J0709
Use	indoor	indoor	indoor
Signal reception	FM/DAB/DVB-T/T2	FM/DAB/DVB-T/T2	DAB/DVB-T/T2
Suitable for receiving full HD broadcasts	yes	yes	yes
LTE filter	yes	yes	yes
5G filter	yes	yes	yes
Polarization	horizontal and vertical	horizontal and vertical	horizontal and vertical
Frequency bands	FM/VHF/DAB/UHF	FM/VHF/DAB/UHF	VHF/UHF
Frequency range	87.5-230 MHz, 470-698 MHz	87.5-230 MHz, 470-698 MHz	174-230 MHz, 470-698 MHz
Reception angle	180°	360°	180°
Power supply	DC USB 5 V/550 mA (included)	USB 5 V/200 mA (included)	USB 5 V/200 mA (included)
Connector type	IEC	IEC	IEC



Village



	J0801	J0802	J0803
Order code	J0801	J0802	J0803
Use	universal	indoor/outdoor	indoor/outdoor
Signal reception	DVB-T/T2	FM/DAB/DVB-T/T2	FM/DAB/DVB-T/T2
Suitable for receiving full HD broadcasts	yes	yes	yes
LTE filter	yes	yes	yes
5G filter	yes	yes	yes
Polarization	horizontal and vertical	horizontal and vertical	horizontal and vertical
Frequency bands	UHF	FM/VHF/DAB/UHF	FM/VHF/UHF
Frequency range	470-698 MHz	87.5-230 MHz, 470-698 MHz	47-698 MHz
Reception angle	90°	180°	360°
Power supply	DC USB 5 V/550 mA (included)	USB 5 V/200 mA (included)	USB 5 V/200 mA (included)
Connector type	F, IEC	IEC	IEC

Village



Order code	J0806	J0804	J0685
Use	outdoor	universal	indoor/outdoor
Signal reception	DVB-T/T2	DAB/DVB-T/T2	DVB-T/T2
Suitable for receiving full HD broadcasts	yes	yes	yes
LTE filter	yes	yes	yes
5G filter	yes	yes	yes
Polarization	horizontal or vertical	horizontal and vertical	horizontal and vertical
Frequency bands	UHF	VHF/DAB/UHF	UHF
Frequency range	470–698 MHz	174–230 MHz, 470–698 MHz	470–698 MHz
Reception angle	30°/40°	180°	30°/40°
Power supply	DC 5–12 V/100 mA (included)	DC USB 5 V/550 mA (included)	DC USB 5 V/550 mA (included)
Connector type	F	F, IEC	F, IEC

Profi

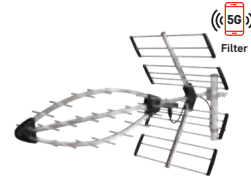
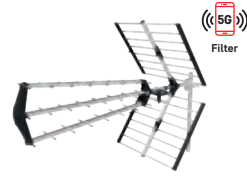

Order code	J0906	J0907	J0690	J0669
Use	outdoor YAGI	outdoor YAGI	outdoor	outdoor
Signal reception	DVB-T/T2	DVB-T/T2	DVB-T/T2	DVB-T/T2
Suitable for receiving full HD broadcasts	yes	yes	yes	yes
LTE filter	yes	yes	yes	yes
5G filter	yes	yes	yes	–
Polarization	horizontal and vertical	horizontal and vertical	horizontal and vertical	horizontal and vertical
Frequency bands	UHF	UHF	UHF	UHF
Frequency range	470–698 MHz	470–698 MHz	470–698 MHz	470–790 MHz
Reception angle	38°/80°	38°/80°	38°/80°	45°/40°
Power supply	not stated	not stated	passive	passive
Connector type	F connector	F connector	F connector	F connector



Order code	J0680	J0665	J0666
Use	outdoor	set containing antenna, preamplifier and power supply	set containing antenna, preamplifier and power supply
Signal reception	DVB-T/T2	DAB/DVB-T/T2	DAB/DVB-T/T2
Suitable for receiving full HD broadcasts	yes	yes	yes
LTE filter	yes	yes	yes
5G filter	–	–	–
Polarization	horizontal and vertical	horizontal and vertical	horizontal and vertical
Frequency bands	UHF	VHF/DAB/UHF	VHF/DAB/UHF
Frequency range	470–790 MHz	170–790 MHz	170–790 MHz
Reception angle	34°/26°	30°/40°	30°/40°
Power supply	passive	12 V/100 mA (included)	12 V/100 mA (included)
Connector type	F connector	F connector	F connector



Order code	M3620	M0305	M3216	M0230	M2092	M0391	M0320
Series	300			200			100
Type	MD-310	MD-310C	MD-300	MD-230	MD-220	MD-210	MD-110
Range selection	manual	automatic	automatic	manual	manual	manual	manual
AC voltage	200 – 300 V	2 – 600 V	2–600 V	2 – 600 V	2 – 600 V	200 – 300 V	200 – 300 V
DC voltage	200 mV – 300 V	200 mV – 600 V	200 mV – 600 V	200 mV – 600 V	200 mV – 600 V	200 mV – 300 V	200 mV – 300 V
AC current	–	–	200 μ A – 200 mA	2 mA – 10 A	2 mA – 10 A	–	–
DC current	20 mA – 10 A	2 – 600 A	200 μ A – 200 mA	2 mA – 10 A	2 mA – 10 A	20 μ A – 10 A	2 000 μ A – 200 mA
Electrical resistance	200 Ω – 2 M Ω	200 Ω – 20 M Ω	200 Ohm – 20 MOhm	200 Ω – 20 M Ω	200 Ω – 20 M Ω	200 Ω – 2 M Ω	200 Ω – 2 M Ω
Circuit continuity	yes	yes	yes	yes	yes	yes	–
Diode test	yes	yes	yes	yes	yes	yes	yes
Transistor test	–	–	–	yes	yes	–	–
Battery test	yes	–	–	–	–	–	yes
Temperature measurement	–	–	–	–	–	–	–
Touchless AC voltage detection	–	–	–	–	–	–	–
Product details	safe measuring tip connection technology	–	–	–	–	–	–



Order code	M0430	M0420	M3691	M0400
Series	400			
Type	MD-430	MD-420	MD-410	MD-410C
Range selection	automatic + manual	automatic	manual	automatic + manual
AC voltage	600 mV – 750 V	2 – 300 V	200 mV – 300 V	4 V – 600 V
DC voltage	600 mV – 1 000 V	200 μ A – 10 A (to 1 000 A)	200 mV – 300 V	400 mV – 600 V
AC current	600 μ A – 10 A	200 mV – 300 A	20 mA – 10 A	400 A
DC current	600 μ A – 10 A	200 μ A – 10 A (to 1 000 A)	20 mA – 10 A	400 A
Electrical resistance	600 Ohm – 60 MOhm	200 Ω – 20 M Ω	200 Ω – 20 M Ω	400 Ω – 40 M Ω
Circuit continuity	yes	yes	yes	yes
Diode test	yes	yes	yes	yes
Transistor test	yes	yes	–	–
Battery test	–	–	yes	–
Temperature measurement	-40 $^{\circ}$ C to +300 $^{\circ}$ C	-20 $^{\circ}$ C to +1 000 $^{\circ}$ C	0 $^{\circ}$ C to +1 000 $^{\circ}$ C	-20 $^{\circ}$ C to +1 000 $^{\circ}$ C
Touchless AC voltage detection	–	–	yes	–
Product details	maximum value memory, measured value memory	–	safe measuring tip connection technology	–



Order code	M0071	M0012A	M0014A	M0003B	M0007A	M0048	M0018
Series	700	300		200		100	
Type	VT-710	VT-320	VT-310	VT-211	VT-150	VT-120	VT-110
AC voltage	6 – 690 V	12 – 690 V	110 – 400 V	6–400 V	70 – 1 000 V touchless	70 – 250 V touchless	70 – 250 V touchless
DC voltage	6 – 690 V	12 – 690 V	110 – 400 V	6–400 V		0 – 250 V touchless	0 – 250 V touchless
Indication	optical + acoustic	optical + acoustic	optical	optical	optical + acoustic	optical + acoustic	optical
Determination of polarity	yes	yes	yes	yes	–	yes	yes
Determination of phase sequence	yes	yes	yes	–	–	–	–
Circuit continuity	yes	yes	–	–	–	–	–

Measuring tools



Order code	M0501	M0502	M0503	N0322
Name	Multidetector	Laser distance meter	IR thermometer	Universal battery tester
Product details	detection of AC wiring, metal and wood	0,05 – 40 m, length, area, volume, Pythagoras, continuous measurement	optical characteristic 8:1, laser measurement, continuous measurement, memory, -50 °C to 380 °C	for batteries AAA, AA, C, D, 9 V, button



Order code	P56110T	P56160T	P56060T	P5603R	P5614
Thermostat type	wireless with OpenTherm communication	wireless with OpenTherm communication	wired with OpenTherm communication	wire	wireless
Control mode	heating and cooling system	heating and cooling system	heating and cooling system	heating and cooling system	heating and cooling system
Number of programs	6 programs + 3 customizable	1 customizable program and customizable temperature (6× per day)	1 customizable program and customizable temperature (6× per day)	customizable temperature	customizable temperature
Temperature setting type	6 temperature changes per day	6 temperature changes per day	6 temperature changes per day	manually	manually
Temperature setting	from 7 °C up to 30 °C, by 0.2 °C	from 5 °C up to 35 °C, by 0.5 °C	from 5 °C up to 35 °C, by 0.5 °C	from 5 °C up to 30 °C, by 1 °C	from 5 °C up to 35 °C, by 0.5 °C
Adjustable variance of temperature	0.1 °C, 0.2 °C, 0.5 °C, 1.0 °C	from 0.2 °C up to 2 °C, by 0.1 °C	from 0.2 °C up to 2 °C, by 0.1 °C	0.4 °C	±0.2 °C
ON/OFF function	yes	yes	yes	–	yes
Holiday mode	–	yes	yes	–	–
Switching	230 V AC and potential-free	230 V AC and potential-free	230 V AC and potential-free	230 V AC and potential-free	230 V AC and potential-free
Switching load	16 A resistive, 5 A inductive	10 A resistive, 4 A inductive	6 A resistive, 2 A inductive	6 A resistive, 2 A inductive	16 A resistive, 4 A inductive
Power supply	230 V AC (receiver)/2× 1.5 V AA (transmitter)	230 V AC (receiver)/2× 1.5 V AA (transmitter)	2× 1.5 V AA (included)	2× 1.5 V AA (included)	230 V AC (receiver)/2× 1.5 V AAA (transmitter)
Other features	OpenTherm & relay output, lock function, illuminated display, range 100 m	OpenTherm & relay output, lock function, illuminated display, range 100 m	OpenTherm & relay output, lock function, illuminated display	freeze protection	freeze protection, illuminated display, range 100 m



Order code	P5604	P5623	P5607	P5601UF	P5660FR
Thermostat type	wire	wireless	wire	wired for underfloor heating	socket
Control mode	heating and cooling system	heating system	heating and cooling system	heating system	heating and cooling system
Number of programs	customizable temperature	customizable	1 customizable program and customizable temperature (6× per day)	1 customizable program and customizable temperature (6× per day)	customizable temperature (6× per day)
Temperature setting type	manually	6 temperature changes per day	6 temperature changes per day	6 temperature changes per day	6 temperature changes per day
Temperature setting	from 5 °C up to 35 °C, by 0.5 °C	5 °C to 35 °C, resolution 0.5 °C	from 5 °C up to 35 °C, by 0.5 °C	from 5 °C up to 95 °C, by 0.5 °C	5 °C to 40 °C, resolution 0.5 °C
Adjustable variance of temperature	±0.2 °C	±0.3 °C	from 0.2 °C up to 2 °C, by 0.1 °C	from 1 °C up to 10 °C, by 1 °C	from 0.2 °C up to 2 °C, by 0.1 °C
ON/OFF function	–	yes	–	yes	yes
Holiday mode	–	yes	–	–	–
Switching	230 V AC and potential-free	230 V AC and potential-free	230 V AC and potential-free	voltage 230 V AC, 50 Hz	230 V AC and potential-free
Switching load	8 A resistively, 2 A inductively	16 A resistive, 4 A inductive	8 A resistively, 2 A inductively	16 A resistive	16 A resistive, 4 A inductive
Power supply	2× 1.5 V AAA (included)	230 V AC (receiver)/ 5 V (transmitter)	2× 1.5 V AAA (included)	230 V AC	230 V AC
Other features	freeze protection, illuminated display	control via mobile app, Wi-Fi connection; master lock; freeze protection, range 100 m	freeze protection, illuminated display	freeze protection	freeze protection, temperature calibration, timer (countdown, summer/winter time)



Order code	P56201	P56211	P56201UF	P5630S
Thermostat type	wire	wireless	wired for underfloor heating	SMART, programmable thermo knob
Control mode	heating and cooling system	heating and cooling system	heating system	heating system
Number of programs	customizable temperature (6× per day)	customizable temperature (6× per day)	customizable temperature (6× per day)	1 customizable program and customizable temperature (6× per day)
Temperature setting type	6 temperature changes per day	6 temperature changes per day	6 temperature changes per day	6 temperature changes per day
Temperature setting	from 5 °C up to 35 °C, by 0.5 °C	from 5 °C up to 35 °C, by 0.5 °C	from 1 °C up to 70 °C, by 0.5 °C	1 °C to 70 °C, resolution 0.5 °C
Adjustable variance of temperature	0.2 °C to 2 °C (resolution 0.1 °C)	0.2 °C to 2 °C (resolution 0.1 °C)	internal sensor: 0.5 °C to 2.5 °C, resolution 0.5 °C; underfloor sensor: 1 °C to 9 °C, resolution 1 °C	from 0.5 °C up to 1.5 °C, by 0.5 °C
ON/OFF function	yes	yes	yes	-
Holiday mode	yes	yes	yes	yes
Switching	voltage 230 V AC, 50 Hz	230 V AC and potential-free	voltage 230 V AC, 50 Hz	-
Switching load	6 A resistive, 2 A inductive	16 A resistive, 4 A inductive	16 A resistive	-
Power supply	230 V AC	230 V AC (receiver)/5 V (transmitter)	230 V AC	2× 1.5 V AA (included)
Other features	freeze protection, temperature calibration, switching based on GPS location	freeze protection, temperature calibration, switching based on GPS location	freeze protection, temperature calibration, switching based on GPS location	freeze protection, temperature calibration, child lock, switching based on GPS location
Matrix	-	-	-	M30 × 1.5 mm
Included adaptors	-	-	-	Danfoss RA, RAV, RAVL



Order code	P5685	P5686	P5683	P5684	P5681	P5682
Thermostat type	wire, flow thermostat	wire, flow thermostat	wire, flow thermostat	wire, capillary sensor thermostat	wire, flow thermostat	wire, capillary sensor thermostat
Control mode	heating and cooling system	heating and cooling system	heating and cooling system	heating and cooling system	heating and cooling system	heating and cooling system
Number of programs	-	-	-	-	-	-
Temperature setting type	manually	manually	manually	manually	manually	manually
Temperature setting	0 °C to 90 °C, resolution 5 °C	from 5 °C up to 80 °C, by 0.1 °C	from 5 °C up to 80 °C, by 0.1 °C	from 5 °C up to 90 °C, by 0.1 °C	0 °C to 90 °C, resolution 5 °C	0 °C to 90 °C, resolution 5 °C
Adjustable variance of temperature	-	from 0.1 °C up to 15 °C, by 0.1 °C	from 0.1 °C up to 15 °C, by 0.1 °C	from 0.1 °C up to 15 °C, by 0.1 °C	-	-
ON/OFF function	-	yes	yes	yes	-	-
Holiday mode	-	-	-	-	-	-
Switching	voltage 230 V AC, 50 Hz	voltage 230 V AC, 50 Hz	voltage 230 V AC, 50 Hz	voltage 230 V AC, 50 Hz	voltage 230 V AC, 50 Hz	voltage 230 V AC, 50 Hz
Switching load	16 A resistive, 4 A inductive	5 A resistively, 1.5 A inductively	5 A resistively, 1.5 A inductively	5 A resistively, 1.5 A inductively	16 A resistive, 4 A inductive	16 A resistive, 4 A inductive
Power supply	230 V, 400 V AC	230 V AC	230 V AC	230 V AC	230 V, 400 V AC	230 V, 400 V AC
Other features	-	-	display with set/current temperature, LED indication of thermostat activation, ON/OFF function	display with set/current temperature, LED indication of thermostat activation, ON/OFF function	-	-

A60 SHAPE

Old model			New model			
Order code	Parameters	Energy class	Order code	Parameters	Energy class	EAN
ZQ5142	8,5 W (60 W) / 806 lm / E27 / CW	F	ZQ5E44	7 W (60 W) / 806 lm / E27 / CW	E	8 592920 126509
ZQ5152	10,7 W (75 W) / 1 060 lm / E27 / CW	F	ZQ5E54	9,5 W (75 W) / 1 055 lm / E27 / CW	E	8 592920 126592
ZQ5162	13,2 W (100 W) / 1 521 lm / E27 / CW	E	ZQ5E64	13 W (100 W) / 1 521 lm / E27 / CW	E	8 592920 126684
ZQ5130	7,3 W (50 W) / 645 lm / E27 / WW	F	ZQ5E31	5,8 W (50 W) / 645 lm / E27 / WW	E	8 592920 126387
ZQ5140	8,5 W (60 W) / 806 lm / E27 / WW	F	ZQ5E41	7 W (60 W) / 806 lm / E27 / WW	E	8 592920 126448
ZQ5140.3	8,5 W (60 W) / 806 lm / E27 / WW / 3PC	F	ZQ5E41.3	7 W (60 W) / 806 lm / E27 / WW / 3PC	E	8 592920 126714
ZQ5150	10,7 W (75 W) / 1 060 lm / E27 / WW	F	ZQ5E51	9,5 W (75 W) / 1 055 lm / E27 / WW	E	8 592920 126530
ZQ5150.3	10,7 W (75 W) / 1 060 lm / E27 / WW / 3PC	F	ZQ5E51.3	9,5 W (75 W) / 1 055 lm / E27 / WW / 3PC	E	8 592920 126837
ZQ5160	13,2 W (100 W) / 1 521 lm / E27 / WW	E	ZQ5E61	13 W (100 W) / 1 521 lm / E27 / WW	E	8 592920 126622
ZQ5160.3	13,2 W (100 W) / 1 521 lm / E27 / WW / 3PC	E	ZQ5E61.3	13 W (100 W) / 1 521 lm / E27 / WW / 3PC	E	8 592920 126899
ZQ5120	5,2 W (40 W) / 470 lm / E27 / WW	F	ZQ5E21	4 W (40 W) / 470 lm / E27 / WW	E	8 592920 126325
ZQ5131	7,3 W (50 W) / 645 lm / E27 / NW	F	ZQ5E33	5,8 W (50 W) / 645 lm / E27 / NW	E	8 592920 126417
ZQ5141	8,5 W (60 W) / 806 lm / E27 / NW	F	ZQ5E43	7 W (60 W) / 806 lm / E27 / NW	E	8 592920 126479
ZQ5141.3	8,5 W (60 W) / 806 lm / E27 / NW / 3PC	F	ZQ5E43.3	7 W (60 W) / 806 lm / E27 / NW / 3PC	E	8 592920 126776
ZQ5151	10,7 W (75 W) / 1 060 lm / E27 / NW	F	ZQ5E53	9,5 W (75 W) / 1 055 lm / E27 / NW	E	8 592920 126561
ZQ5151.3	10,7 W (75 W) / 1 060 lm / E27 / NW / 3PC	F	ZQ5E53.3	9,5 W (75 W) / 1 055 lm / E27 / NW / 3PC	E	8 592920 126868
ZQ5161	13,2 W (100 W) / 1 521 lm / E27 / NW	E	ZQ5E63	13 W (100 W) / 1 521 lm / E27 / NW	E	8 592920 126653
ZQ5161.3	13,2 W (100 W) / 1 521 lm / E27 / NW / 3PC	F	ZQ5E63.3	13 W (100 W) / 1 521 lm / E27 / NW / 3PC	E	8 592920 126929
ZQ5121	5,2 W (40 W) / 470 lm / E27 / NW	F	ZQ5E23	4 W (40 W) / 470 lm / E27 / NW	E	8 592920 126356
-	-	-	ZL4206	3× DIMM / 10,5 W (75 W) / 1 060 lm / WW	F	8 592920 044360

A67 SHAPE

A70 SHAPE

Old model			New model			
Order code	Parameters	Energy class	Order code	Parameters	Energy class	EAN
ZQ5173	17 W (120 W) / 1 900 lm / E27 / WW	E	ZQ5E71	16 W (120 W) / 1 901 lm / E27 / WW	E	8 592920 126950
ZQ5174	17 W (120 W) / 1 900 lm / E27 / NW	E	ZQ5E73	16 W (120 W) / 1 901 lm / E27 / NW	E	8 592920 126981
ZQ5175	17 W (120 W) / 1 900 lm / E27 / CW	E	ZQ5E74	16 W (120 W) / 1 901 lm / E27 / CW	E	8 592920 127018

A67 SHAPE

A80 SHAPE

Old model			New model			
Order code	Parameters	Energy class	Order code	Parameters	Energy class	EAN
ZQ5183	19 W (150 W) / 2 452 lm / E27 / WW	E	ZQ5E81	20 W (150 W) / 2 452 lm / E27 / WW	E	8 592920 127049
ZQ5184	19 W (150 W) / 2 452 lm / E27 / NW	E	ZQ5E83	20 W (150 W) / 2 452 lm / E27 / NW	E	8 592920 127070
ZQ5185	19 W (150 W) / 2 452 lm / E27 / CW	E	ZQ5E84	20 W (150 W) / 2 452 lm / E27 / CW	E	8 592920 127100

A95 SHAPE

Old model			New model			
Order code	Parameters	Energy class	Order code	Parameters	Energy class	EAN
-	-	-	ZQ5E91	28 W (200 W) / 3 452 lm / E27 / WW	E	8 592920 130803
-	-	-	ZQ5E93	28 W (200 W) / 3 452 lm / E27 / NW	E	8 592920 130834

CANDLE SHAPE

Old model			New model			
Order code	Parameters	Energy class	Order code	Parameters	Energy class	EAN
ZQ3222	5 W (40 W) / 470 lm / E14 / CW	F	ZQ3E24	4,2 W (40 W) / 470 lm / E14 / CW	E	8 592920 127254
ZQ3232	7,3 W (60 W) / 806 lm / E14 / CW	E	ZQ3E44	6,5 W (60 W) / 806 lm / E14 / CW	E	8 592920 127346
ZQ3210	4,1 W (32 W) / 350 lm / E14 / WW	F	ZQ3D11	2,5 W (32 W) / 350 lm / E14 / WW	D	8 592920 127131
ZQ3220	5 W (40 W) / 470 lm / E14 / WW	F	ZQ3E21	4,2 W (40 W) / 470 lm / E14 / WW	E	8 592920 127193
ZQ3220.3	5 W (40 W) / 470 lm / E14 / WW / 3PC	F	ZQ3E21.3	4,2 W (40 W) / 470 lm / E14 / WW / 3PC	E	8 592920 127490
ZQ3230	7,3 W (60 W) / 806 lm / E14 / WW	E	ZQ3E41	6,5 W (60 W) / 806 lm / E14 / WW	E	8 592920 127285
ZQ3211	4,1 W (32 W) / 350 lm / E14 / NW	F	ZQ3D13	2,5 W (32 W) / 350 lm / E14 / NW	D	8 592920 127162
ZQ3221	5 W (40 W) / 470 lm / E14 / NW	F	ZQ3E23	4,2 W (40 W) / 470 lm / E14 / NW	E	8 592920 127223
ZQ3221.3	5 W (40 W) / 470 lm / E14 / NW / 3PC	F	ZQ3E23.3	4,2 W (40 W) / 470 lm / E14 / NW / 3PC	E	8 592920 127520
ZQ3231	7,3 W (60 W) / 806 lm / E14 / NW	E	ZQ3E43	6,5 W (60 W) / 806 lm / E14 / NW	E	8 592920 127315
ZQ3110	4,1 W (32 W) / 350 lm / E27 / WW	F	ZQ4D11	2,5 W (32 W) / 350 lm / E27 / WW	D	8 592920 127377
ZQ3120	4,9 W (40 W) / 470 lm / E27 / WW	F	ZQ4E21	4,2 W (40 W) / 470 lm / E27 / WW	E	8 592920 127438
ZQ3111	4,1 W (32 W) / 350 lm / E27 / NW	F	ZQ4D13	2,5 W (32 W) / 350 lm / E27 / NW	D	8 592920 127407
ZQ3121	4,9 W (40 W) / 470 lm / E27 / NW	F	ZQ4E23	4,2 W (40 W) / 470 lm / E27 / NW	E	8 592920 127469

MINI GLOBE SHAPE

Old model			New model			
Order code	Parameters	Energy class	Order code	Parameters	Energy class	EAN
ZQ1222	5 W (40 W) / 470 lm / E14 / CW	F	ZQ1E24	4,2 W (40 W) / 470 lm / E14 / CW	E	8 592920 127704
ZQ1232	7,3 W (60 W) / 806 lm / E14 / CW	E	ZQ1E44	6,5 W (60 W) / 806 lm / E14 / CW	E	8 592920 127797
ZQ1210	4,1 W (32 W) / 330 lm / E14 / WW	F	ZQ1D11	2,5 W (32 W) / 350 lm / E14 / WW	D	8 592920 127551
ZQ1220	5 W (40 W) / 470 lm / E14 / WW	F	ZQ1E21	4,2 W (40 W) / 470 lm / E14 / WW	E	8 592920 127612
ZQ1220	5 W (40 W) / 470 lm / E14 / WW	F	ZQ1E21.3	4,2 W (40 W) / 470 lm / E14 / WW / 3PC	E	8 592920 127643
ZQ1230	7,3 W (60 W) / 806 lm / E14 / WW	E	ZQ1E41	6,5 W (60 W) / 806 lm / E14 / WW	E	8 592920 127735
ZQ1211	4,1 W (32 W) / 350 lm / E14 / NW	F	ZQ1D13	2,5 W (32 W) / 350 lm / E14 / NW	D	8 592920 127582
ZQ1221	5 W (40 W) / 470 lm / E14 / NW	F	ZQ1E23	4,2 W (40 W) / 470 lm / E14 / NW	E	8 592920 127674
ZQ1221	5 W (40 W) / 470 lm / E14 / NW	F	ZQ1E23.3	4,2 W (40 W) / 470 lm / E14 / NW / 3PC	E	8 592920 128060
ZQ1231	7,3 W (60 W) / 806 lm / E14 / NW	E	ZQ1E43	6,5 W (60 W) / 806 lm / E14 / NW	E	8 592920 127766
ZQ1122	5 W (40 W) / 470 lm / E27 / CW	F	ZQ6E24	4,2 W (40 W) / 470 lm / E27 / CW	E	8 592920 127940
ZQ1132	7,3 W (60 W) / 806 lm / E27 / CW	E	ZQ6E44	6,5 W (60 W) / 806 lm / E27 / CW	E	8 592920 128039
ZQ1110	4,1 W (32 W) / 350 lm / E27 / WW	F	ZQ6D11	2,5 W (32 W) / 350 lm / E27 / WW	D	8 592920 127827
ZQ1120	5 W (40 W) / 470 lm / E27 / WW	F	ZQ6E21	4,2 W (40 W) / 470 lm / E27 / WW	E	8 592920 127889
ZQ1120	5 W (40 W) / 470 lm / E27 / WW	F	ZQ6E21.3	4,2 W (40 W) / 470 lm / E27 / WW / 3PC	E	8 592920 128091
ZQ1130	7,3 W (60 W) / 806 lm / E27 / WW	E	ZQ6E41	6,5 W (60 W) / 806 lm / E27 / WW	E	8 592920 127971
ZQ1111	4,1 W (30 W) / 350 lm / E27 / NW	F	ZQ6D13	2,5 W (32 W) / 350 lm / E27 / NW	D	8 592920 127858
ZQ1121	5 W (40 W) / 470 lm / E27 / NW	F	ZQ6E23	4,2 W (40 W) / 470 lm / E27 / NW	E	8 592920 127919
ZQ1121	5 W (40 W) / 470 lm / E27 / NW	F	ZQ6E23.3	4,2 W (40 W) / 470 lm / E27 / NW / 3PC	E	8 592920 128121
ZQ1131	7,3 W (60 W) / 806 lm / E27 / NW	E	ZQ6E43	6,5 W (60 W) / 806 lm / E27 / NW	E	8 592920 128008

REFLECTOR SHAPE

Old model			New model			
Order code	Parameters	Energy class	Order code	Parameters	Energy class	EAN
ZQ7220	4 W (39 W) / 450 lm / E14 / WW	E	ZQ7E21	4,2 W (40 W) / 470 lm / E14 / WW	E	8 592920 128152
ZQ7221	4 W (39 W) / 450 lm / E14 / NW	E	ZQ7E23	4,2 W (40 W) / 470 lm / E14 / NW	E	8 592920 128183
ZQ7140	8,8 W (60 W) / 806 lm / E27 / WW	F	ZQ7E41	7 W (60 W) / 806 lm / E27 / WW	E	8 592920 128213
ZQ7141	8,8 W (60 W) / 806 lm / E27 / NW	F	ZQ7E43	7 W (60 W) / 806 lm / E27 / NW	E	8 592920 128244

GU10 SHAPE

Old model			New model			
Order code	Parameters	Energy class	Order code	Parameters	Energy class	EAN
-	-	-	ZQ8338	3 W (40 W) / 535lm / NW / A CLASS	A	8 592920 129470
ZL4780	7 W (70 W) / 580 lm / NW	F	ZQ8E33N	5,8 W (75 W) / 565 lm / NW	E	8 592920 128602
ZQ8342	3,8 W (30 W) / 320 lm / CW	G	ZQ8E14	3 W (32 W) / 345 lm / CW	E	8 592920 128336
ZQ8335	4,2 W (35 W) / 333 lm / CW	F	ZQ8E19	3 W (32 W) / 345 lm / CW	E	8 592920 128572
ZQ8372	8,4 W (60 W) / 806 lm / CW	F	ZQ8E44	7 W (60 W) / 806 lm / CW	E	8 592920 128480
ZQ8340	3,8 W (30 W) / 320 lm / WW	G	ZQ8E12	3 W (32 W) / 345 lm / WW	E	8 592920 128275
ZQ8340.3	3,8 W (30 W) / 320 lm / WW / 3PC	G	ZQ8E12.3	3 W (32 W) / 345 lm / WW / 3PC	E	8 592920 128633
ZQ8350	5,7 W (40 W) / 465 lm / WW	G	ZQ8E22	4 W (39 W) / 450 lm / WW	E	8 592920 128367
ZQ8333	4,2 W (35 W) / 333 lm / WW	F	ZQ8E17	3 W (32 W) / 345 lm / WW	E	8 592920 128510
ZQ8370	8,4 W (60 W) / 806 lm / WW	F	ZQ8E42	7 W (60 W) / 806 lm / WW	E	8 592920 128428
ZQ8370.3	8,4 W (60 W) / 806 lm / WW / 3PC	F	ZQ8E42.3	7 W (60 W) / 806 lm / WW / 3PC	E	8 592920 128664
ZQ8341	3,8 W (30 W) / 320 lm / NW	G	ZQ8E13	3 W (32 W) / 345 lm / NW	E	8 592920 128305
ZQ8351	5,7 W (40 W) / 465 lm / NW	G	ZQ8E23	4 W (39 W) / 450 lm / NW	E	8 592920 128398
ZQ8334	4,2 W (35 W) / 333 lm / NW	F	ZQ8E18	3 W (32 W) / 345 lm / NW	E	8 592920 128541
ZQ8371	8,4 W (60 W) / 806 lm / NW	F	ZQ8E43	7 W (60 W) / 806 lm / NW	E	8 592920 128459
ZQ8371.3	8,4 W (60 W) / 806 lm / NW / 3PC	F	ZQ8E43.3	7 W (60 W) / 806 lm / NW / 3PC	E	8 592920 128695
-	-	-	ZQ8155D	DIM / 7 W (60 W) / 800 lm / GU10 / WW	E	8 592920 125144
-	-	-	ZQ8255D	DIM / 7 W (60 W) / 800 lm / NW	E	8 592920 125175
ZL4301	3×DIM / 6,1 W (45 W) / 560 lm / WW	F	ZQ8155S	3×DIM / 7 W (60 W) / 800 lm / WW	E	8 592920 125205
-	-	-	ZQ8255S	3×DIM / 7 W (60 W) / 800 lm / NW	E	8 592920 125236

G9 SHAPE

Old model			New model			
Order code	Parameters	Energy class	Order code	Parameters	Energy class	EAN
-	-	-	ZQ9125D	DIM / 4,2 W (40 W) / 470 lm / WW	E	8 592920 125328
-	-	-	ZQ9225D	DIM / 4,2 W (40 W) / 470 lm / NW	E	8 592920 125359

A60 SHAPE

Old model			New model			
Order code	Parameters	Energy class	Order code	Parameters	Energy class	EAN
-	-	-	ZF5147	3,8 W (60 W) / 806 lm / E27 / WW	A	8 592920 120569
-	-	-	ZF5147.3	3,8 W (60 W) / 806 lm / E27 / WW / 3 PC	A	8 592920 120590
-	-	-	ZF5148	3,8 W (60 W) / 806 lm / E27 / NW	A	8 592920 120620
-	-	-	ZF5148.3	3,8 W (60 W) / 806 lm / E27 / NW / 3 PC	A	8 592920 120651
-	-	-	ZF5157	5 W (75 W) / 1 060 lm / E27 / WW	A	8 592920 120682
-	-	-	ZF5157.3	5 W (75 W) / 1 060 lm / E27 / WW / 3 PC	A	8 592920 120712
-	-	-	ZF5158	5 W (75 W) / 1 060 lm / E27 / NW	A	8 592920 120743
-	-	-	ZF5158.3	5 W (75 W) / 1 060 lm / E27 / NW / 3 PC	A	8 592920 120774
-	-	-	ZF5167	7,2 W (100 W) / 1 521 lm / E27 / WW	A	8 592920 126103
-	-	-	ZF5168	7,2 W (100 W) / 1 521 lm / E27 / NW	A	8 592920 126134
Z74284	11 W (100 W) / 1 521 lm / E27 / WW	D	ZF5D62	10,5 W (100 W) / 1 521 lm / E27 / WW	D	8 592920 129890
ZF5120	3,4 W (40 W) / 470 lm / E27 / WW	D	ZF5D22	3,4 W (40 W) / 470 lm / E27 / WW	D	8 592920 129715
ZF5140	5,9 W (60 W) / 806 lm / E27 / WW	D	ZF5D42	5,9 W (60 W) / 806 lm / E27 / WW	D	8 592920 129777
ZF5140.2	5,9 W (60 W) / 806 lm / E27 / WW / 2 PC	D	ZF5D42.2	5,9 W (60 W) / 806 lm / E27 / WW / 2 PC	D	8 592920 130049
ZF5150	7,8 W (75 W) / 1 060 lm / E27 / WW	D	ZF5D52	7,8 W (75 W) / 1 060 lm / E27 / WW	D	8 592920 129838
Z74285	11 W (100 W) / 1 521 lm / E27 / NW	D	ZF5D63	10,5 W (100 W) / 1 521 lm / E27 / NW	D	8 592920 129920
ZF5121	3,4 W (40 W) / 470 lm / E27 / NW	D	ZF5D23	3,4 W (40 W) / 470 lm / E27 / NW	D	8 592920 129746
ZF5141	5,9 W (60 W) / 806 lm / E27 / NW	D	ZF5D43	5,9 W (60 W) / 806 lm / E27 / NW	D	8 592920 129807
ZF5151	7,8 W (75 W) / 1 060 lm / E27 / NW	D	ZF5D53	7,8 W (75 W) / 1 060 lm / E27 / NW	D	8 592920 129869
Z74270D	DIM / 8,5 W (75 W) / 1055 lm / WW	E	ZF5154D	DIM / 7,5 W (75 W) / 1 055 lm / E27 / WW	D	8 592920 12059
-	-	-	ZF5254D	DIM / 7,5 W (75 W) / 1 055 lm / E27 / NW	D	8 592920 125298
-	-	-	ZF5164D	DIM / 11 W (100 W) / 1 521 / lm / E27 / WW	D	8 592920 125083
-	-	-	ZF5264D	DIM / 11 W (100 W) / 1 521 / lm / E27 / NW	D	8 592920 125113

CANDLE SHAPE

Old model			New model			
Order code	Parameters	Energy class	Order code	Parameters	Energy class	EAN
ZF3200	1,8 W (25 W) / 250 lm / E14 / WW	D	ZF3D02	1,8 W (25 W) / 250 lm / E14 / WW	D	8 592920 130018
ZF3220	3,4 W (40 W) / 470 lm / E14 / WW	D	ZF3D22	3,4 W (40 W) / 470 lm / E14 / WW	D	8 592920 130100
ZF3240	6 W (60 W) / 810 lm / E14 / WW	D	ZF3D42	5,9 W (60 W) / 806 lm / E14 / WW	D	8 592920 130162
ZF3201	1,8 W (25 W) / 250 lm / E14 / NW	D	ZF3D03	1,8 W (25 W) / 250 lm / E14 / NW	D	8 592920 130070
ZF3221	3,4 W (40 W) / 470 lm / E14 / NW	D	ZF3D23	3,4 W (40 W) / 470 lm / E14 / NW	D	8 592920 130131
ZF3241	6 W (60 W) / 810 lm / E14 / NW	D	ZF3D43	5,9 W (60 W) / 806 lm / E14 / NW	D	8 592920 130193

A70 SHAPE

Old model			New model			
Order code	Parameters	Energy class	Order code	Parameters	Energy class	EAN
Z74290	17 W (150 W) / 2 452 lm / E27 / WW	D	ZF5D82	18 W (150 W) / 2 452 lm / E27 / WW	D	8 592920 129951
Z74291	17 W (150 W) / 2 452 lm / E27 / NW	D	ZF5D83	18 W (150 W) / 2 452 lm / E27 / NW	D	8 592920 129982

MINI GLOBE SHAPE

Old model			New model			
Order code	Parameters	Energy class	Order code	Parameters	Energy class	EAN
ZF1240	6 W (60 W) / 810 lm / E14 / WW	D	ZF1D42	5,9 W (60 W) / 806 lm / E14 / WW	D	8 592920 130346
ZF1221	3,4 W (40 W) / 470 lm / E14 / NW	D	ZF1D23	3,4 W (40 W) / 470 lm / E14 / NW	D	8 592920 130315
ZF1241	6 W (60 W) / 810 lm / E14 / NW	D	ZF1D43	5,9 W (60 W) / 806 lm / E14 / NW	D	8 592920 130377
ZF1100	1,8 W (25 W) / 250 lm / E27 / WW	D	ZF6D02	1,8 W (25 W) / 250 lm / E27 / WW	D	8 592920 130407
ZF1200	1,8 W (25 W) / 250 lm / E14 / WW	D	ZF1D02	1,8 W (25 W) / 250 lm / E14 / WW	D	8 592920 130223
ZF1220	3,4 W (40 W) / 470 lm / E14 / WW	D	ZF1D22	3,4 W (40 W) / 470 lm / E14 / WW	D	8 592920 130285
ZF1201	1,8 W (25 W) / 250 lm / E14 / NW	D	ZF1D03	1,8 W (25 W) / 250 lm / E14 / NW	D	8 592920 130254
ZF1120	3,4 W (40 W) / 470 lm / E27 / WW	D	ZF6D22	3,4 W (40 W) / 470 lm / E27 / WW	D	8 592920 130469
ZF1140	6 W (60 W) / 810 lm / E27 / WW	D	ZF6D42	5,9 W (60 W) / 806 lm / E27 / WW	D	8 592920 130520
ZF1101	1,8 W (25 W) / 250 lm / E27 / NW	D	ZF6D03	1,8 W (25 W) / 250 lm / E27 / NW	D	8 592920 130438
ZF1121	3,4 W (40 W) / 470 lm / E27 / NW	D	ZF6D23	3,4 W (40 W) / 470 lm / E27 / NW	D	8 592920 130490
ZF1141	6 W (60 W) / 810 lm / E27 / NW	D	ZF6D43	5,9 W (60 W) / 806 lm / E27 / NW	D	8 592920 130551

GLOBE SHAPE

Old model			New model			
Order code	Parameters	Energy class	Order code	Parameters	Energy class	EAN
ZF2150	7,8 W (75 W) / 1055 lm / E27 / WW	D	ZF2D52	7,8 W (75 W) / 1055 lm / E27 / WW	D	8 592920 130582
ZF2151	7,8 W (75 W) / 1055 lm / E27 / NW	D	ZF2D53	7,8 W (75 W) / 1055 lm / E27 / NW	D	8 592920 130605
ZF2160	11 W (100 W) / 1 521 lm / E27 / WW	D	ZF2D62	11 W (100 W) / 1 521 lm / E27 / WW	D	8 592920 130629
ZF2180	18 W (150 W) / 2 452 lm / E27 / WW	D	ZF2D82	18 W (150 W) / 2 452 lm / E27 / WW	D	8 592920 130667
ZF2161	11 W (100 W) / 1 521 lm / E27 / NW	D	ZF2D63	11 W (100 W) / 1 521 lm / E27 / NW	D	8 592920 130643
ZF2181	18 W (150 W) / 2 452 lm / E27 / NW	D	ZF2D83	18 W (150 W) / 2 452 lm / E27 / NW	D	8 592920 130681

HIGH POWER SHAPE

Old model			New model			
Order code	Parameters	Energy class	Order code	Parameters	Energy class	EAN
ZL5751	LED / CLS / T140 / 44,5 W (270 W) / 4 850 lm / E27 / NW	F	ZF5751	LED / FLM / ED90 / 36 W (327 W) / 6 000 lm / E27 / NW	C	8 592920 131732
ZL5754	LED / CLS / T140 / 44,5 W (270 W) / 4 850 lm / E40 / NW	F	ZF5754	LED / FLM / ED90 / 36 W (327 W) / 6 000 lm / E40 / NW	C	8 592920 131718

A60 SHAPE

Old model			New model			
Order code	Parameters	Energy class	Order code	Parameters	Energy class	EAN
ZL4010	8,5 W (60 W) / 806 lm / E27 / WW	F	ZL5F42	8,5 W (60 W) / 806 lm / E27 / WW	F	8 592920 134054
-	-	-	ZL5F42.3	8,5 W (60 W) / 806 lm / E27 / WW / 3 PC	F	8 592920 134238
-	-	-	ZL5F42.6	8,5 W (60 W) / 806 lm / E27 / WW / 6 PC	F	8 592920 134290
ZL4013	11 W (75 W) / 1 055 lm / E27 / WW	F	ZL5E52	9,5 W (75 W) / 1 055 lm / E27 / WW	E	8 592920 134115
ZL4018	15,3 W (100 W) / 1 521 lm / E27 / WW	F	ZL5E62	13 W (100 W) / 1 521 lm / E27 / WW	E	8 592920 134177
ZL4011	8,5 W (60 W) / 806 lm / E27 / NW	F	ZL5F43	8,5 W (60 W) / 806 lm / E27 / NW	F	8 592920 134085
-	-	-	ZL5F43.3	8,5 W (60 W) / 806 lm / E27 / NW / 3 PC	F	8 592920 134269
-	-	-	ZL5F43.6	8,5 W (60 W) / 806 lm / E27 / NW / 6 PC	F	8 592920 134313
ZL4014	11 W (75 W) / 1 055 lm / E27 / NW	F	ZL5E53	9,5 W (75 W) / 1 055 lm / E27 / NW	E	8 592920 134146
ZL4019	15,3 W (100 W) / 1 521 lm / E27 / NW	F	ZL5E63	13 W (100 W) / 1 521 lm / E27 / NW	E	8 592920 134207

CANDLE SHAPE





Old model			New model			
Order code	Parameters	Energy class	Order code	Parameters	Energy class	EAN
ZL4102	6 W (42 W) / 500 lm / E14 / WW	F	ZL3F22	4,8 W (40 W) / 470 lm / E14 / WW	F	8 592920 134337
ZL4108	6 W (42 W) / 510 lm / E27 / WW	F	ZL4F22	4,8 W (40 W) / 470 lm / E27 / WW	F	8 592920 134368
ZL4116	8,3 W (66 W) / 900 lm / E14 / WW	F	ZL3F42	8,5 W (60 W) / 806 lm / E14 / WW	F	8 592920 134399
ZL4117	8,3 W (66 W) / 900 lm / E14 / NW	F	ZL3F43	8,5 W (60 W) / 806 lm / E14 / NW	F	8 592920 134429
-	-	-	ZL3F23	4,8 W (40 W) / 470 lm / E14 / NW	F	8 592920 134788

MINI GLOBE SHAPE







Old model			New model			
Order code	Parameters	Energy class	Order code	Parameters	Energy class	EAN
ZL3904	9,4 W (60 W) / 806 lm / E14 / WW	F	ZL1F22	4,8 W (40 W) / 470 lm / E14 / WW	F	8 592920 134450
ZL3907	9,4 W (60 W) / 806 lm / E14 / WW	F	ZL6F22	4,8 W (40 W) / 470 lm / E27 / WW	F	8 592920 134481
ZL3911	9,4 W (60 W) / 806 lm / E14 / WW	F	ZL1F42	8,5 W (60 W) / 806 lm / E14 / WW	F	8 592920 134511
ZL3912	8,3 W (66 W) / 900 lm / E14 / NW	F	ZL1F43	8,5 W (60 W) / 806 lm / E14 / NW	F	8 592920 134542
-	-	-	ZL1F23	4,8 W (40 W) / 470 lm / E14 / NW	F	8 592920 134726
-	-	-	ZL6F23	4,8 W (40 W) / 470 lm / E27 / NW	F	8 592920 134757

GU10 SHAPE







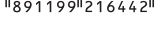

Old model			New model			
Order code	Parameters	Energy class	Order code	Parameters	Energy class	EAN
Z75060	3,3 W (21 W) / 205 lm / GU10 / NW	F	ZL8F03	2,9 W (25 W) / 250 lm / GU10 / NW	F	8 592920 134603
Z75040	3,3 W (21 W) / 200 lm / GU10 / WW	F	ZL8F02	2,9 W (25 W) / 250 lm / GU10 / WW	F	8 592920 134573
Z75130	5,8 W (40 W) / 470 lm / GU10 / WW	F	ZL8F22	5,5 W (42 W) / 500 lm / GU10 / WW	F	8 592920 134634
Z75140	5,8 W (42 W) / 500 lm / GU10 / NW	F	ZL8F23	5,5 W (42 W) / 500 lm / GU10 / NW	F	8 592920 134665

Old model			New model			
Order code	Parameters	Energy class	Order code	Parameters	Energy class	EAN
Z74300	CANDLE / 2,1 W (20 W) / 190 lm / E14 / WW+	F	Z53012	CANDLE / 2,5 W (20 W) / 225 lm / E14 / WW+	F	 8 592920 133828
Z74301	A60 / 4,3 W (35 W) / 400 lm / E27 / WW+	E	Z55032	A60 / 4,5 W (35 W) / 420 lm / E27 / WW+	F	 8 592920 133927
Z74302	ST64 / 4 W (40 W) / 470 lm / E27 / WW+	F	Z57032	ST64 / 4,5 W (40 W) / 420 lm / E27 / WW+	F	 8 592920 133859
Z74303	G125 / 4 W (40 W) / 470 lm / E27 / WW+	E	Z58032	G125 / 4,5 W (40 W) / 420 lm / E27 / WW+	F	 8 592920 133880
Z74304	G95 / 4 W (40 W) / 470 lm / E27 / WW+	E	Z52032	G95 / 4,5 W (40 W) / 420 lm / E27 / WW+	F	 8 592920 133903





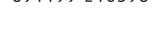

Ultra Plus

Old model		New model			
Order code	Battery type	Order code	Parameters	Battery type	EAN
B17112	AAA	B03112	voltage: 1.5 V; price for quantity: price per 1 pc; packaging: 2 pcs, small paper box	AAA	 4 891199 218163
B1711	AAA	B03114	voltage: 1.5 V; price for quantity: price per 1 pc; packaging: 4 pcs, small paper box	AAA	 4 891199 203985
B17212	AA	B03212	voltage: 1.5 V; price for quantity: price per 1 pc; packaging: 2 pcs, small paper box	AA	 4 891199 216633
B1721	AA	B03214	voltage: 1.5 V; price for quantity: price per 1 pc; packaging: 4 pcs, small paper box	AA	 4 891199 203923
B1731	C	B03312	voltage: 1.5 V; price for quantity: price per 1 pc; packaging: 2 pcs, small paper box	C	 4 891199 217654
B1741	D	B03412	voltage: 1.5 V; price for quantity: price per 1 pc; packaging: 2 pcs, small paper box	D	 4 891199 220159
B1751	9 V	B03511	voltage: 9 V; price for quantity: price per 1 pc; packaging: 1 pc, small paper box	9 V	 4 891199 216442





Ultra

Old model		New model			
Order code	Battery type	Order code	Parameters	Battery type	EAN
B1911MM	AAA	B0211V	voltage: 1.5 V; price for quantity: price per 1 pc; packaging: 6 pcs, small paper box	AAA	 4 891199 218347
B19118	AAA	B02118	voltage: 1.5 V; price for quantity: price per 1 pc; packaging: 8 pcs, small paper box	AAA	 4 891199 219603
B1911	AAA	B02114	voltage: 1.5 V; price for quantity: price per 1 pc; packaging: 4 pcs, small paper box	AAA	 4 891199 218255
B1921	AA	B02214	voltage: 1.5 V; price for quantity: price per 1 pc; packaging: 4 pcs, small paper box	AA	 4 891199 217357
B1921MM	AA	B0221V	voltage: 1.5 V; price for quantity: price per 1 pc; packaging: 6 pcs, small paper box	AA	 4 891199 217388
B19218	AA	B02218	voltage: 1.5 V; price for quantity: price per 1 pc; packaging: 8 pcs, small paper box	AA	 4 891199 219665
B1931	C	B02312	voltage: 1.5 V; price for quantity: price per 1 pc; packaging: 2 pcs, small paper box	C	 4 891199 217753
B1941	D	B02412	voltage: 1.5 V; price for quantity: price per 1 pc; packaging: 2 pcs, small paper box	D	 4 891199 220166
B1951	9 V	B02511	voltage: 9 V; price for quantity: price per 1 pc; packaging: 1 pc, small paper box	9 V	 4 891199 216398









Super

Old model		New model			
Order code	Battery type	Order code	Parameters	Battery type	EAN
B1310	AAA	B01102	voltage: 1.5 V; price for quantity: price per 1 pc; packaging: 2 pcs, shrink	AAA	
B1311	AAA	B01114	voltage: 1.5 V; price for quantity: price per 1 pc; packaging: 4 pcs, small paper box	AAA	
B13118	AAA	B01118	voltage: 1.5 V; price for quantity: price per 1 pc; packaging: 8 pcs, small paper box	AAA	
B1310G	AAA	B0111G	voltage: 1.5 V; price for quantity: price per 1 pc; packaging: 10 pc, small paper box	AAA	
B1310L	AAA	B0110L	voltage: 1.5 V; price for quantity: price per 1 pc; packaging: 20 pcs, shrink	AAA	
B1310T2	AAA	B0114T	voltage: 1.5 V; price for quantity: price per 1 pc; packaging: 288 pcs, display box	AAA	
B1320	AA	B01202	voltage: 1.5 V; price for quantity: price per 1 pc; packaging: 2 pcs, shrink	AA	
B1321	AA	B01214	voltage: 1.5 V; price for quantity: price per 1 pc; packaging: 4 pcs, small paper box	AA	
B13218	AA	B01218	voltage: 1.5 V; price for quantity: price per 1 pc; packaging: 8 pcs, small paper box	AA	
B1320G	AA	B0121G	voltage: 1.5 V; price for quantity: price per 1 pc; packaging: 10 pc, small paper box	AA	
B1320L	AA	B0120L	voltage: 1.5 V; price for quantity: price per 1 pc; packaging: 20 pcs, shrink	AA	
B1320T2	AA	B0124T	voltage: 1.5 V; price for quantity: price per 1 pc; packaging: 288 pcs, display box	AA	
B1331	C	B01312	voltage: 1.5 V; price for quantity: price per 1 pc; packaging: 2 pcs, small paper box	C	
B1330	C	B01302	voltage: 1.5 V; price for quantity: price per 1 pc; packaging: 2 pcs, shrink	C	
B13304	C	B01304	voltage: 1.5 V; price for quantity: price per 1 pc; packaging: 4 pcs, shrink	C	
B1341	D	B01412	voltage: 1.5 V; price for quantity: price per 1 pc; packaging: 2 pcs, small paper box	D	
B1340	D	B01402	voltage: 1.5 V; price for quantity: price per 1 pc; packaging: 2 pcs, shrink	D	
B13404	D	B01404	voltage: 1.5 V; price for quantity: price per 1 pc; packaging: 4 pcs, shrink	D	
B1351	9 V	B01511	voltage: 9 V; price for quantity: price per 1 pc; packaging: 1 pc, small paper box	9 V	
B1350	9 V	B01501	voltage: 9 V; price for quantity: price per 1 pc; packaging: 1 pc, shrink	9 V	

Recyko Pro

Old model		New model			
Order code	Battery type	Order code	Parameters	Battery type	EAN
B22184	AAA	B26184	voltage: 1.2 V; capacity: 800 mAh; number of charging cycles: more than 1 500; price for quantity: price per 1 pc; packaging: 4 pcs, small paper box	AAA	
B2218V	AAA	B2618V	voltage: 1.2 V; capacity: 800 mAh; number of charging cycles: more than 1 500; price for quantity: price per 1 pc; packaging: 6 pcs, small paper box	AAA	
B22204	AA	B26204	voltage: 1.2 V; capacity: 2 000 mAh; number of charging cycles: more than 1 500; price for quantity: price per 1 pc; packaging: 4 pcs, small paper box	AA	
B2220V	AA	B2620V	voltage: 1.2 V; capacity: 2 000 mAh; number of charging cycles: more than 1 500; price for quantity: price per 1 pc; packaging: 6 pcs, small paper box	AA	
B2420	AA	B2629	voltage: 1.2 V; capacity: 2 000 mAh; number of charging cycles: more than 500; price for quantity: price per 1 pc; packaging: 4 pcs, small paper box	AA	

Recyko

Old model		New model			
Order code	Battery type	Order code	Parameters	Battery type	EAN
B21114	AAA	B25114	voltage: 1.2 V; capacity: 950 mAh; number of charging cycles: more than 500; price for quantity: price per 1 pc; packaging: 4 pcs, small paper box	AAA	 4 891199 212635
B2111V	AAA	B2511V	voltage: 1.2 V; capacity: 950 mAh; number of charging cycles: more than 500; price for quantity: price per 1 pc; packaging: 6 pcs, small paper box	AAA	 4 891199 222351
B2111	AAA	B25112	voltage: 1.2 V; capacity: 950 mAh; number of charging cycles: more than 500; price for quantity: price per 1 pc; packaging: 2 pcs, small paper box	AAA	 4 891199 212628
-	-	B25182	voltage: 1.2 V; capacity: 850 mAh; number of charging cycles: more than 500; price for quantity: price per 1 pc; packaging: 2 pcs, small paper box	AAA	 4 891199 212642
-	-	B25184	voltage: 1.2 V; capacity: 850 mAh; number of charging cycles: more than 500; price for quantity: price per 1 pc; packaging: 2 pcs, small paper box	AAA	 4 891199 212659
B2116	AAA	B25162	voltage: 1.2 V; capacity: 650 mAh; number of charging cycles: more than 1 000; price for quantity: price per 1 pc; packaging: 2 pcs, small paper box	AAA	 4 891199 212666
B2127	AA	B25272	voltage: 1.2 V; capacity: 2 600 mAh; number of charging cycles: more than 300; price for quantity: price per 1 pc; packaging: 2 pcs, small paper box	AA	 4 891199 212567
B21274	AA	B25274	voltage: 1.2 V; capacity: 2 600 mAh; number of charging cycles: up to 300; price for quantity: price per 1 pc; packaging: 4 pcs, small paper box	AA	 4 891199 212574
B2127V	AA	B2527V	voltage: 1.2 V; capacity: 2 600 mAh; number of charging cycles: up to 300; price for quantity: price per 1 pc; packaging: 6 pcs, small paper box	AA	 4 891199 222368
B2121	AA	B25212	voltage: 1.2 V; capacity: 2 100 mAh; number of charging cycles: more than 500; price for quantity: price per 1 pc; packaging: 2 pcs, small paper box	AA	 4 891199 212581
-	-	B25214	voltage: 1.2 V; capacity: 2 100 mAh; number of charging cycles: more than 500; price for quantity: price per 1 pc; packaging: 4 pcs, small paper box	AA	 4 891199 212598
B2121V	AA	B2521V	voltage: 1.2 V; capacity: 2 100 mAh; number of charging cycles: more than 500; price for quantity: price per 1 pc; packaging: 6 pcs, small paper box	AA	 4 891199 222375
B2123	AA	B25232	voltage: 1.2 V; capacity: 1 300 mAh; number of charging cycles: more than 500; price for quantity: price per 1 pc; packaging: 2 pcs, small paper box	AA	 4 891199 212604
B2133	C	B2533	voltage: 1.2 V; capacity: 3 000 mAh; number of charging cycles: more than 1 000; price for quantity: price per 1 pc; packaging: 2 pcs, small paper box	C	 4 891199 212697
B2145	D	B2543	voltage: 1.2 V; capacity: 3 000 mAh; number of charging cycles: more than 1 000; price for quantity: price per 1 pc; packaging: 2 pcs, small paper box	D	 4 891199 212703
B2152	9 V	B2552	voltage: 8.4 V; capacity: 200 mAh; number of charging cycles: more than 500; price for quantity: price per 1 pc; packaging: 1 pc, small paper box	9 V	 4 891199 212710

Explanatory notes and useful links



Children's safety plugs

This icon in the catalogue refers to the presence of children's safety plugs in outlets of extension cords or surge protections.



E-shop for Business Partners

We have an e-shop for business partners at <https://en.b2b.emos.cz>.
Take advantage of the benefits of online purchasing of our products anywhere you need.



Manuals for Goods

<https://www.emos.eu/download>

Here you can find all manuals for goods we have available, even for items no longer on offer. Manuals can also be downloaded from the product details.

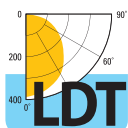

Photometric data

<https://www.emos.eu/download>

Here you can find photometric data for processing lighting projects using software tools such as DIALUX or RELUX.



A/ B/ C/ D

Packaging

A – retail packaging
B – number of products in a group packaging
C – number of products per inner carton
D – number of products per export carton





Making Life Easy

EMOS spol. s r.o.
Lipnická 2844
750 02 Prerov
Czech Republic

e-mail: emos@emos.cz
phone: +420 581 261 111

www.emos.eu/en

Y11099

